

SIMATIC HMI

Touch Panel TP 070

Equipment Manual

Preface, Contents

Introduction **1**

Functionality **2**

Commissioning **3**

Operating the TP 070 **4**

Operation of Screen Objects **5**

System Settings **6**

Communication **7**

Installation **8**

Unit Description **9**

Maintenance/Upkeep **10**

Operating System Update **11**

A

Appendices **▽**

D

Glossary, Index

6AV6591-1DC01-1AB0

Release 03/00

Safety Guidelines

This manual contains notices which you should observe to ensure your own personal safety, as well as to protect the product and connected equipment. These notices are highlighted in the manual by a warning triangle and are marked as follows according to the level of danger:



Warning

indicates that death, severe personal injury or substantial property damage **can** result if proper precautions are not taken.



Caution

indicates that minor personal injury or property damage can result if proper precautions are not taken.

Note

draws your attention to particularly important information on the product, handling the product, or to a particular part of the documentation.

Qualified Personnel

Equipment may be commissioned and operated only by **qualified personnel**. Qualified personnel within the meaning of the safety notices in this manual are persons who are authorized to commission, ground and identify equipment, systems and circuits in accordance with safety engineering standards.

Correct Usage

Note the following:



Warning

The equipment may be used only for the applications stipulated in the catalog and in the technical description and only in conjunction with other equipment and components recommended or approved by Siemens.

Startup must not take place until it is established that the machine, which is to accommodate this component, is in conformity with the guideline 89/392/EEC.

Faultless and safe operation of the product presupposes proper transportation, proper storage, erection and installation as well as careful operation and maintenance.

Trademarks

The registered trademarks of Siemens AG are listed in the Preface.

Some of the other designations used in these documents are also registered trademarks; the owner's rights may be violated if they are used by third parties for their own purposes.

Impressum

Editor and Publisher: A&D PT1.

Copyright Siemens AG 2000 All rights reserved

The reproduction, transmission or use of this document or its contents is not permitted without express written authority. Offenders will be liable for damages. All rights, including rights created by patent grant or registration of an utility model or design, are reserved.

Siemens AG
Automation & Drives
SIMATIC Human Machine Interface
Postfach 4848, D-90327 Nürnberg

Disclaimer of Liability

We have checked the contents of this manual for agreement with the hardware and software described. Since deviations cannot be precluded entirely, we cannot guarantee full agreement. However, the data in this manual are reviewed regularly and any necessary corrections included in subsequent editions. Suggestions for improvement are welcomed.

© Siemens AG 2000
Technical data subject to change.

Preface

This manual

The TP 070 equipment manual is part of the SIMATIC HMI documentation. It provides operation, installation, configuration and system personnel with information concerning installation, functionality, operation and technical design of the TP 070.

An overview of the entire SIMATIC HMI documentation is provided in appendix D.

Organization of the manual

The TP 070 equipment manual is organized into the following chapters:

Chapter	Contents
1 - 2	Overview of features and functional scope of the TP 070.
3 - 7	Commissioning, operation, system settings and communication.
8 - 10	Mechanical and electrical installation, unit description, as well as maintenance and upkeep of the TP 070.
11	Information on the operating system update.
Appendix	<ul style="list-style-type: none">• Technical Data• Interface Assignments• ESD Guidelines• SIMATIC HMI Documentation

Conventions

The following conventions are used throughout this manual:

<i>Motor off</i>	Text in the operating unit display is presented in this typewriter font.
<i>Tag</i>	Symbolic names representing tag values on the screen are presented in this italic typewriter font.
<i>Screens</i>	Functions available for selection are presented in this italic font.
ESC	The names of keys and buttons are displayed in a different font.

History

The various releases of this manual correspond to the following versions of the STEP 7-Micro/WIN 32 and STEP 7-Micro/WIN 32 Toolbox configuration software:

Release	Comment	Micro/WIN 32 version	Micro/WIN 32 Toolbox version
03/00	First release of the TP 070 equipment manual.	From Version 3.1	From Version 1.0

Trademarks

The following names are registered trademarks of the Siemens AG:

- SIMATIC®
- SIMATIC HMI®
- HMI®
- ProTool®
- ProTool/Lite®
- ProTool/Pro®
- SIMATIC Multi Panel®
- SIMATIC Multifunctional Platform®
- MP 270®
- ProAgent®

Other support

In the case of technical queries, please contact the Siemens representatives in the subsidiaries and branches responsible for your area.

SIMATIC Customer Support Hotline

Available worldwide, at all times:

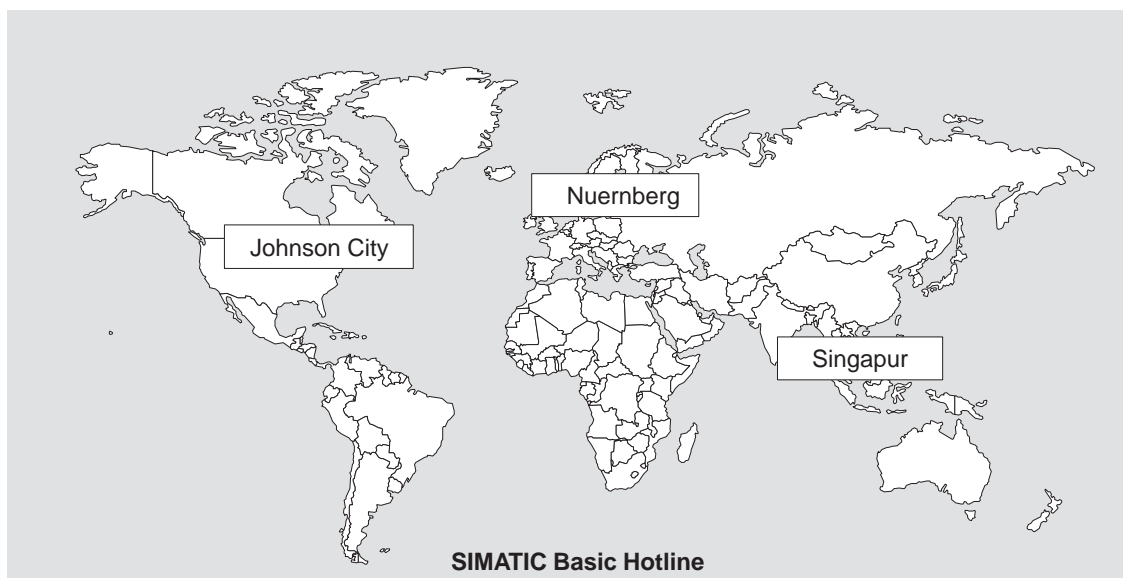

Nuernberg

SIMATIC BASIC Hotline

Local time Mo - Fr 7:00 to 17:00

Telephone: +49 (911) 895-7000

Fax: +49 (911) 895-7002

E-Mail: simatic.support@nbgm.siemens.de

Johnson City

SIMATIC BASIC Hotline

Local time Mo - Fr 8:00 to 19:00

Telephone: +1 423 461-2522

Fax: +1 423 461-2231

E-Mail: simatic.hotline@sea.siemens.com

Singapur

SIMATIC BASIC Hotline

Local time Mo - Fr 8:30 to 17:30

Telephone: +65 740-7000

Fax: +65 740-7001

E-Mail: simatic.hotline@sae.siemens.com.sg

SIMATIC Premium Hotline

(charged, only with SIMATIC Card)

Time: Mo - Fr 0:00 to 24:00

Telephone: +49 (911) 895-7777

Fax: +49 (911) 895-7001

SIMATIC Customer Online Services

SIMATIC Customer Support offers comprehensive additional information concerning SIMATIC products through its Online services as follows:

- Up-to-date general information is provided
 - in **Internet** under <http://www.ad.siemens.de/simatic>
 - via the **Fax-Polling** under 08765-93 02 77 95 00
- Up-to-date product information and downloads for practical use can be found:
 - in **Internet** under <http://www.ad.siemens.de/support/html-00/>

Abbreviations

The abbreviations used in this equipment manual have the following meaning:

CCFL	Cold Cathode Fluorescence Lamp
CPU	Central Processing Unit
ESD	Electrostatic Sensitive Device
HMI	Human Machine Interface
IF	Interface
LCD	Liquid Crystal Display
MPI	Multipoint Interface (SIMATIC S7)
PC	Personal Computer
PLC	Programmable Logic Control
PPI	Point to Point Interface (SIMATIC S7)
PU	Programming Unit
RISC	Reduced Instruction Set Computing
STN	Super Twisted Nematic
TP	Touch Panel

A list of all the specialist terms together with their explanations is provided in the glossary at the end of this manual.

Contents

1	Introduction	1-1
2	Functionality	2-1
3	Commissioning	3-1
3.1	Initial Startup	3-2
3.2	Recommissioning	3-3
3.3	Test Configuration	3-3
4	Operating the TP 070	4-1
4.1	Operating Touch Elements	4-2
4.2	Entering Values	4-4
4.3	Operating Screens	4-6
5	Operation of Screen Objects	5-1
5.1	Overview of Screen Objects	5-2
5.2	Status Button	5-3
6	System Settings	6-1
6.1	Setting an Operating Mode	6-2
6.2	Screen Settings	6-3
6.3	Deactivate Screen	6-5
7	Communication Management for SIMATIC S7	7-1
7.1	Basic Methods of Functioning	7-2
7.2	Connection to S7-200 via MPI	7-3
7.3	Optimization	7-6
8	Installation	8-1
8.1	Mechanical Installation	8-2
8.2	Electrical Installation	8-4
8.2.1	Connect configuration computer	8-7
8.2.2	Connect PLC	8-8
9	Unit Description	9-1
9.1	Dimensions	9-2
9.2	Connection Elements	9-3
9.3	Communication Options	9-4

10	Maintenance/Upkeep	10-1
11	Operating System Update	11-1
Appendix		
A	Technical Data	A-1
B	Interface Assignment	B-1
C	ESD Guidelines	C-1
D	SIMATIC HMI Documentation	D-1

Introduction

Use of the TP 070

The TP 070 has been conceived as a low end unit for the SIMATIC S7-200. It is a touch panel in the SIMATIC HMI product range based on the Microsoft® Windows® CE operating system.

The TP 070 can be used to perform all basic functions. It is equipped with one interface for use with MPI. The unit memory is designed for smaller configurations. The objects used for a configuration can be inputs, outputs, buttons, bar graphs and graphics.

Area of use of the TP 070

The TP 070 has been conceived for machine operation and monitoring. It provides a realistic representation of the machine or system to be monitored. Its area of use includes implementation in machine and apparatus construction as well as in the packing and electronics industry.

The high degree of protection (IP65 on the front side) and non-implementation of moving storage media, such as hard disks and floppy disks, ensure the TP 070 is also suitable for use in rough industrial environments and directly on site on the respective machine.

The TP 070 can be installed in switching cabinets and operating consoles.

Due to the fact that the TP 070 is equipped with high performance basic hardware and has a minimum installation depth means that it fulfills all the requirements for operation in the vicinity of the machine.

Easy to operate and observe

The TP 070 enables operating statuses and current process values concerning a connected PLC to be displayed textually or graphically and the relevant machine or system to be easily monitored and operated. Display and operation of the TP 070 can be adapted optimally for the respective process requirements by using the STEP 7-Micro/WIN 32 (from version 3.1) and STEP 7-Micro/WIN 32 Toolbox (from version 1.0) configuration software.

The TP 070 can be used to:

- control and monitor the process intuitively. Setpoint values or control element settings, for instance, can be modified by entering values or touching configured buttons;
- display processes, machines and systems graphically;
- visualize process tags, e.g. in output fields, status displays or bar graphs;
- intervene directly in the operation by means of the touch-sensitive screen.

Operating unit configuration (principles)

Graphics, texts and operating and display elements which need to be represented on the operating unit must first be created on a configuration computer (PC or PU) using the configuration software. The configuration computer must be connected to the operating unit in order to download the project to the operating unit (refer to “Configuration phase” in figure 1-1).

Once the project has been successfully downloaded, connect the operating unit to the PLC. The operating unit can then communicate with the PLC and respond according to the information configured for running the program in the PLC (refer to “Process control phase” in figure 1-1).

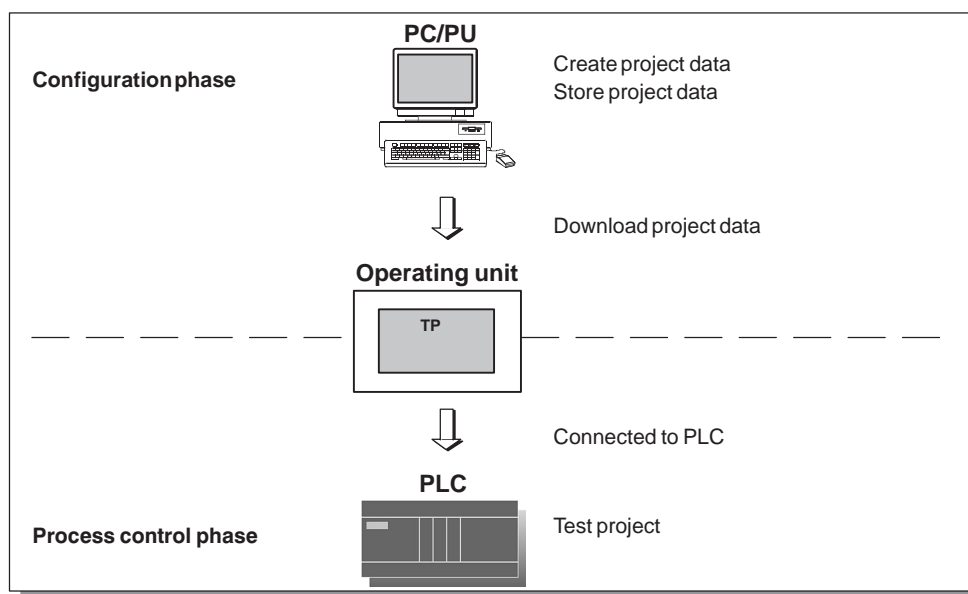
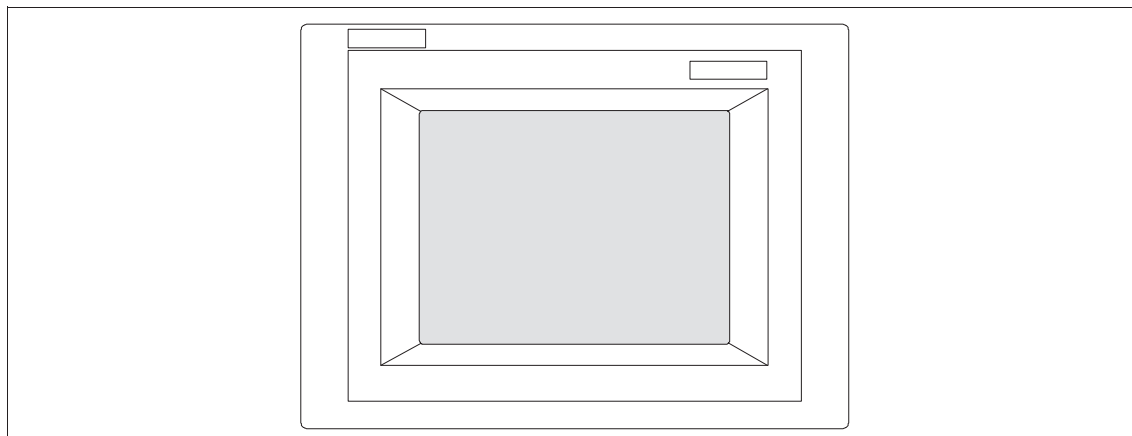

Figure 1-1 Configuration and process control phases

Overview of the TP 070



Overview: Model TP 070

Processor	Type	32 bit RISC
	Clock frequency	66 MHz
Configuration memory	Capacity	128 kB
Software	Operating system	Microsoft® Windows® CE
Interfaces	Serial interface to connect PLC, PC/PU	1 × RS485
Display	Type	STN LCD/Blue mode
	Active screen area (B × H) in mm	116 × 87 (5.7")
	Resolution (pixels)	320 × 240
	Monochrome	4-level
	Back-lighting	CCFL tube
	Half Brightness Life ¹⁾ approx. (h)	50,000

1) Refer to the Glossary for a definition.

Further information

Detailed information on the technical data of the operating unit is provided in appendix A of this manual.

Information concerning configuration of the operating unit is provided in the *Micro/WIN* user guide or *Micro/WIN* online help.

Connection of the operating unit to the PLC is described in chapter 7.

2

Functionality

The table below summarizes the functional scope of the operating unit. The values quoted are the maximum values which can be managed by the operating unit. The values are limited by the size of the memory used.

Function		Comment
Screens	View	✓
	Screen objects	<ul style="list-style-type: none">• Output field• Input field• Text• Graphics• State button• Bar
Screen settings	Contrast	✓
	Touch calibration	✓
Communication	SIMATIC S7-200 <ul style="list-style-type: none">• MPI (to 19.2 kbits/s)	✓

Commissioning

In this chapter

This chapter provides information on:

- starting up the operating unit for the first time (page 3-2)
- restarting the operating unit (page 3-3)
- testing a configuration (page 3-3)

3.1 Initial Startup

Procedure

When the operating unit is started up for the first time, there is no configuration loaded. Proceed as follows, observing the sequence, in order to download a configuration from the configuration computer to the operating unit which is necessary to put the unit into service:

Step	Procedure
1	Connect the operating unit interface IF1B (RS485) to the configuration computer using a PC/PPI cable.
2	Switch on the power supply for the operating unit. Since no configuration has been loaded at this point, the operating unit automatically switches to Download mode. The operating unit displays the message <code>Connecting to host</code> until it receives data from the configuration computer or the button <i>Cancel</i> is pressed.

3.2 Recommissioning

Purpose

Following a restart, the configuration in the operating unit is replaced by a different one. The new configuration is downloaded from the configuration computer to the operating unit.

The following options are available for downloading a configuration:

- Start downloading manually during the operating unit startup phase
- Start downloading via a correspondingly configured operating element while the operating unit is in operation (refer to the chapter 6.1)

Start downloading manually during the operating unit initialization phase

Step	Procedure
1	Connect the operating unit interface IF1B (RS485) to the configuration computer using a PC/PPI cable.
2	Switch on the power supply for the operating unit.
3	During the operating unit start-up phase, a menu appears briefly on the screen. Touch the <i>Download</i> button to set the operating unit to Download mode before it is initialized. The operating unit displays the message <i>Connecting to host</i> until it receives data from the configuration computer or the button <i>Cancel</i> is pressed.

3.3 Test Configuration

Test with connected PLC

When a PLC is connected it is possible to test the communication between the operating unit and PLC. This test also determines whether the correct data areas have been configured.

Check the following configuration elements, for example:

- screen selection,
- input fields.

4

Operating the TP 070

In this chapter

This chapter contains information on how to:

- operate touch elements (from page 4-2)
- enter values (from page 4-4)
- operate screens (page 4-6)

Information regarding operation for special screen objects is provided in chapter 5.

4.1 Operating Touch Elements

Operating concept

The screen is used to observe the operating status of the machine or system being monitored and, at the same time, to intervene directly in the process running simply by touching the buttons and input fields displayed.

Definition

Touch elements are contact-sensitive operating elements provided on the touch panel screen, such as buttons and input fields. Their operation is basically no different from pressing conventional keys. Touch elements are operated by touching them lightly with your finger or a suitable object.

Note

Never use pointed or sharp instruments to operate the Touch Panel to prevent damage to the plastic surface of the touch screen.



Caution

Never touch more than **one** touch panel screen element at a time. If you do, an unintended action may be initiated.

Operation acknowledgement

As soon as the touch panel detects valid contact with a touch element, it responds by displaying a visual acknowledgement. An acknowledgment is independent of communication with the PLC. It is not an indication of the required action actually having been executed.

The type of visual acknowledgement is dependent on the operating element touched:

- **Buttons**

In the case of 3D-effect configurations, visual representation is distinguished according to the statuses *touched* and *untouched*. Examples of representation are illustrated below by means of the Status button.

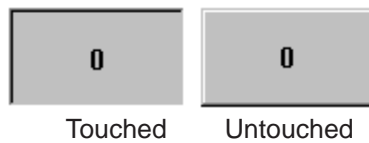

- **Input fields**

After an input field has been touched, the system keyboard illustrated in figure 4-1 appears as the operation acknowledgement.

4.2 Entering Values

Principles of operation

Input fields are used to enter digits (characters 0 to 9 and A to F). To do so, touch the corresponding field. The system keyboard appears.

After completing an entry, the system keyboard automatically disappears. If the entry is valid, the new value is accepted in the input field. If the entry is not valid, the new value is rejected and the old one reset.

System keyboard

The buttons available for operation on the system keyboard are dependent on the type of value to be entered. Buttons which are available for operation are highlighted, and those not available appear simply as empty areas.

Figure 4-1 illustrates an example of the system keyboard for entering decimal values. Table 4-1 explains the significance of each individual button.

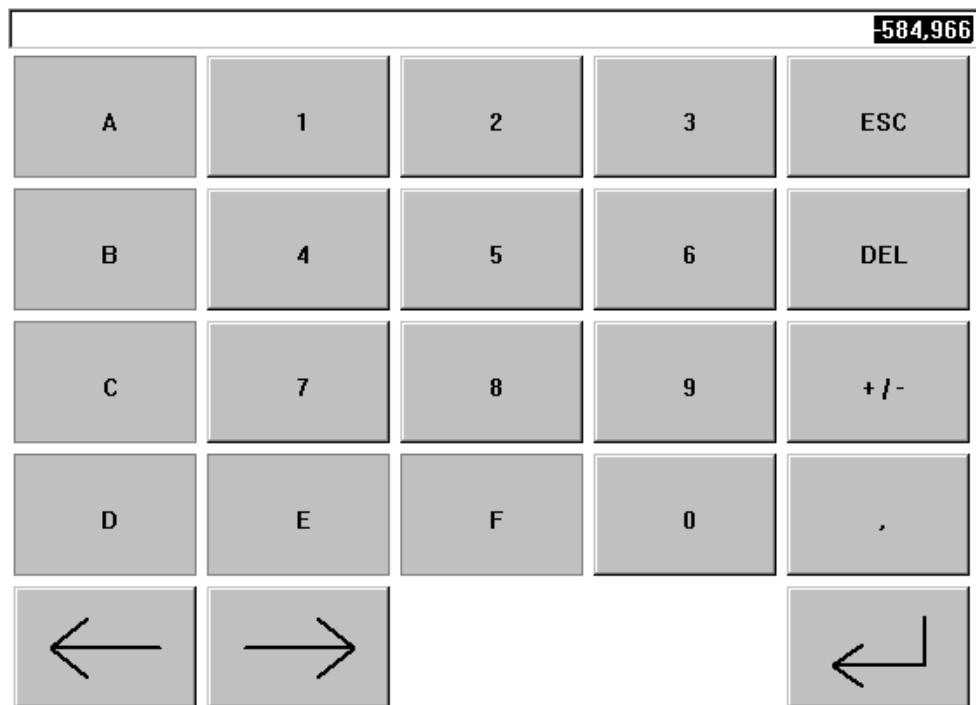











Figure 4-1 System keyboard

Meanings of buttons

Table 4-1 Significance of buttons

Button	Function	Purpose
	Enter digits	Enter digits 0 to 9.
	Enter characters	Enter the characters A to F.
	Change sign	Change sign from + to - and back.
	Enter decimal point	Enter decimal point or comma. The assignment and labeling of this button is language-dependent.
	Move input position to the left	Move current input position one character to the left.
	Move input position to the right	Move current input position one character to the right.
	Cancel (Escape)	Discard input and close the system keyboard.
	Delete character	Delete the character to the left of the input position.
	Enter	Confirm input and close the system keyboard.

Enter value

Characters entered are aligned to the right. On entering a new character, all those already entered are shifted one position to the left (pocket calculator format).

On exceeding the maximum number of characters, the last character entered is overwritten.

4.3 Operating Screens

What is a screen?

Screens visualize the progress of processes and display specified process values. A screen contains logically related process data which the operating unit can both display and modify by operating the individual values.

Screen partitions

A screen is basically composed of static and dynamic sections. The terms “static” and “dynamic” do not refer to the possibility of dynamically positioning screen partitions but to the connection to the PLC.

Static partitions, e.g. text and graphics, are not updated by the PLC. Dynamic partitions, e.g. input and output fields and bars, can be linked to the PLC and display current values constantly read in from the PLC memory. Their connection to the PLC is established by means of tags.

Screen objects

Various screen elements are used to display and operate a screen:

- Output fields
- Input fields
- Texts
- Graphics
- State buttons
- Bar

A summary of all the screen objects which a TP 070 project may contain is provided in chapter 5.

Operation of Screen Objects

In this chapter

This chapter introduces the screen objects which may be contained in a configuration and explains their operation. It provides the following information:

- a summary of screen objects (page 5-2)
- the state button (from page 5-3)

5.1 Overview of Screen Objects

Table 5-1 Screen objects configurable for the TP 070

Screen object	Use/Description
Output field	The output field displays the current value received from the PLC in numeric or alphanumeric form.
Input field	The input field is used to enter values which are then transferred to the PLC. The characters 0..9 and A..F are available for input. Notes on input are provided on page 4-4.
Text	Text is used during configuration to label operating and display elements, for example. Text can be configured over several lines and cannot be altered on the operating unit.
Graphics	Graphics can be used in the configuration, e.g. to represent a system or as an illustrative symbol for configured display and operating elements.
State button	A state button is a display and input element with two different statuses. Notes on the statu buttons is provided on page 5-3.
Bar	Bars represent values from the PLC as rectangular areas. The operating unit thus provides a clear indication of how far the current value is from the limit values, or if a setpoint value has been reached, at a glance. Bars are often used to represent fill levels or workpiece numbers. Direction, scaling and labeling the axis can be configured as required.

5.2 State Button

Purpose

The state button is an operating and display element with the two states *ON* and *OFF*. State buttons indicate the status of a unit which cannot be determined from the operating unit (e.g. a motor). At the same time, it is also possible to change the status of the unit concerned on the operating unit.

Configurable properties

The behavior of the state button can be configured:

- Option: *switch*:
The state button reacts as a toggle switch. Each time it is operated, it switches to the other status and remains in that status until the button is pressed again.
In addition to the tags, which represent the current switch status, the configuration software can be used to define text or graphics for the two statuses *ON* and *OFF*.
- Option: *key*:
The state button reacts as a key-in button. When pressed, the state button changes to the status *ON*. It remains in this status as long as the state button is pressed. When released, it automatically switches back to *OFF*.

Event-related initiation

Use the configuration software to assign the state button one or more functions and to define which events result in the respective function being triggered. The events which can be configured are:

- **Status change**
This function is triggered as soon as the status of the state button changes.
- **Press**
This function is triggered as soon as the state button changes to the status *ON*.
- **Release**
This function is triggered as soon as the state button changes to the status *OFF*.

If the status of the state button changes from the type *switch* due to a modification of the configured variables, none of the described events is triggered.

Representation

When the state button is set to *switch*, the configuration software can be used to assign different text or graphics to indicate the status of the button during runtime.

Figure 5-1 illustrates an example of a state button when pressed (left) and not pressed (right).



Figure 5-1 The two statuses relate to the state button when the switch option is set

6

System Settings

In this chapter

This chapter provides information on the following general settings which can be modified on the operating unit online:

- Operating mode (page 6-2)
- Screen contrast and calibration (page 6-3)
- Screen deactivation (page 6-5)

6.1 Setting an Operating Mode

Conditions for changing operating modes

In order to switch between the operating modes described below, the function *Change_mode* must be linked to an operating element in the project.

Operating modes

It is possible to switch between various operating modes on the operating unit:

Offline mode

In this mode there is no logical connection between the operating unit and PLC. The operating unit can be operated, but processes cannot be operated or visualized.

Online mode

When using this mode, processes can be operated and visualized without restriction. There is a logical connection between the operating unit and PLC or the operating unit attempts to establish one.

Online mode is the predefined operating mode each time the operating unit is started up.

Download mode

This operating mode is used to transfer a configuration from the configuration computer to the operating unit.

6.2 Screen Settings

Purpose

In order to be able to optimize reading from the screen according to varying light conditions and viewing angles, the following settings can be modified:

- **Set contrast**
to compensate for varying light conditions.
- **Calibrate screen**
in order to compensate for the parallel axis, which is dependent on the installation position and angle of observation, and any operating errors which may occur as a result.

There are two ways to modify both the contrast and calibration settings:

- during the initialization phase of the operating unit
- during normal operation

Change screen settings in the initialization phase

Step	Action
1	Switch on the power supply for the operating unit.
2	During the initialization phase, the menu illustrated in figure 6-1 appears briefly. Touch the <i>Config</i> button to call in the configuration menu displayed in figure 6-2.
3	Touch the <i>Contrast +</i> and <i>Contrast –</i> buttons to change the contrast setting of the screen. Note: Touch the buttons sufficiently long enough to detect contrast changes.
4	Touch the <i>Calibrate</i> button in order to calibrate the screen. Five calibration crosses appear in succession on the screen. Touch the respective calibration cross currently displayed. 30 second then remain in which to touch the screen at any position. Only then is the calibration accepted. If calibration is not performed correctly, the new values are not accepted.
5	Touch the <i>OK</i> button to close the configuration menu. As a result, the start screen, illustrated in figure 6-1 appears.

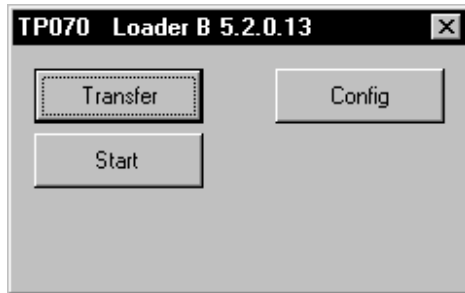

Figure 6-1 TP 070 start menu

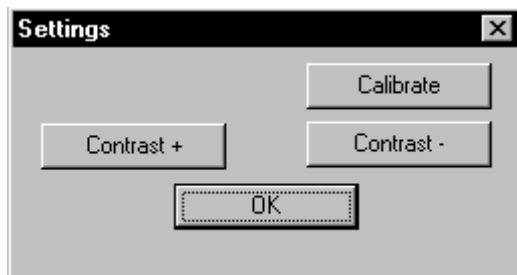

Figure 6-2 Configuration menu

If no configuration is loaded on the operating unit, it switches to download mode automatically after 10 seconds. Touch the *Download* button to switch the operating unit to download mode manually.

If a configuration has already been loaded on the operating unit, it starts it up automatically after 10 seconds. The configuration can be started manually by touching the *Start* button.

Change screen settings during operation

The screen settings can also be changed while the system is actually running. A condition for this is that the following functions are linked to operating elements in the actual project:

- *Change contrast*
- *Touch calibration*

Save settings

The operating unit saves the current screen settings, backed up against a power failure, and sets them automatically when the system is switched on again.

6.3 Deactivate Screen

Purpose

Soiling the TP 070 touch screen cannot be avoided during normal operation. Therefore, the TP 070 should be cleaned at regular intervals. Deactivate the screen prior to cleaning to prevent triggering a function unintentionally.

Conditions for deactivating the screen

In order to deactivate the screen on the operating unit, the function *Clean Screen* must have been assigned to a button in the project.

After touching the relevant button, the screen is cleared and a bar graph appears.

The screen is then deactivated for the time *Deactivation time* defined in the configuration (default setting: 30 seconds). The TP 070 can then be cleaned without any functions being triggered inadvertently. The way to clean the TP 070 is described in chapter 10.

The bar graph on the screen indicates the time remaining until the touch panel is reactivated.

Communication Management for SIMATIC S7

7

In this chapter

This chapter describes the communication between the TP 070 and the SIMATIC S7-200 PLC system.

General information

The connection of the TP 070 to the CPU of the SIMATIC S7-200 concerns a point-to-point connection with the protocol profile DP/T.

Installation

The driver for connecting the SIMATIC S7-200 is supplied with the configuration software and installed automatically.

Connection of the TP 070 to the SIMATIC S7-200 is basically restricted to the physical connection of the operating unit. Special function blocks for connection to the PLC are not required.

7.1 Basic Methods of Functioning

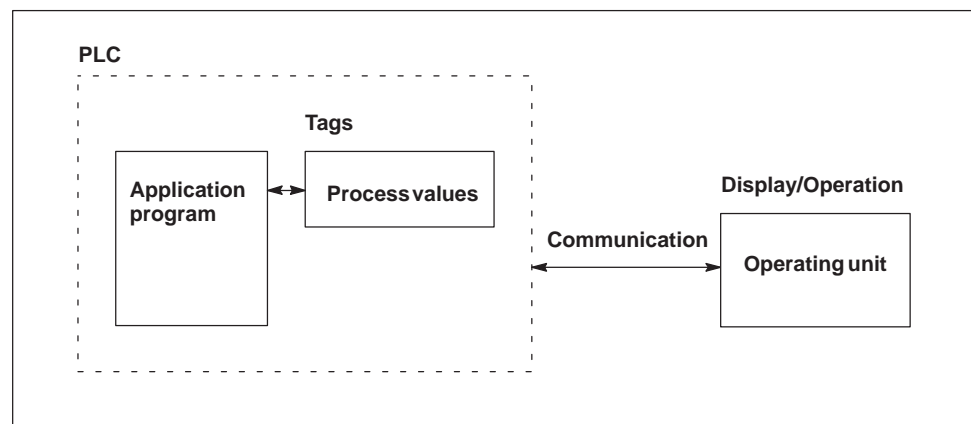

Figure 7-1 Communication structure

Task of the tags

The general exchange of data between the SIMATIC S7-200 and TP 070 is performed via the process values. To do this, tags must be specified in the configuration which point to an address in the S7. The TP 070 reads the value from the specified address and displays it. In the same way, the operator can enter a value on the operating unit, which is then written to the address in the S7.

7.2 Connection to S7-200 via MPI

Configuration

In the case of connection via MPI, the TP 070 is connected to the RS485 interface of the S7-200.

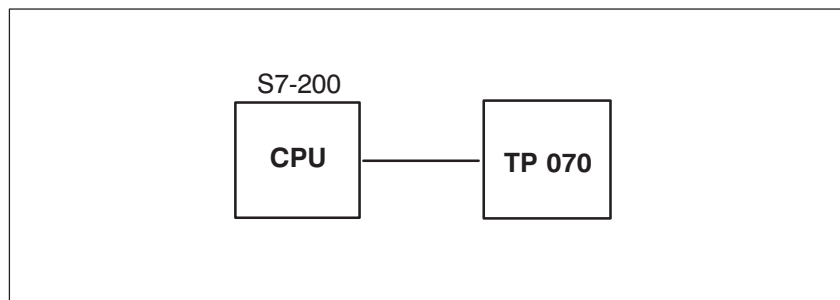

Figure 7-2 Connecting the TP 070 to the SIMATIC S7

Conditions on the TP 070

Observe the following conditions are fulfilled for the connection:

- The PC-PPI cable (used to load the S7 program) must not be used for the connection between the operating unit and S7-200.
- The maximum baud rate is 19.2 kbits/s.

Operating unit configuration

In order that the TP 070 can communicate with a CPU and exchange data, the TP 070 must be correspondingly configured. To do this, the TP 070 address must be defined in the configuration with STEP 7-Micro/WIN and the connections to the communication peer (CPU) configured.

To create a new project, select the menu item *Setup – Communication*, and there the tab *TP → S7-200*. Define the parameters, indicated below.

The individual parameters are explained in table 7-1.

Table 7-1 Network parameter

Network parameter	Explanation
TP address	Address of the TP 070
Protocol	The protocol profile used in the network configuration. Set <i>MPI</i> or <i>DP</i> here.
Baud rate	The baud rate at which communication takes place over the network.
S7-200 address	Address of the S7 module (CPU) to which the TP 070 is connected.
HSA	Highest Station Address; this must be identical throughout the whole network configuration.

Data types supported

The data types listed in table 7-2 are available for the configuration of tags.

Table 7-2 Data types available

Data types supported for S7-200		
Data type	Addressed by	Format
Tag	V	BYTE, INT, WORD, DINT, DWORD, REAL, BOOL, STRING
Input	I	BYTE, INT, WORD, DINT, DWORD, REAL, BOOL, STRING
Output	Q	BYTE, INT, WORD, DINT, DWORD, REAL, BOOL, STRING
Flag	M	BYTE, INT, WORD, DINT, DWORD, REAL, BOOL, STRING
Timer	T	TIMER
Counter	C	COUNTER

7.3 Optimization

Acquisition cycle and update time

The acquisition cycles defined in the configuration software for the tags are major factors in respect of the real update times which can be achieved. The update time is the acquisition cycle plus transmission time plus processing time.

In order to achieve optimum update times, the following points should be observed during configuration:

- Setting acquisition cycles which are too short unnecessarily impairs overall performance. Set the acquisition cycle to correspond to the modification time of the process values. The rate of change of temperature of a furnace, for example, is considerably slower than the acceleration curve of an electric motor.

Guideline value for the acquisition cycle: Approx. 1 second.

- In order that changes on the PLC are reliably detected by the TP 070, they must occur during the actual acquisition cycle at least.

Screens

In the case of screens, the real update time which can be achieved is dependent on the type and quantity of data to be displayed.

In order to achieve rapid update times, only configure short acquisition cycles for those objects actually need to be updated quickly.

Installation

8

In this chapter

This chapter provides information on:

- Installation of the operating unit (from page 8-2)
- Electrical connections to
 - the power supply (page 8-5)
 - the configuration computer (page 8-7)
 - the PLC (page 8-8)

8.1 Mechanical Installation

Installation location and conditions

The operating unit is designed for installation in the front panels of cabinets and consoles. Cut a mounting cut-out in the front panel in preparation for installation of the unit. The thickness of the front panel must not exceed 6 mm. No other holes need to be drilled for mounting.

Details regarding the mounting depth and mounting cut-out are provided on page 9-2.

Degree of protection

The IP65 degree of protection for the front panel can only be ensured when the seal on the front plate of the operating unit is fitted correctly.



Caution

- The unit must be brought to room temperature before it is commissioned. If condensation forms, do not switch the unit on until it is absolutely dry.
 - To prevent the operating unit from overheating during operation,
 - the angle of inclination from vertical installation may not exceed a maximum of $\pm 35^\circ$.
 - do not expose the operating unit to direct sunlight
 - ensure that the ventilation slits in the housing remain free after installation.
 - When the cabinet is opened, certain parts of the system that may conduct hazardous voltage are exposed.
 - The unit was function-tested before shipping. If a fault occurs nevertheless, please enclose a full account of the fault when returning the unit.
-

Installation in front panels

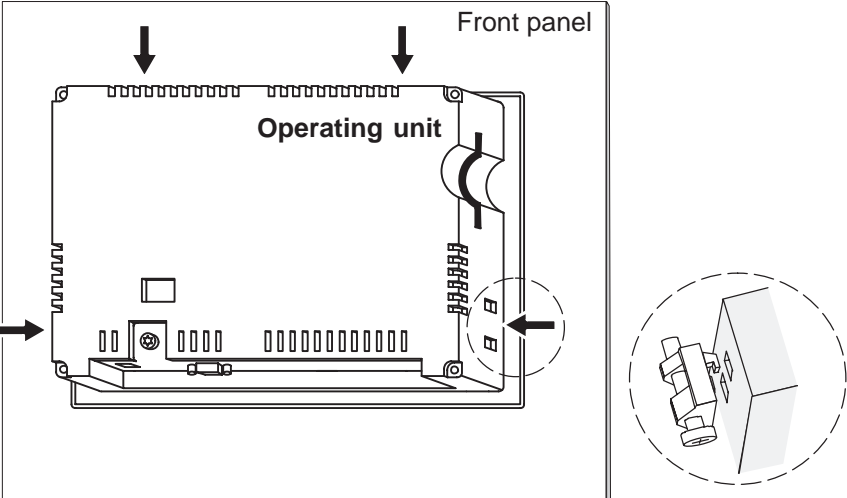
Step	Action
1	Working from the front, insert the operating unit in the mounting cut-out provided. Make sure the unit cannot drop out of the front panel before it has been secured.
2	<p>Insert the hooks of the screw-type clamps enclosed in the corresponding recesses in the housing of the operating unit. The individual positions are indicated in the figure by means of arrows.</p> 
3	<p>Use a screwdriver to tighten the operating unit from the rear in the front panel.</p> <p>Note</p> <ul style="list-style-type: none"> • Make sure the seal is seated correctly against the front panel. • Never apply torques greater than 0.5 Nm in order to prevent damage.

8.2 Electrical Installation

Electrical connections

The operating unit requires electrical connections

- to the power supply,
- to the configuration computer (PU or PC),
- to the PLC.

The electrical connection to the configuration computer is required purely for downloading project data.

EMC compatible installation

A precondition for error-free operation is an EMC compatible hardware design of the PLC and the use of interference-proof cables. The guidelines on interference-free design of the PLCs apply equally to installation of the operating unit.



Caution

- Only shielded cables are permitted for all signal connections.
 - Screw or lock all plug connections.
 - Do not install signal lines in the same cable ducts as power cables.
 - Siemens AG refuses to accept liability for malfunctions and damage arising from use of self-made cables or cables from other manufacturers.
-

Configuration options

Figure 8-1 illustrates a number of configuration options for the operating unit, PLC and configuration computer.

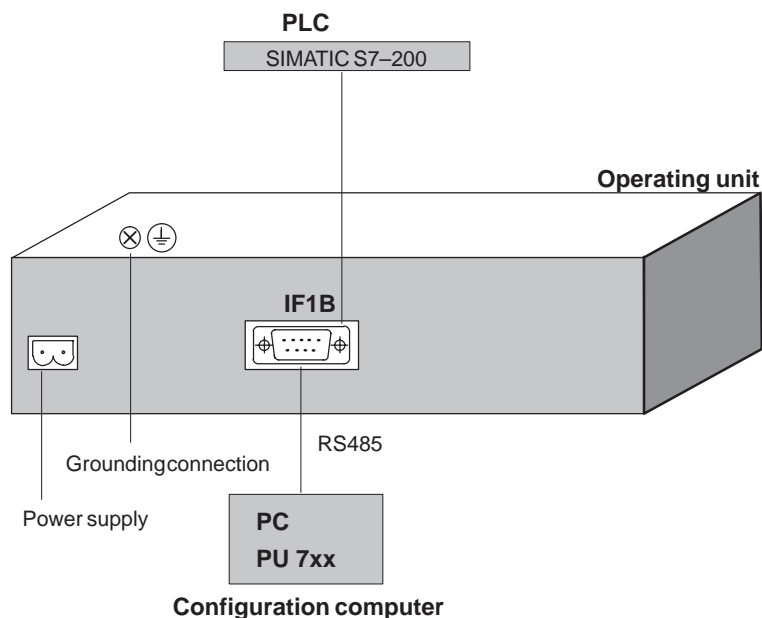

Figure 8-1 Configuration options

Detailed information on connection options is provided in the following pages. Information on the connection plug pin assignment for the interfaces are provided in appendix B of this manual.

Power supply

The power supply for the operating unit is connected at the 2-pin plug connector on the underside of the unit. Use the 2-pin terminal block supplied for this purpose. The terminal block is designed for cables with a cross-section not larger than 2.5 mm².

The figure illustrates a view of the underside of the unit.



Please refer to the technical data in appendix A for information on the power supply requirements.



Caution

- When using a 24 V supply, make sure that the extra-low voltage is isolated safely. Use only power supply units complying with IEC 364-4-41 or HD 384.04.41 (VDE 0100, Part 410).
 - The supply voltage must be within the specified voltage range. Voltages outside this range can cause malfunctions.
-

Grounding connection



Connect the grounding connection of the operating unit to the rack ground. Use the grounding screw provided and a conducting cable with a diameter of $\geq 2.5 \text{ mm}^2$.

8.2.1 Connect configuration computer

Connection configuration

Figure 8-2 illustrates the connection of a configuration computer (PU or PC) to the operating unit to download the project data. The connection displayed is established by means of a PC-PPI cable.

The PC-PPI cable has the following settings:

Switch	Explanation
S1, S2, S3	38,4 kBaud
S4	NC
S5	DCE mode

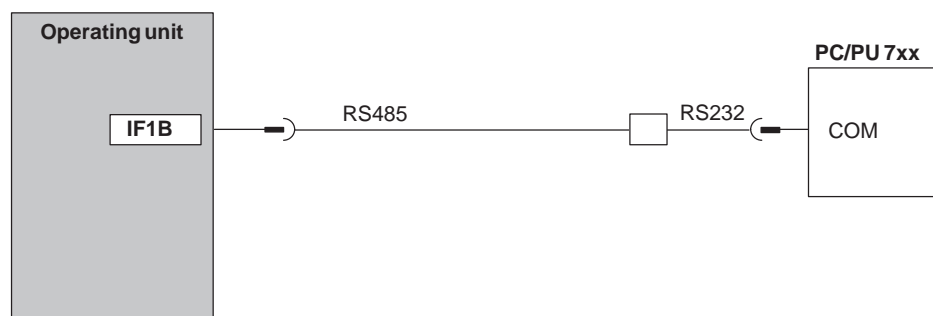
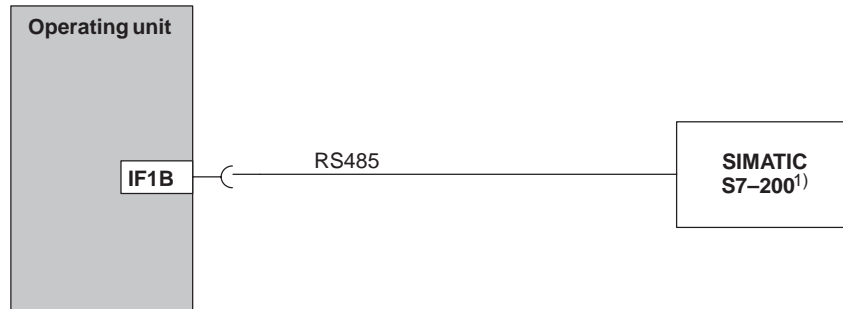

Figure 8-2 Connection configuration diagram for configuration computer

8.2.2 Connect PLC

Connection configuration

Figure 8-3 illustrates the basic connection possibilities between the operating unit and PLC. The connection displayed is established by means of a PC-PPI cable.



1) Only use approved cables for connection to the SIMATIC S7.

Figure 8-3 Connection configuration for PLCs

The following components have been approved for connecting the TP 070 to the SIMATIC S7:

MPI cable	Order no.: 6ES7901-0BF00-0AA0
SINEC L2 bus terminal RS485	Order no.: 6GK15000-0A_006
SINEC L2 bus connector (even)	Order no.: 6GK15000-0EA00
SINEC L2 bus connector (curved)	Order no.: 6ES7972-0B20-0XA0
SINEC L2 FO bus terminal	Order no.: 6GK15000-1A_00

'_' = Length code

Unit Description

In this chapter

This chapter provides information on:

- Dimensions (page 9-2)
- Connection elements (page 9-3)
- Communication options (page 9-4)

9.1 Dimensions

Unit dimensions

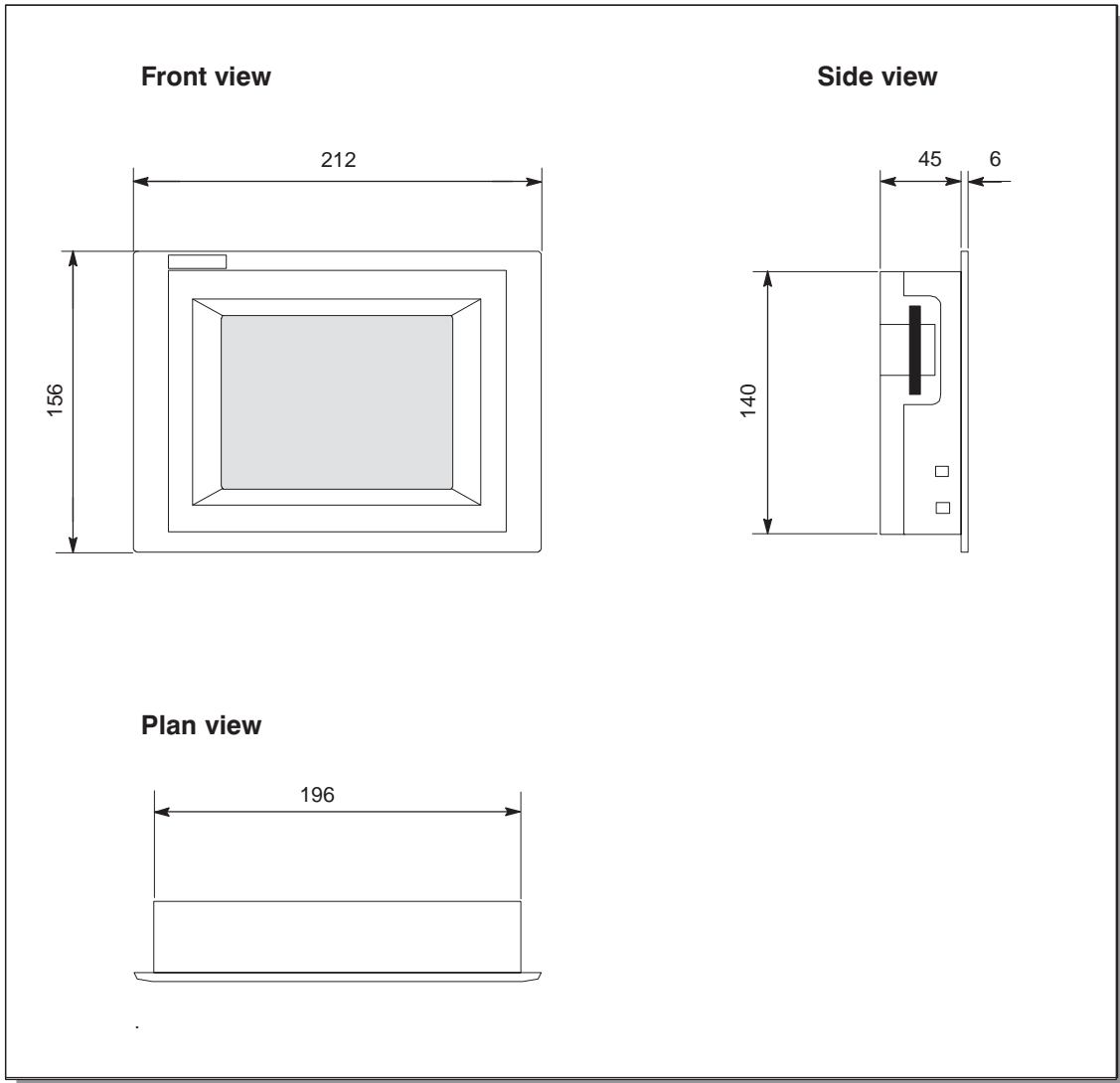

Figure 9-1 TP 070 dimensioning

Mounting cut-out

For installation in the front panel, the operating unit requires a mounting cut-out (WxH) of 198 \pm 1 mm x 142 \pm 1 mm. The thickness of the front panel must not exceed 6 mm.

9.2 Connection Elements

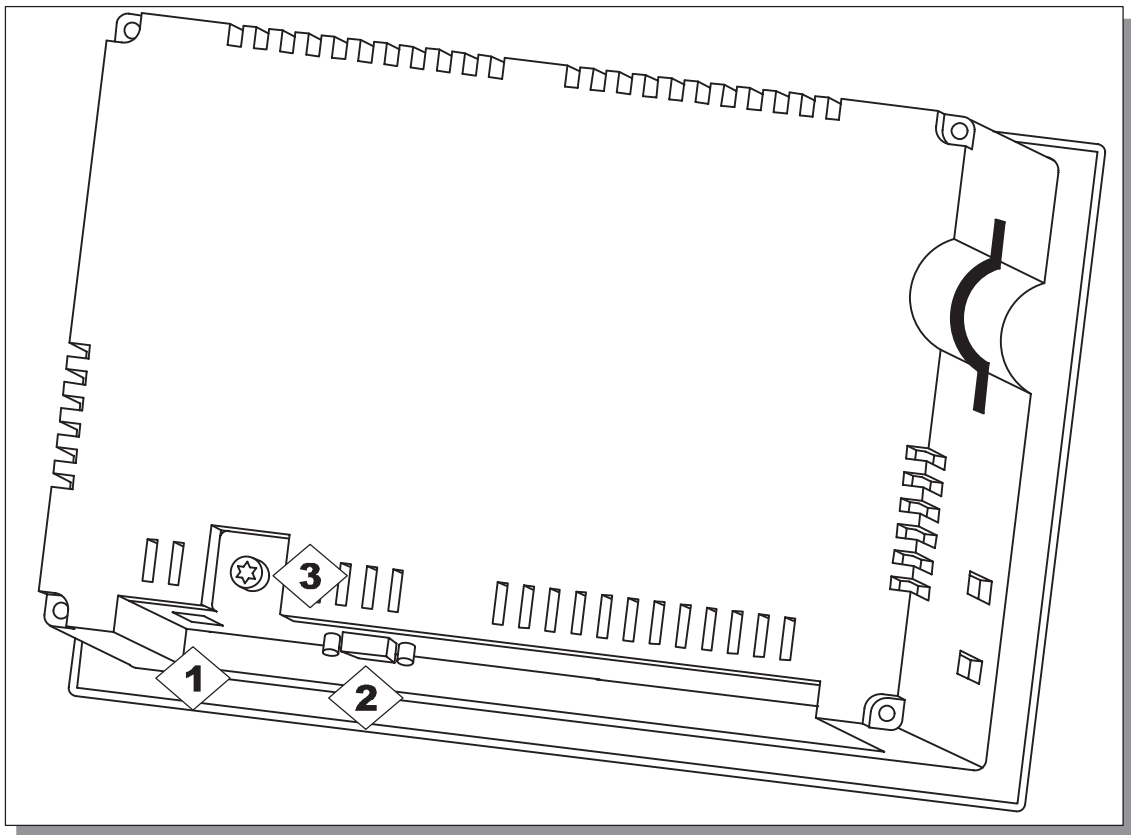

Figure 9-2 Arrangement of connection elements

No.	Name	Description/Use	
2	Interfaces ¹⁾ : • IF1B	Level: RS485	Usage: PLC, PC, PU
3	Grounding connection	For connection to cabinet ground	
1	Power supply ²⁾	Connection for power supply (+24 V DC)	
¹⁾ Connection pin assignment, see appendix B. ²⁾ Connection pin assignment, see page 8-5.			

9.3 Communication Options

Device	Connection	Interface
SIMATIC S7-200	MPI	IF1B
Configuration computer (PC, PU)	RS485	IF1B

Maintenance/Upkeep

10

Cleaning the screen

Clean the operating unit screen at regular intervals using a damp cloth. Before starting, either switch off the unit or deactivate the screen. The way to deactivate the screen is described in chapter 6.3. This ensures that functions are not triggered inadvertently by coming into contact with the screen.

Only use water and washing up liquid or screen cleaning foam to dampen cloths. Never spray the cleaning agent directly onto the screen, but onto the cleaning cloth. Never use aggressive solvents or scouring powder.

Protective foil

A protective foil is available for the operating unit (refer to the ST80 catalog). The foil prevents the screen being scratched and soiled.

Operating System Update

Purpose

It is possible that the downloading of a configuration from the configuration computer to the operating unit is stopped as a result of a compatibility conflict. In this case, there is a conflict between the versions of the configuration software and the operating system on the operating unit.

Please note that on carrying out the procedure described in this chapter, all the data on the operating unit is lost.

Action

Proceed as follows to adapt the operating system on the operating unit to the configuration software:

Step	Action
1	Switch off the power supply for the operating unit.
2	Connect the IF1B (RS485) interface on the operating unit to a serial interface on the configuration computer using a PC-PPI cable.
3	Start the utility program <i>PTUpdate</i> on the configuration computer. This is contained on the configuration software installation CD. It is located in the directory <code>\Images\TP070\Vx_x</code>
4	Select the menu item <i>File</i> → <i>Open</i> and open the image file which corresponds to the operating unit (file extension <code>.img</code>). The image files are located in the same directory as the utility program <i>PTUpdate</i> . The applicable image file can be recognized by its file name, which contains the name of the operating unit. When the image file has been successfully opened, various information appears on the screen related to the versions.
5	Select the menu item <i>File</i> → <i>Settings</i> . Define the interface to be used and the corresponding baud rate for the downloading action.
6	Start the downloading procedure by selecting the menu item <i>File</i> → <i>Download</i> . When the corresponding request appears on the screen, switch the operating unit power supply off.

If the downloading action fails, repeat the process described above.

When downloading is performed successfully, there is no configuration on the operating unit. The behavior of the operating unit without a configuration is described in the chapter 3.1.

APPENDIX

- A Technical Data**
- B Interface Assignment**
- C ESD Guidelines**
- D SIMATIC HMI Documentation**

Technical Data

A

In this appendix

This section of the appendix contains technical data on the TP 070:

- Housing
- Processor
- Memory
- Software
- Display
- Power supply
- Ambient conditions
- Noise immunity / Noise transmission
- Approvals

Housing	
External dimensions (W x H)	212 mm x 156 mm
Mounting cut-out (W x H)	198 ₋₁ mm x 142 ₋₁ mm
Mounting depth	45 mm
Degree of protection complying to EN 60529	
<ul style="list-style-type: none"> • Front panel • Rear panel 	IP65 IP20
Weight	Approx. 0.7 kg

Processor	
Type	32 bit RISC
Clock frequency	66 MHz

Configuration memory	
Capacity	128 kB

Software	
Operating system	MS Windows® CE

Display	
LCD type	STN LCD/Blue mode
Active screen area (B x H) in mm	116 x 87 mm (5.7 ")
Resolution (horizontal x vertical)	320 x 240 pixels
Monochrome	4-level
Back-lighting	CCFL tube
Half Brightness Life ¹⁾	Approx. 50,000 h

1) Definition, refer to glossary

Power supply	
Rated voltage	+ 24 V DC
Permissible voltage range	+18.0...+30.0 V DC
Max. permissible transients	35 V (500 msec)
Time between two transients	50 sec minimum
Power consumption	
<ul style="list-style-type: none"> • Typical • Switch-on current I²t 	Approx. 0.24 A Approx. 0.2 A ² s
Fuse, internal	Electronic



Ambient conditions	
Location Max. permissible angle of inclination without external ventilation	vertical ± 35°
Max. permissible ambient temperature • Operation – Vertical installation – Installation angled from the perpendicular to max. 35° • Shipping, storage	STN display 0...+50 °C 0...+40 °C –20...+60 °C
Relative humidity Operation Shipping, storage	20...85%, no condensation 5...90%, no condensation
Shock loading Operation Shipping, storage	15 g/11 msec 25 g/6 msec
Vibration Operation Shipping, storage	0.035 mm (10 – 58 Hz) 1 g (58 – 500 Hz) 3.5 mm (5 – 8,5 Hz) 1 g (8.5 – 500 Hz)
Barometric pressure Operation Shipping, storage	706 to 1030 hPa 581 to 1030 hPa

Compliance of the named products with the regulations of Directive 89/336 EEC is verified by conformance with the following standards:

Noise immunity	
Static discharge (contact discharge/air discharge)	EN 61000-4-2 6 kV/8 kV
RF irradiation	EN 61000-4-3 10 V/m, 80% AM, 1 kHz
Pulse modulation	ENV 50204 900 MHz \pm 5 MHz 10 V/m _{eff.} , 50% ED, 200 Hz
RF conduction	EN 61000-4-6 150 kHz – 80 MHz 10 V, 80% AM, 1 kHz
Burst interference Supply lines Process data lines Signal lines	EN 61000-4-4 2 kV 2 kV 1 kV

Radio interference	
Radio interference level complying to EN 55011	Class A

The following approvals have been applied for or already granted on supply. Please refer to the rating plate on the rear of the unit for identification.

Approvals	
UL approval	UL Recognition Mark ²⁾ Underwriters Laboratories (UL) complying with Standard UL 508, File E 120869
cUL approval	In accordance with the UL/CSA Approval Agreement
FM Approval	complying to Factory Mutual Approval Standard Class Number 3611 Hazardous (classified) Locations Class I, Division 2, Group A, B, C, D
	 <p>Warning: Personal injury and equipment damage can occur. Personal injury and equipment damage can occur in hazardous areas if a plug connection is disconnected from the operating unit while the system is running. In hazardous areas, always switch off the power supply to the operating unit before disconnecting plugs.</p>
	 <p>Warning: DO NOT DISCONNECT WHILE CIRCUIT IS LIVE UNLESS LOCATION IS KNOWN TO BE NON-HAZARDOUS.</p>

2) The file number of the UL approval is dependent on the production site. The number specified here changes according to the production site.

B

Interface Assignment

IF1B

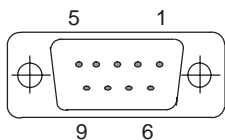

Table B-1 Pin assignment of the 9-pin Sub-D socket

Pin	RS485
1	-
2	GND
3	LTG-B
4	-
5	GND
6	+5 V
7	+24 V Output
8	LTG-A
9	-

ESD Guidelines

What does ESD mean?

Virtually all present-day modules incorporate highly integrated MOS devices or components. For technological reasons, these electronic components are very sensitive to overvoltages and consequently therefore to electrostatic discharge:

These devices are referred to in German as Elektrostatisch Gefährdeten Baulemente/ Baugruppen: "EGB"

The more frequent international name is:

"ESD" (Electrostatic Sensitive Device)

The following symbol on plates on cabinets, mounting racks or packages draws attention to the use of electrostatic sensitive devices and thus to the contact sensitivity of the assemblies concerned:



ESDs may be destroyed by voltages and energies well below the perception threshold of persons. Voltages of this kind occur as soon as a device or an assembly is touched by a person who is not electrostatically discharged . Devices exposed to such overvoltages cannot immediately be detected as defective in the majority of cases since faulty behavior may occur only after a long period of operation.

Precautions against electrostatic discharge

Most plastics are capable of carrying high charges and it is therefore imperative that they be kept away from sensitive components.

When handling electrostatic sensitive devices, make sure that persons, workplaces and packages are properly grounded.

Handling ESD assemblies

A general rule is that assemblies should be touched only when this cannot be avoided owing to the work that has to be performed on them. Under no circumstances should you handle printed-circuit boards by touching device pins or circuitry.

You should touch devices only if

- you are grounded by permanently wearing an ESD wrist strap or
- you are wearing ESD shoes or ESD shoe-grounding protection straps in conjunction with an ESD floor.

Before you touch an electronic assembly, your body must be discharged. The simplest way of doing this is to touch a conductive, grounded object immediately beforehand – for example, bare metal parts of a cabinet, water pipe etc.

Assemblies should not be brought into contact with charge-susceptible and highly insulating materials such as plastic films, insulating table tops and items of clothing etc. containing synthetic fibers.

Assemblies should be deposited only on conductive surfaces (tables with an ESD coating, conductive ESD cellular material, ESD bags, ESD shipping containers).

Do not place assemblies near visual display units, monitors or television sets (minimum distance to screen > 10 cm).

Measuring and modifying ESD assemblies

Perform measurements on ESD assemblies only when

- the measuring instrument is grounded – for example, by means of a protective conductor – or
- the measuring head has been briefly discharged before measurements are made with a potential-free measuring instrument – for example, by touching a bare metal control cabinet.

When soldering, use only grounded soldering irons.

Shipping ESD assemblies

Always store and ship assemblies and devices in conductive packing – for example, metallized plastic boxes and tin cans.

If packing is not conductive, assemblies must be conductively wrapped before they are packed. You can use, for example, conductive foam rubber, ESD bags, domestic aluminum foil or paper (never use plastic bags or foils).

With assemblies containing fitted batteries, make sure that the conductive packing does not come into contact with or short-circuit battery connectors. If necessary, cover the connectors beforehand with insulating tape or insulating material.

SIMATIC HMI Documentation

D

Target groups

This manual is part of the SIMATIC HMI documentation. The documentation is aimed at the following target groups:

- Newcomers
- Users
- Configurers
- Programmers
- Commissioning engineers

How the documentation is organized

The SIMATIC HMI documentation consists of the following components:

- User's Guides for:
 - Configuration software
 - Runtime software
 - Communication between PLCs and operating units
- Equipment Manuals for the following operating units:
 - SIMATIC PC
 - MP (Multi Panel)
 - OP (Operator Panel)
 - TP (Touch Panel)
 - TD (Text Display)
 - PP (Push Button Panel)
- Online Help on the configuration software
- Start-up Guides
- First Steps

Overview of complete documentation

The following table provides an overview of the SIMATIC HMI documentation and shows you when you require the different documents.

Documentation	Target Group	Content
First Steps with ProTool Product Brief	Newcomers	<p>This documentation guides you step by step through the configuration of</p> <ul style="list-style-type: none"> • a screen with various objects • changing from one screen to another • a message. <p>This documentation is available for:</p> <ul style="list-style-type: none"> • OP 3, OP 5, OP 7, OP 15, OP 17 • OP 25, OP 27, OP 35, OP 37, TP 27, TP 37 • Windows-based systems
ProTool Configuring Windows-based Systems User's Guide	Configurers	<p>Provides information on working with the ProTool/Pro configuration software. It contains</p> <ul style="list-style-type: none"> • information on installation • basic principles of configuration • a detailed description of configurable objects and functions. <p>This documentation is valid for Windows-based systems.</p>
ProTool Configuring Graphics Displays User's Guide	Configurers	<p>Provides information on working with the ProTool configuration software. It contains</p> <ul style="list-style-type: none"> • information on installation • basic principles of configuration • a detailed description of configurable objects and functions. <p>This documentation is valid for graphic display operating units.</p>
ProTool Configuring Text-based Displays User's Guide	Configurers	<p>Provides information on working with the ProTool/Lite configuration software. It contains</p> <ul style="list-style-type: none"> • information on installation • basic principles of configuration • a detailed description of configurable objects and functions. <p>This documentation is valid for text-based display operating units.</p>
ProTool Online Help	Configurers	<p>Provides information on the configuration computer while working with ProTool. Online Help contains</p> <ul style="list-style-type: none"> • context-sensitive help • detailed instructions and examples • detailed information • all the information from the user guide.
ProTool/Pro Runtime User's Guide	Commissioning engineers, Users	<p>Provides information on working with ProTool/Pro Runtime software. It contains</p> <ul style="list-style-type: none"> • installation of the ProTool/Pro Runtime visualization software • commissioning and running the software on Windows-based systems.

Documentation	Target Group	Content
Copy Protection Start-up Guide	Commissioning engineers, Users	The ProTool/Pro Runtime visualization software is a copyright product. This manual contains information on the installation, repair and uninstallation of authorizations.
Application Example Start-up Guide	Newcomers	ProTool is supplied with example configurations and the corresponding PLC programs. This documentation describes how you <ul style="list-style-type: none"> • load the examples onto the operating unit and PLC • run the examples and • upgrade the connection to the PLC to suit your own specific application.
SIMATIC Panel PC 670 Equipment Manual	Commissioning engineers, Users	Describes the computer unit and operating unit of the SIMATIC Panel PC 670.
MP 270 Equipment Manual TP 170A Equipment Manual TP 070 Equipment Manual	Commissioning engineers, Users	Describes the hardware and the general operation of Windows-based Panels: <ul style="list-style-type: none"> • installation and commissioning instructions • a description of the equipment • operating instructions • instructions for connecting the PLC, printer and programming computer, • maintenance instructions.
OP 37/Pro Equipment Manual	Commissioning engineers, Users	Describes the hardware, installation and inclusion of upgrades and options for the OP 37/Pro.
TP 27, TP 37 Equipment Manual OP 27, OP 37 Equipment Manual OP 25, OP 35, OP 45 Equipment Manual OP 7, OP 17 Equipment Manual OP 5, OP 15 Equipment Manual TD 17 Equipment Manual	Commissioning engineers, Users	Describes the hardware and general operation. It contains <ul style="list-style-type: none"> • installation and commissioning instructions • a description of the equipment • instructions for connecting the PLC, printer and programming computer, • operating modes • operating instructions • description of the standard screens supplied with the operating unit and how to use them • fitting options • maintenance and fitting of spare parts.
OP 3 Equipment Manual	Commissioning engineers, Users, Programmers	Describes the hardware of the OP3, its general operation and the connection to the SIMATIC S7.
PP 7, PP 17 Equipment Manual	Commissioning engineers, Users	Describes the hardware, installation and commissioning of push-button panels PP 7 and PP 17.

Documentation	Target Group	Content
Communication User's Guide	Programmers	<p>Provides information on connecting text-based and graphics displays to the following PLCs:</p> <ul style="list-style-type: none"> • SIMATIC S5 • SIMATIC S7 • SIMATIC 500/505 • drivers for other PLCs <p>This documentation describes the</p> <ul style="list-style-type: none"> • configuration and parameters required for connecting the devices to the PLC and the network • user data areas used for exchanging data between operating unit and PLC.
Communication for Windows-based Systems User's Guide	Programmers	<p>Provides information on connecting Windows-based systems to the following PLCs:</p> <ul style="list-style-type: none"> • SIMATIC S5 • SIMATIC S7 • SIMATIC 505 • OPC • Allen Bradley PLC-5/SLC 500 • Mitsubishi FX • Telemecanique TSX <p>This documentation describes the</p> <ul style="list-style-type: none"> • configuration and parameters required for connecting the devices to the PLC and the network • user data areas used for exchanging data between operating unit and PLC.
Other PLCs Online Help	Programmers	<p>Provides information on connecting devices to PLCs, such as:</p> <ul style="list-style-type: none"> • OPC • Mitsubishi • Allen Bradley • Telemecanique • Modicon • Omron • SIMATIC WinAC <p>When the drives are installed, the relevant Online Help is installed at the same time.</p>
ProAgent for OP User's Guide	Configurers	<p>Provides the following information about the ProAgent optional package (process diagnosis) for OPs</p> <ul style="list-style-type: none"> • configuring system-specific process diagnosis • detecting, locating the cause of and eliminating process errors, • customizing standard diagnostic screens supplied with the software.

Glossary



Bar graphs

Represent values from the **PLC** as rectangular areas. This is a way of displaying filling levels or workpiece numbers, for example, on the operating unit.

Baud rate

Rate of speed at which data is downloaded. Baud rate is specified in Bit/s.

Boot

A loading process which downloads the operating system in the working memory of the operating unit.



Configuration

Definition of system-specific default settings and screens using the configuration software **STEP 7-Micro/WIN**.



Download

The transfer of run-capable project data to the operating unit.

Download mode

Operating unit operating mode in which data can be downloaded from the configuration computer to the operating unit (also refer to **Download**).



Flash memory

Programmable memory which can be electrically deleted and written to again segment-by-segment.



Half Brightness Life

The period of time after which the brightness tube only achieves 50% of the original value.



Input field

Enables the user to enter values which are subsequently downloaded to the **PLC**.



Multi panel

Multi-functional, configurable operating unit with graphics display and Windows® CE operating system for operating and monitoring machines and systems.



Normal operation

Operating unit operating mode in which messages are displayed and screens can be operated.

**Output field**

Displays current values from the **PLC** on the operating unit.

**PLC**

General term for units and systems with which the operating unit communicates (e.g. SIMATIC S7 or PC).

Process screen

The display of process values and process progress on the operating unit in the form of screens, which may contain graphics, texts and values.

Programmable system

PLC from the SIMATIC S7 series (SIMATIC S7-200/300/400).

**RS485**

Standard interface for serial data transfer at a very high transmission rate.

**Screen**

A screen displays all the logically related process data on the operating unit, whereby the individual values can be modified.

Start screen

The first screen, which automatically appears after the operating unit has started up.

State button

The state button is a configurable display and operating element which can have one of two states: **ON** and **OFF**, i.e. **touched** and **untouched**. Text or graphics can be configured for both states which then appear on the state button.



Tag

A defined memory location in which values can be read from and written to. This can be performed from the **PLC** or via the operating unit. Depending on whether the tag is linked to the PLC or not, a distinction is made between “global” tags (process tags) and “local” tags.

Touch panel

This is an operating unit without a keyboard. The touch panel (abbreviated to TP) is operated via the contact-sensitive screen elements.

Index

A

Acknowledgement, on touching, 4-3
 Acquisition cycle, SIMATIC S7, 7-6
 Address
 Operating unit, 7-4
 SIMATIC S7, 7-4
 Air discharge, A-4
 Ambient conditions, A-3
 Angle of inclination, 8-2, A-3
 Approvals, A-5
 Area of use, 1-1
 Arrangement, connection elements, 9-3
 Assignment of interfaces, B-1

B

Back-lighting, screen, 1-3, A-2
 Bar graph, 5-2
 Barometric pressure, A-3
 Baud rate, SIMATIC S7, 7-4
 Burst interference, A-4

C

Cable, PC-PPI, 8-7
 Cable cross-section, 8-5
 Cables, 8-4
 Calibration screen, 6-3
 Change contrast, Function, 6-4
 Change_mode, Function, 6-2
 Character, delete, 4-5
 Character alignment, 4-5
 Characters, enter, 4-5
 Clean Screen, function, 6-5
 Cleaning
 Screen, 6-5
 Unit, 10-1
 Cleaning agents, 10-1
 Clock frequency, 1-3, A-2
 Commissioning, 3-1
 Communication, 2-1
 Communication management,
 SIMATIC S7, 7-1
 Communication options, 9-4

Communication structure, SIMATIC S7, 7-2
 Communication via tags, SIMATIC S7, 7-2
 Compatibility conflict, 11-1
 Condensation, 8-2
 Conditions on the TP 070, SIMATIC S7-200,
 7-3
 Conduction, RF, A-4
 Configuration, test, 3-3
 Configuration, load, 3-2
 Configuration computer, 1-2, 8-5
 Connect, 8-7
 Configuration menu, 6-3
 Configuration options, 8-5
 Configuration phase, 1-2
 Configuration software, 1-2
 Conflict, compatibility, 11-1
 Connect
 Configuration computer, 8-7
 PLC, 8-8
 Connecting, Power supply, 8-5
 Connection
 To configuration computer, 8-7
 To PLC, 6-2, 8-8
 Connection elements, 9-3
 Connection via MPI, SIMATIC S7, 7-3
 Connections, electrical, 8-4
 Connector pin-out, B-1
 Contact discharge, A-4
 Contrast, 2-1
 Set, 6-3
 Cross-section, power supply, 8-5
 Cut-out, installation, A-2

D

Data, Technical, A-1
 Data types, SIMATIC S7, 7-5
 Decimal point, entering, 4-5
 Degree of protection, 1-1, 8-2, A-2
 DEL, 4-5
 Depth, installation, A-2
 Description, unit, 9-1
 Digits, enter, 4-5
 Dimensions, 9-2, A-2
 Discharge, static, A-4

Display, 1-3, A-2
 Set contrast, 6-3
Download, operating mode, 6-2
Download mode, 3-3
Dynamic screen partitions, 4-6

E

Electrical connections, 8-4
Electrical Installation, 8-4
EMC-compatible installation, 8-4
ENTER, 4-5
Entering, values, 4-4
ESC, 4-5
ESD Guidelines, D-1
Events, 5-3
External dimensions, A-2

F

Fixation, 8-3
FM Approval, A-5
Front panel, Thickness, 8-2, 9-2
Front view, TP 070, 9-2
Functionality, 2-1
Functions
 Change contrast, 6-4
 Change_mode, 6-2
 Clean screen, 6-5
 Touch calibration, 6-4
Fuse, A-3

G

General operation, 4-1
Graphic, 5-2
Grounding, 8-6
Grounding connection, 8-5, 8-6, 9-3
Grounding screw, 8-6
Guidelines
 EEC, A-4
 ESD, D-1

H

Half Brightness Life, 1-3
Hazardous area, A-5
Hexadecimal digits, enter, 4-5
Housing, A-2
HSA, SIMATIC S7, 7-4
Humidity, A-3

I

IF1B interface, assignment, B-1
Initial startup, 3-2
Input
 Cancel, 4-5
 Confirm, 4-5
Input field, 5-2
Input field, 4-4
Installation, 8-1
 Configuration computer, 8-7
 Electrical, 8-4
 In front panels, 8-3
 Mechanical, 8-2
 PLC, 8-8
 SIMATIC S7, 7-1
Installation conditions, 8-2
Installation location, 1-1, 8-2
Interface, 9-3
 IF1B, 8-7, 8-8
Interface Assignment, B-1
Interfaces, 1-3
Interference-free, 8-4
Introduction, 1-1
Irradiation, RF, A-4
Isolation, electrical, 8-6

K

Key, Status button, 5-3

L

LCD type, A-2
Load, configuration, 3-2
Location, A-3
Low-voltage, 8-6

M

Maintenance, 10-1
Manual downloading, 3-3
Mechanical installation, 8-2
Memory, Configuration, 1-3, A-2
Message category, C-2
Message number, C-1
Micro/Win, 1-2
Model, overview, 1-3
Monochrome, 1-3, A-2
Mounting cut-out, 8-3, 9-2, A-2
Mounting depth, A-2
Move input position, right, 4-5

Move input position, left, 4-5
 MPI, 2-1
 MPI connection, SIMATIC S7, 7-3

N

Network configuration, SIMATIC S7, 7-1, 7-3
 Noise immunity, A-4
 Numeric keypad
 Changing sign, 4-5
 Entering decimal point, 4-5

O

Off state, Status button, 5-3
 Offline, operating mode, 6-2
 Online, operating mode, 6-2
 Operating
 Screens, 4-6
 Touch elements, 4-2
 Operating concept, 4-2
 Operating mode
 Download, 6-2
 Offline, 6-2
 Online, 6-2
 Setting, 6-2
 Operating screens, 4-6
 Operating system, A-2
 Operating system update, 11-1
 Operating unit configuration, SIMATIC S7, 7-4
 Operation, general, 4-1
 Operation, screen objects, 5-1
 Operation acknowledgement, 4-3
 Optimization
 Contrast, 6-3
 SIMATIC S7, 7-6
 Output field, 5-2
 Overheating, 8-2

P

PC, 1-2
 Connection, 8-7
 PC-PPI cable, 8-7, 11-1
 Performance, SIMATIC S7, 7-6
 Pin array, 8-5
 Pin assignment, B-1
 Plan view, TP 070, 9-2
 PLC, 8-5
 Connect, 8-8
 Plug connections, 8-4

pocket calculator format, 4-5
 Power cables, 8-4
 Power consumption, A-2
 Power supply, 8-5, 9-3, A-2
 Power supply unit, 8-6
 Principles, entering Values, 4-4
 Print, event, 5-3
 Process control phase, 1-2
 Processor type, 1-3, A-2
 Protective foil, 10-1
 Protocol, SIMATIC S7, 7-4
 PUpdate, utility program, 11-1
 PU, 1-2
 Connection, 8-7
 Pulse modulation, A-4

R

Radio interference, A-4
 Radio interference level, A-4
 Rated voltage, A-2
 Recommissioning, 3-3
 Relative humidity, A-3
 Release, event, 5-3
 Resolution, display, 1-3, A-2
 RF conduction, A-4
 RF irradiation, A-4

S

Screen, A-2
 Cleaning, 6-5
 Screen, Set contrast, 6-3
 Screen area, display, 1-3, A-2
 Screen calibration, perform, 6-3
 Screen objects, 4-6
 operating, 5-1
 Overview, 5-2
 Screen optimization, SIMATIC S7, 7-6
 Screen partitions, 4-6
 Screen settings, 2-1
 Screw-type clamp, 8-3
 Seal, 8-2, 8-3
 Serial zero modem cable, 11-1
 Settings
 Calibration of the screen, 6-3
 Contrast, 6-3
 Deactivate screen, 6-5
 Operating mode, 6-2
 System, 6-1
 Shock loading, A-3

Side view, TP 070, 9-2
Sign, changing, 4-5
Signal lines, 8-4
SIMATIC S7, 2-1
Software, 1-3, A-5
Standards, A-4
Start downloading manually, 3-3
Static discharge, A-4
Static screen partitions, 4-6
Status button, 5-2, 5-3
Status change, event, 5-3
Sub-D socket, B-1
Sunlight, 8-2
Switch, Status button, 5-3
System keyboard, 4-4
System messages, List, C-1
System settings, 6-1

T

Tags, SIMATIC S7, 7-2
Technical data, A-1
Terminal block, 8-5
Test, configuration, 3-3
Text, static, 5-2
Thickness, front panel, 8-2, 9-2
Torque, 8-3

Touch calibration, 2-1
 Function, 6-4
Touch element
 Definition, 4-2
 Operation, 4-2
Transients, A-2

U

UL approval, A-5
Unit description, 9-1
Unit dimensions, 9-2
Update, operating system, 11-1
Update time, SIMATIC S7, 7-6
Upkeep, 10-1
Utility program, PTUpdate, 11-1

V

Ventilation slits, 8-2
Vibration, A-3
Visual acknowledgement, 4-3

W

Weight, A-2
Windows CE, 1-1, A-2