

simatic PCS 7



SIMATIC PCS 7
Process Control System

SIEMENS

Related catalogs

SIMATIC ST PCS 7.1
Add-ons for the SIMATIC PCS 7
Process Control System

Only PDF:
(E86060-K4678-A121-A6-7600)



Training for Automation and Industrial Solutions ITC

Order no.:
E86060-K6850-E101-B8 (in German)



SIMATIC ST PCS 7.2
Migration solutions with the
SIMATIC PCS 7
Process Control System

Order no.:
E86060-K4678-A131-A3-7600



Catalog CA 01
the Offline Mall of
Automation and Drives

Order no.:
E86060-D4001-A100-C6 (CD-ROM)
E86060-D4001-A500-C6 (DVD)



SIMATIC ST 70
Products for Totally Integrated
Automation and Micro Automation

Order no.:
E86060-K4670-A101-B1-7600
E86060-K4670-A151-A3-7600 (News)



A&D Mall

Internet:
www.siemens.com/automation/mall



SIMATIC HMI ST 80
Human Machine Interface
Systems

Order no.:
E86060-K4680-A101-B5-7600



Industrial Communication IK PI
Industrial Communication for
Automation and Drives

Order no.:
E86060-K6710-A101-B5-7600
E86060-K6710-A121-A2-7600 (News)



TELEPERM M PLT 112
AS 488/TM
Automation Systems

Only PDF:
(E86060-W3812-A100-A3-7600)



**Field Instruments
for Process Automation** FI 01

Order no.:
E86060-K6201-A101-A9-7600



SIMATIC PCS 7 Process Control System Version 7.0

Catalog ST PCS 7 ·
October 2007

Supersedes:
Catalog ST PCS 7 · March 2007

The products contained in this catalog
can also be found in the e-Catalog CA 01
Order No.:
E86060-D4001-A110-C6-7600 (CD-ROM)
E86060-D4001-A510-C6-7600 (DVD)

Please contact
your local
Siemens branch

© Siemens AG 2007



The products and systems described in this catalog are manufactured/distributed under application of a certified quality management system in accordance with DIN EN ISO 9001 (Certified Registration No. 1323-QM). The certificate is recognized by all IQNet countries.



SIEMENS

Introduction	1
System-neutral components	2
Starter systems	3
Engineering system	4
Operator system	5
Batch automation	6
SIMATIC Route Control	7
Asset Management	8
Communication	9
Automation systems	10
Process I/O	11
IT world	12
Migration to SIMATIC PCS 7	13
Ordering data for previous version SIMATIC PCS 7 V6.1	14
Update/upgrade packages	15
Appendix	16

Siemens Automation and Drives. Welcome

More than 70,000 people aiming for the same goal: increasing your competitiveness. That's Siemens Automation and Drives.

We offer you a comprehensive portfolio for sustained success in your sector, whether you're talking automation engineering, drives or electrical installation systems. Totally Integrated Automation (TIA) and Totally Integrated Power (TIP) form the core of our offering. TIA and TIP are the basis of our integrated range of products and systems for the manufacturing and process industries as well as building automation. This portfolio is rounded off by innovative services over the entire life cycle of your plants.

Learn for yourself the potential our products and systems offer. And discover how you can permanently increase your productivity with us.

Your regional Siemens contact can provide more information. He or she will be glad to help.



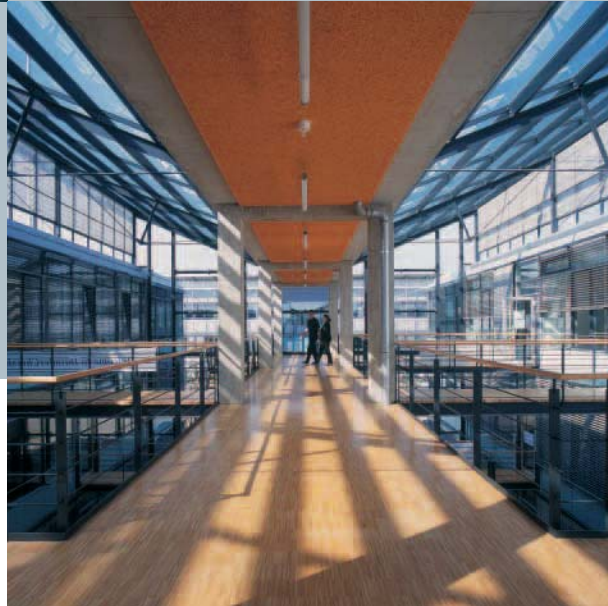
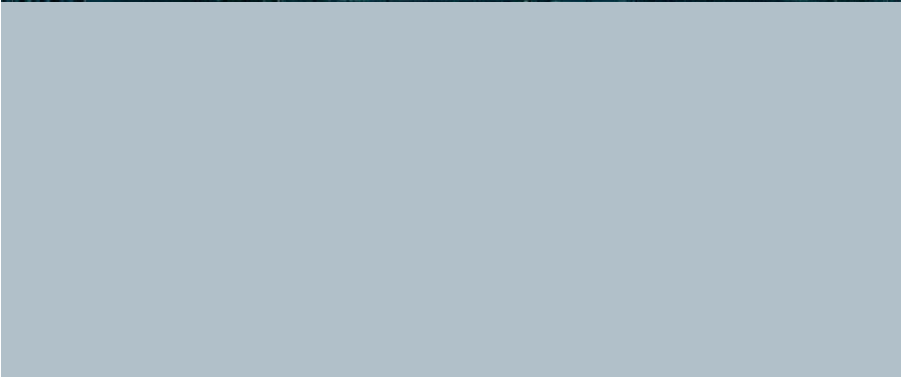

Sharpen your competitive edge. Totally Integrated Automation

With Totally Integrated Automation (TIA), Siemens is the only manufacturer to offer an integrated range of products and systems for automation in all sectors - from incoming goods to outgoing goods, from the field level through the production control level to connection with the corporate management level.

On the basis of TIA, we implement solutions that are perfectly tailored to your specific requirements and are characterized by a unique level of integration. This integration not only ensures significant reductions in interface costs but also guarantees the highest level of transparency across all levels.

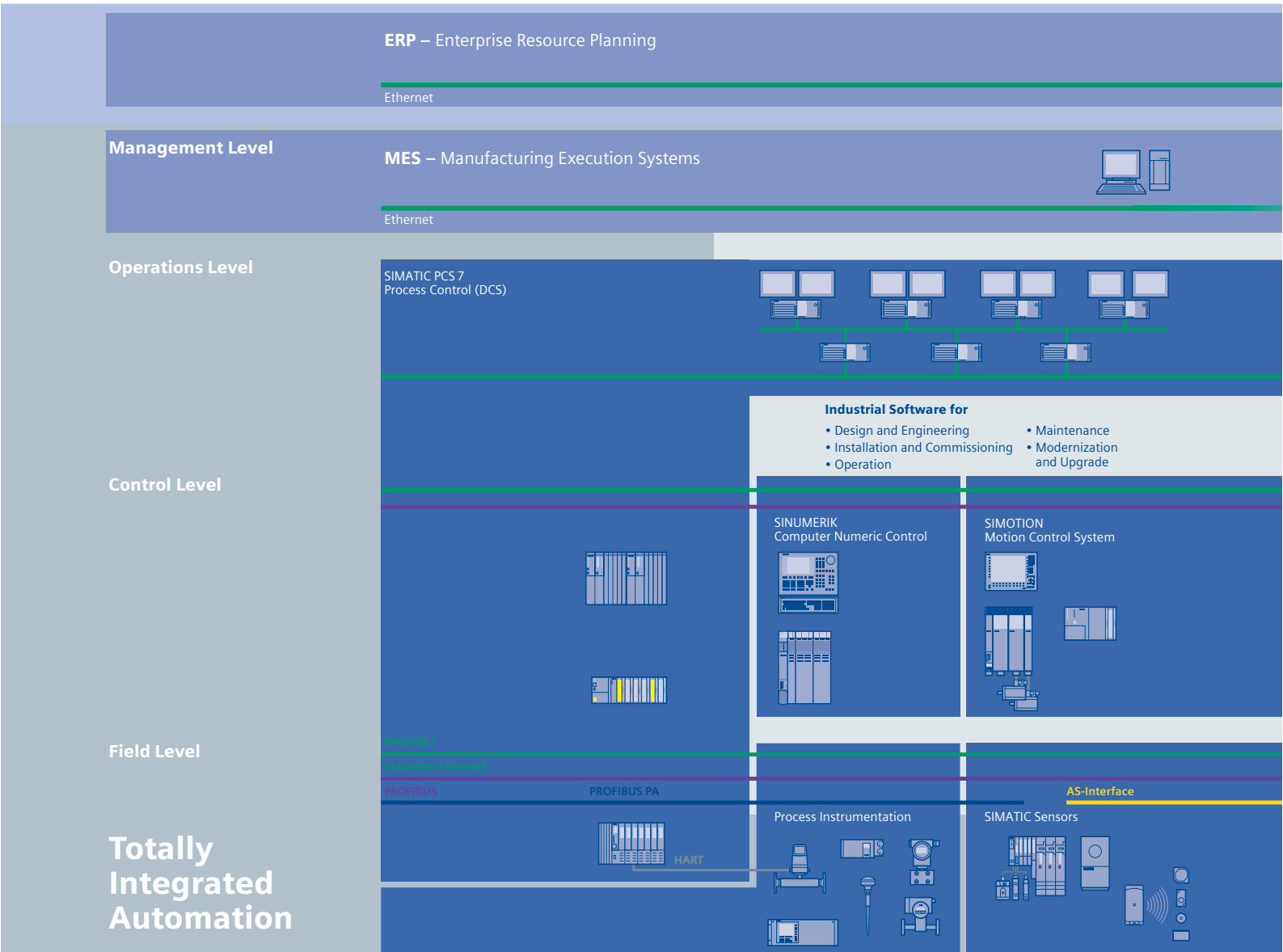

It goes without saying that you profit from Totally Integrated Automation during the entire life cycle of your plants - from the first planning steps, through operation, right up to modernization. Consistent integration in the further development of our products and systems guarantees a high degree of investment security here.

Totally Integrated Automation makes a crucial contribution towards optimizing everything that happens in the plant and thus creates the conditions for a significant increase in productivity.

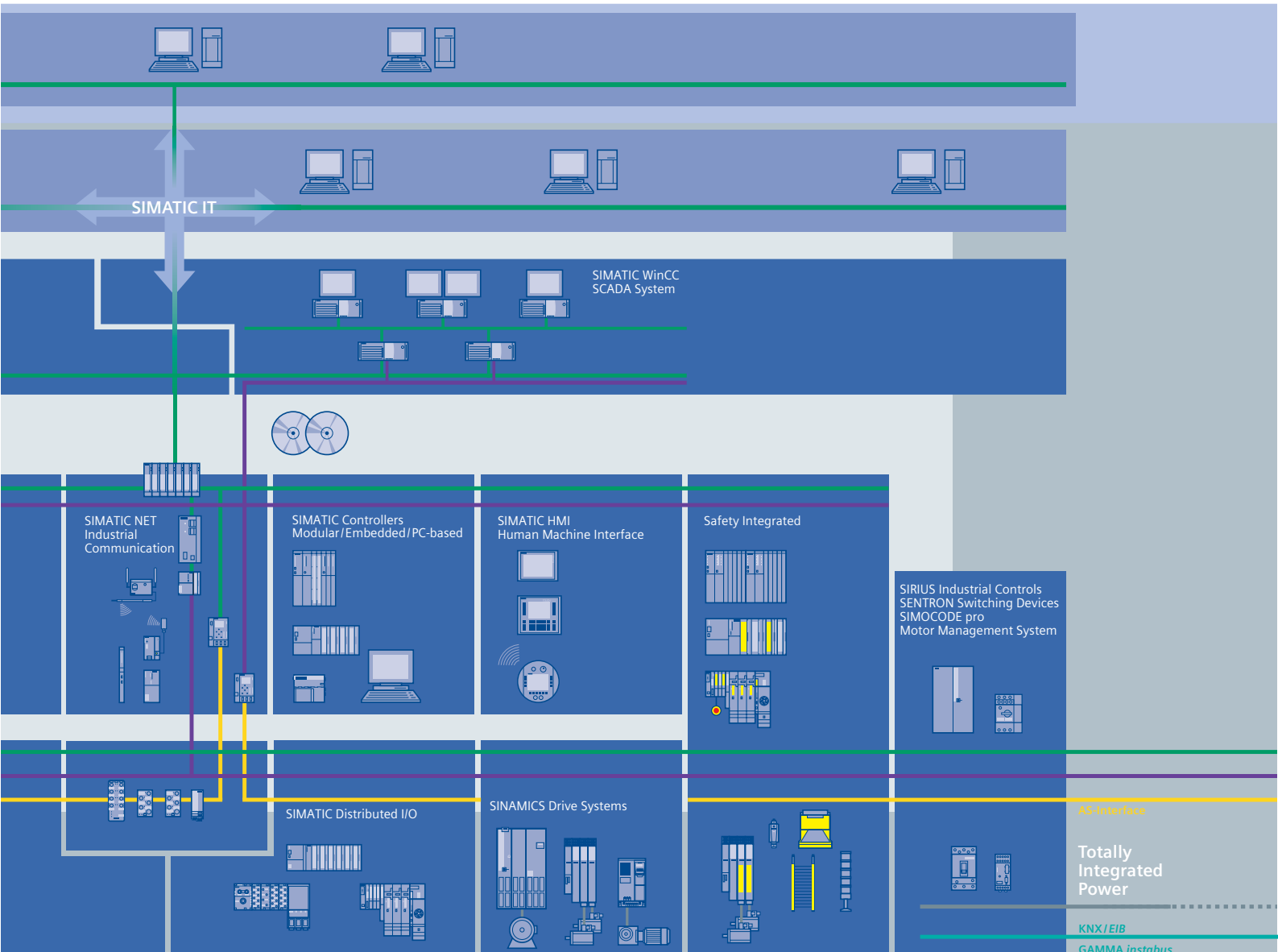

Integrated energy distribution from a single source. Totally Integrated Power

Totally Integrated Power (TIP) brings together all the components of electrical energy distribution into an integrated whole. Thus TIP provides the answer to growing market demands in the planning, construction and use of utility buildings and industrial buildings.

On the basis of TIP, we offer integrated solutions for energy distribution, from medium voltage to the power outlet. Totally Integrated Power is based here on integration in planning and configuring as well as on perfectly matched products and systems.

Communication

Process/production automation

HMI

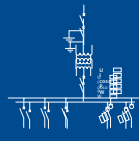

Load management

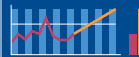

Graphs



Prognoses



PROFI
BUS

Products and systems



≤ 110 kV

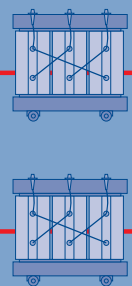

Planning and configuration

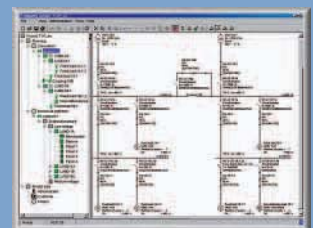

Protecting the environment and resources. Environmental sustainability

Environmental protection will continue to grow in importance as a result of progressive urbanization and global population growth. These global mega-trends make the careful and sustainable handling of natural resources a central challenge.

We are convinced that every individual - and especially every company - has an ecological responsibility. At Siemens Automation and Drives, we stand by this conviction. Our high environmental protection goals are part of our strict environmental management. We investigate the possible effects of our products and systems on the environment right back at the development stage. We concern ourselves, for example, with the question of how to reduce power consumption in plant operation - and we offer appropriate solutions, such as our energy-saving motors that cut power consumption in industrial manufacturing by up to 40% thanks to their high efficiency levels.

Our products and systems comply with the EC Directive RoHS (Restriction of Hazardous Substances). All the relevant Siemens AG sites are, of course, certified in accordance with DIN EN ISO 14001.

Our commitment goes well beyond compliance with the relevant directives and legislation: we are an active driving force behind environmental protection, through further development of environmental management systems, for example, and we are involved in professional associations such as the German Electrical and Electronic Manufacturers Association (ZVEI).



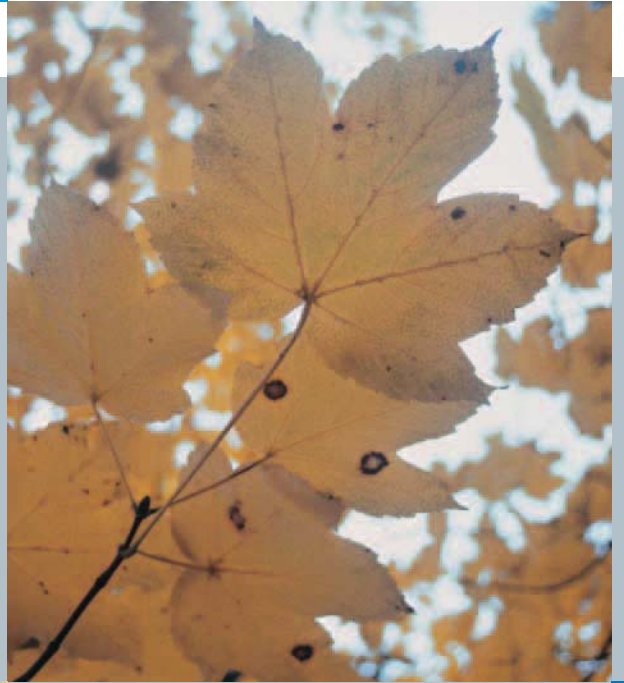

Introduction

System architecture

SIMATIC PCS 7 V7.0

Overview

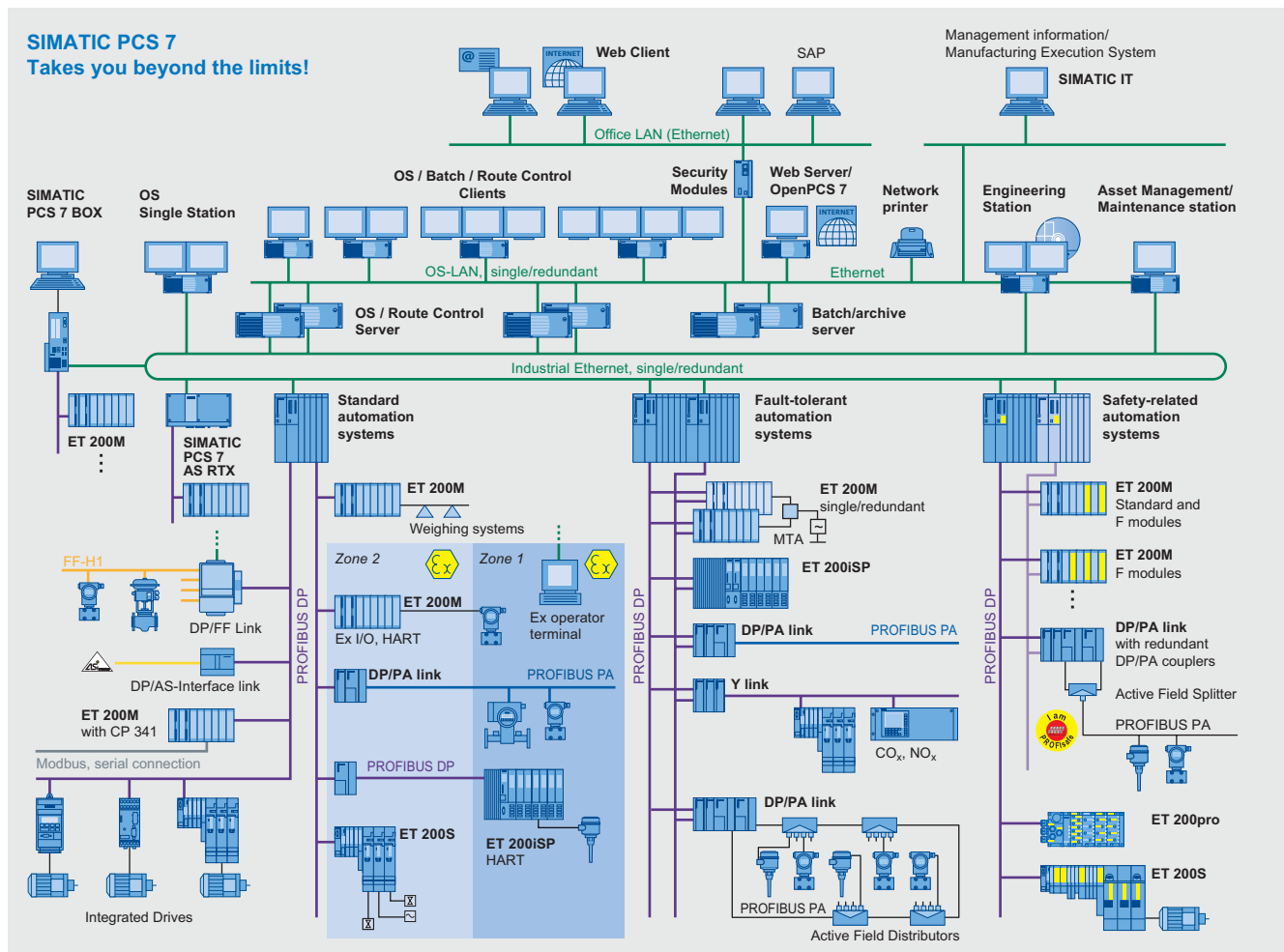

SIMATIC PCS 7 system configuration

Totally Integrated Automation with SIMATIC PCS 7

The SIMATIC PCS 7 process control system is a significant component of Totally Integrated Automation (TIA), the unique basis offered by Siemens for uniform and customized automation in all sectors of the production, process and hybrid industries. Using TIA, Siemens is the only company able to offer uniform automation technology on one single platform for all applications of process automation, starting with input logistics, covering production or primary processes as well as downstream (secondary) processes, up to output logistics. This is suitable for optimization of all operating sequences of an entire company, i.e. from the ERP (Enterprise Resource Planning) level and MES (Management Execution System) level to the control level, right down to the field level.

Integrated in a holistic automation solution for a production site, automation of the primary processes is the prime task of SIMATIC PCS 7. On the other hand, secondary processes (e.g. filling, packaging) or input/output logistics (e.g. raw material distribution, storage) are frequently implemented using the PLC-based or PC-based components of SIMATIC.

The advantages of Totally Integrated Automation, in particular the uniform data management, communication and configuration, are already evident during planning and engineering, but also during installation and commissioning, everyday operation as well as maintenance, repairs and modernization.

Uniform data management means that all software components access a common database. Within a project, inputs and modifications are therefore only necessary at one point. This reduces the work required, and simultaneously avoids potential faults. Once symbolic identifications have been introduced, they are understood by every software component. Data consistency is also guaranteed even if several persons are working simultaneously on a project. Parameters defined in the engineering system can be transferred beyond the network limits down to sensors, actuators or drives in the field.

Uniform communication from the corporate management level down to the field level is based on internationally recognized standards such as Industrial Ethernet or PROFIBUS, and also supports the global flow of information via the Internet. Since the hardware and software components involved also use these communications mechanisms, connections are extremely easy to configure, also cross-system or over different networks.

The use of an engineering system with a uniform and matched range of tools minimizes the configuration overhead. The engineering tools for the application software, the hardware components and the communications functions can be called from a central project manager (SIMATIC Manager). This is also the basic application for creation, management, saving and documentation of a project.

Compatibility of further developments is guaranteed within TIA. This also guarantees that the company's investments have a secure future, and allows the company to modernize and expand the plants throughout the complete lifecycle.

Benefits

With its pioneering design, modular and open architecture based on state-of-the-art SIMATIC technology, consistent application of industrial standards, and the I&C functionality paired with high-performance, the SIMATIC PCS 7 process control system allows cost-effective implementation and economical operation of I&C plants in all phases of their lifecycle and with consideration of all aspects: from planning, engineering, commissioning, training, through operation, maintenance and repair, up to expansion and refurbishment. In the process, SIMATIC PCS 7 combines high-performance and reliability with simple and safe operation and maximum convenience.

You primarily profit from Totally Integrated Automation with the SIMATIC PCS 7 process control system through:

- Calculable development, implementation and lifecycle costs
- Minimization of engineering overhead
- Facilities for process optimization
- Adaptability to changing requirements
- Advantages resulting from the use of standard SIMATIC components, such as:
 - Low hardware and engineering costs
 - Proven quality and stability
 - Simple, fast definition and selection of system components
 - Low costs for spare parts
 - Short delivery times for spare parts and expansion components
 - Global availability
 - Savings in logistics, maintenance and training costs

Function

A consistent and homogeneous overall system

SIMATIC PCS 7 is a modern process control system that can be used alone or in combination with other systems, e.g. SIMATIC, SIMOTION or drive systems, as a consistent and homogenous overall system. Its popularity is increasing along with the demand for seamlessly integrated universal automation engineering solutions, which is determined by sustained competition and price pressure, the demand for increasingly flexible production plants and the need for increased productivity.

Against the background of ever-increasing complexity, in particular due to the merging of automation engineering with information technology, horizontal and vertical integrated system platforms are being increasingly accepted in comparison to automation solutions with so-called "best-in-class products".

Totally Integrated Automation with SIMATIC PCS 7 combines consistent data management, communication and configuration with outstanding system properties and high performance. This guarantees that the typical demands placed on a process control system are comprehensively satisfied, and that you are perfectly equipped for future requirements:

- Simple and reliable process control
- User-friendly operation and visualization, also using the Internet
- Powerful, fast and consistent system-wide engineering
- System-wide online modifications
- System openness at all levels
- Flexibility and scalability
- Redundancy at all levels
- Safety-related automation solutions
- Extensive fieldbus integration
- Flexible solutions for batch processes

- Efficient control of material transport
- Asset management for I&C equipment (diagnostics, preventive maintenance and repairs)
- Direct interface with the IT world
- Advanced security concept for safeguarding the I&C system.

Flexibility and scalability

As a result of its modular architecture based on selected hardware and software components from the standard SIMATIC range, SIMATIC PCS 7 can be applied effectively in small and large plants alike. It allows easy expansion or system modification to enable customers to meet the changing production requirements of their facility. SIMATIC PCS 7 is scalable from a small single system consisting of approx. 160 process tags (motors, valves, PID controllers), such as might be used for a laboratory system or a test center, up to a distributed multi-user system with client/server architecture and approx. 60,000 process tags, such as might be used for automation of a very large production plant or for groups of connected facilities.

SIMATIC PCS 7 thus covers all sizes of plant - and if the plant grows, SIMATIC PCS 7 grows with it!

Open for the future

SIMATIC PCS 7 is based on modular hardware and software components, which are perfectly matched to one another due to their conformance with TIA. These components can be expanded and innovated seamlessly and with little effort and are open for the future via long-term stable interfaces. This makes long-term protection of customer investments possible, despite the fast pace of innovation and short product cycles.

SIMATIC PCS 7 consistently applies new, powerful technologies together with internationally established industrial standards such as IEC, XML, PROFIBUS, Ethernet Gigabit technology, TCP/IP, OPC, ISA-88 or ISA-95, just to mention a few.

Openness with SIMATIC PCS 7 covers all levels, and equally applies to automation systems and process I/Os as to industrial communications networks, operator systems or engineering systems.

Not just system architecture and communication are characterized by openness. This is a feature also evident in the programming and data transfer interfaces for user programs as well as in the import and export functions for graphics, text and data, e.g. from the CAD/CAE world. SIMATIC PCS 7 can therefore also be combined with components from other vendors, and integrated in existing infrastructures.

Introduction



System-neutral components



2/2	System documentation
2/4	Administration
2/6	Operating system
2/7	SIMATIC PCS 7 Industrial Workstation
2/7	Introduction
2/10	Basic hardware
2/16	Multi-VGA graphics cards
2/17	Operator panels/monitors
2/18	Special configurations



System-neutral components

2

System documentation

Overview

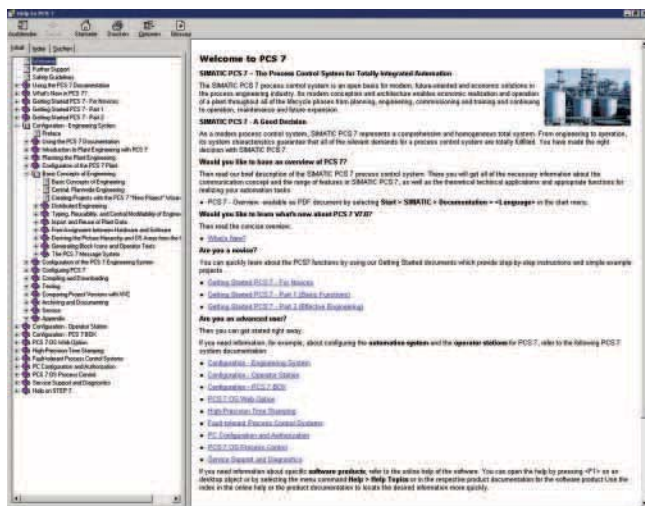

The system documentation of the SIMATIC PCS 7 process control system is an integral component of the SIMATIC PCS 7 system software. It is available in two versions:

- As online help (HTML help)
- As electronic documentation in Acrobat Reader format (PDF)

The 3-language documentation (German, English, French) provides both beginners and experienced users with valuable information on all aspects of the process control system. The range extends from the system introduction, covers initial steps and cross-system topics, up to a description of individual system components. With the "Getting Started" documentation you can gain initial practical experience using example projects.

SIMATIC PCS 7 Programming Instructions Driver Blocks

Programming Instructions for creating drive blocks and with the title "SIMATIC PCS 7 Programming Instructions Driver Blocks" can be ordered separately. These Programming Instructions help the advanced SIMATIC PCS 7 user to create system-conform driver blocks, which can be placed like standard blocks on system plans and automatically parameterized and interconnected in HW-Config.

S7 Manual Collection

As a supplement to the SIMATIC PCS 7 system documentation, the S7 Manual Collection provides comprehensive information on all system components offered in the context of SIMATIC S7. This multi-language collection of electronic manuals on DVD contains documentation on the following in addition to the SIMATIC PCS 7 system documentation:

- SIMATIC S7-200/300/400,
- SIMATIC C7,
- LOGO! logic module,
- SIMATIC DP,
- SIMATIC PC,
- SIMATIC programming devices,
- STEP 7,
- engineering software,
- runtime software,
- SIMATIC PCS 7,
- SIMATIC HMI and
- SIMATIC NET.

The electronic manuals of the S7 Manual Collection are usually in 5 languages (German, English, French, Italian, Spanish), those of the integral SIMATIC PCS 7 system documentation mostly in 3 languages (German, English, French).

For the migration of existing plants, you may also require detailed information on the system components of TELEPERM M or SIMATIC S5.

TELEPERM M Manual Collection

The TELEPERM M Manual Collection comprises TELEPERM M manuals in 2 languages (German, English) on CD.

S5 Manual Collection

An S5 Manual Collection in 2 languages (German, English) on CD, which contains all electronic manuals concerning SIMATIC S5, rounds off the range of available information.

Selection and Ordering Data	Order No
SIMATIC PCS 7 Programming Instructions Driver Blocks V7.0 for SIMATIC PCS 7 V6.1 and V7.0 Electronic documentation on CD, in 2 languages (German, English) Type of delivery: CD, certificate of license, terms and conditions	6ES7 653-1XD07-8YX8
SIMATIC S7 manuals	
S7 Manual Collection Electronic manuals on DVD, in 5 languages (German, English, French, Italian, Spanish)	6ES7 998-8XC01-8YE0 D)
S7 Manual Collection - maintenance service for 1 year Type of delivery: Current DVD "S7 Manual Collection" and the three subsequent updates	6ES7 998-8XC01-8YE2 D)
TELEPERM M migration manuals	
TELEPERM M Manual Collection Electronic manuals on CD, in 2 languages (German, English)	6DL5 900-8AX03-8YX8 D)
SIMATIC S5 manuals	
S5 Manual Collection Electronic manuals on CD, in 2 languages (German, English)	6ES5 998-7WE02 D)

D) Subject to export regulations: AL: N, ECCN: 5D992B1

More information



The "SIMATIC Guide Manuals" on the Internet directs you straight to the complete range of technical documentation available for SIMATIC products and systems in German, English, French, Italian, Spanish and Chinese. If other languages are available, you can also find them there. You can select individual documents from this range for viewing or downloading.

Additional information is available in the Internet under:



<http://www.siemens.com/simatic-docu>

System-neutral components

2

Administration

Overview

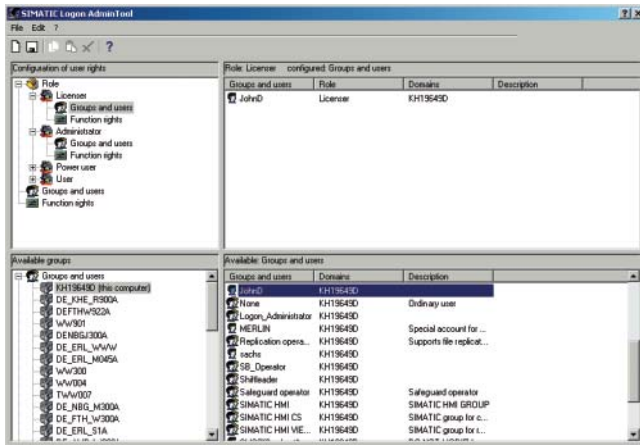

Central user management, access control and electronic signature

SIMATIC Logon is a central user administration function with access control based on Windows 2000/XP and Windows Server 2003 for:

- System components of SIMATIC PCS 7
- Non-system components linked via an interface

It can be used to fulfill the validation requirements of 21 CFR Part 11. An electronic signature function can also be used in conjunction with SIMATIC Logon.

SIMATIC Logon Upgrade

All previous versions can be upgraded to the current version.

Design

The optional chipcard reader can be used for access control in addition to the keyboard. SIMATIC Logon additionally supports logon devices which can be operated with a Microsoft device driver for the respective operating system (e.g. logon devices on a USB interface). It is also possible to connect logon devices via a separately created device-specific drive.

The number of SIMATIC Logon licenses required depends on the number of clients/single stations that access applications for which SIMATIC Logon is used for access protection.

SIMATIC Logon was developed for the SIMATIC PCS 7 process control system but can also be used together with other SIMATIC products in the context of Totally Integrated Automation (TIA), e.g. with SIMATIC WinCC. A requirement for working together is that user groups have already been created in the partner applications, or can be defined.

SIMATIC Logon is already integrated in the system software of the SIMATIC PCS 7 V7.0 process control system. Separate licenses are not required in this context.

Function

SIMATIC Logon Admin Tool

Using the SIMATIC Logon Admin Tool it is possible to assign the roles defined in the SIMATIC PCS 7 applications (e.g. Automation License Manager and SIMATIC BATCH) to the Windows users/user groups. Administrators with the necessary Windows administrator privileges can also use the SIMATIC Logon Admin Tool to edit Windows users and user groups.

SIMATIC Logon Service

The login dialog of the SIMATIC Logon Service is activated when an application is started which is managed by SIMATIC Logon. The user receives his specific privileges after making the login, password and domain entries. The SIMATIC Logon Service dialog for logoff, user change or password edit can be called in the applications.

SIMATIC Electronic Signature

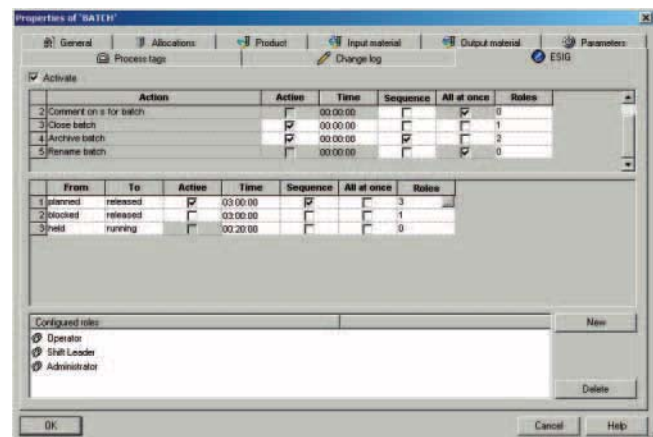

The SIMATIC Electronic Signature means that operations cannot be performed until enabled by previously assigned Windows users/user groups. Users/user groups are assigned to the operations in the respective application.

At the moment this function is implemented as a system function only on SIMATIC BATCH. However, the Electronic Signature can be used on any products in the specific applications.

The software products listed here under "Selection and ordering data" are only relevant to use in the TIA environment.

Selection and Ordering Data Order No.**only for TIA applications****SIMATIC Logon V1.4**

Single license for 1 installation

7 languages (German, English, French, Spanish, Italian, Chinese, Japanese), executes with Windows 2000 Professional SP4, Windows 2000 Server, Windows XP Professional SP2 or Windows Server 2003 SP1 and R2

Engineering software and electronic documentation on CD

Type of delivery: CD, license key disk, emergency key disk, certificate of license, terms and conditions

6ES7 658-7BX41-2YA0**SIMATIC Logon Upgrade to V1.4**

Single license for 1 installation

7 languages (German, English, French, Spanish, Italian, Chinese, Japanese), executes with Windows 2000 Professional SP4, Windows 2000 Server, Windows XP Professional SP2 or Windows Server 2003 SP1 and R2

Engineering software and electronic documentation on CD

Type of delivery: CD, license key disk, emergency key disk, certificate of license, terms and conditions

6ES7 658-7BX41-2YE0**Options****Chipcard reader USB**

Chipcard reader with USB interface, driver software and operating instructions

6ES7 652-0XX02-1XC0 B)**Chipcard**

Chipcard for chipcard reader; 1 card required per user; package with 10 chipcards

6ES7 652-0XX05-1XD1

B) Subject to export regulations: AL: N, ECCN: EAR99H

Options**Access security by means of chipcard reader**

A chipcard reader can be used to check a person's authorization to access and operate a single station or a client. This method of access security uses the chipcard as a "key" to the operator terminals. Operations are only allowed when the card is actually inserted in the reader.

The unmistakable identification of access rights is required in particular for plants which have to meet validation requirements. The chipcard reader is compliant with EN 55022 Class B and EN 50082-1 standards.

The reader is available with an USB interface for the connection of the operator station.

Note:

The reader with USB interface can only be used with SIMATIC Logon.

System-neutral components

2

Operating system

Overview

Operating system upgrade

When existing SIMATIC PCS 7 systems are updated to Version 7.0, it may also be necessary to upgrade the operating system.

If you replace your existing hardware by new SIMATIC PCS 7 Industrial Workstations from this catalog when carrying out an upgrade, the Windows XP Professional or Windows Server 2003 operating systems including 5 CAL (Client Access Licenses) required for SIMATIC PCS 7 V7.0 are already included in the scope of delivery. You can also purchase individual operating systems or additional Client Access Licenses (CAL) from Fujitsu Siemens Computers GmbH.

Contact address for quotations and orders

Fujitsu Siemens Computers GmbH

Mr. Dominikus Besserer

Phone: +49 821 804-2434

Fax: +49 821 804-2972

E-mail: dominikus.besserer@fujitsu-siemens.com

Note:

Please note when ordering that SIMATIC PCS 7 V7.0 is operated together with Windows XP Professional Service Pack 2 and Windows Server 2003 Service Pack 2.

Release 2 of Windows Server 2003 has not been approved for SIMATIC PCS 7 V7.0.

Overview



We offer a range of modern, powerful SIMATIC PCS 7 Industrial Workstations for the systems positioned in the SIMATIC PCS 7 system architecture above the controller level, e.g. for engineering, operation and monitoring (also via Internet/intranet), batch control, route control, asset management or IT applications etc. These are optimized for use as single station, client or server, and can be expanded specific to the system.

Design

Microsoft Windows operating system

The multi-language Microsoft Windows XP Professional or Server 2003 operating system as well as the SIMATIC PCS 7 system software for OS or ES/OS are preinstalled on the SIMATIC PCS 7 Industrial Workstation. The Microsoft Server 2003 operating system is supplied with 5 CALs (Client Access Licenses). You can purchase further CALs from Fujitsu Siemens Computers GmbH (see page 2/6).

Monitors and multi-VGA operation

The core component of the SIMATIC PCS 7 Industrial Workstation is a SIMATIC industrial PC without keyboard or monitor. This basic hardware can be combined with the industrial LCD monitors recommended in the Section "HMI devices/monitors" for SIMATIC PCS 7 in the Catalog "PC-based Automation" to suit the operating environment and the customer's requirements.

Using a multi-VGA graphics card, the visualization of a project/subproject when engineering or a plant/unit in process operation can be divided among up to 4 process monitors per operator station with application of different views (see page 2/16).

This is supported in the SIMATIC PCS 7 workstations designed as clients by additional hardware versions:

- SIMATIC PCS 7 OS Client RACK PC 547B WXP with multi-VGA graphics card "2 Screens" and
- SIMATIC PCS 7 OS Client RACK PC 547B WXP with multi-VGA graphics card "4 Screens"

Clients and single stations with a standard graphic interface module for controlling a process monitor can also be expanded by a multi-VGA graphics card "2 Screens" or "4 Screens" (see page 2/16).

System-neutral components

SIMATIC PCS 7 Industrial Workstation

2

Introduction

Options

Notes on the use of other basic hardware and non-SIMATIC software

Siemens guarantees the compatibility of hardware and software for system configurations based on components in this catalog.

The system test confirms that the system software of the SIMATIC PCS 7 process control system can be run on the SIMATIC PCS 7 Industrial Workstations offered in this catalog. Despite comprehensive tests, it cannot be excluded that the function of a SIMATIC PCS 7 system could be disturbed or interfered with as a result of additional non-SIMATIC software, i.e. software which has not been explicitly approved for SIMATIC PCS 7.

If you use hardware other than the basic hardware offered in this catalog, or additional non-SIMATIC software, this is at your own risk. If compatibility problems arise as a result of these hardware/

software components, the support provided for elimination thereof is not free of charge.

The licenses for plant bus communication via Industrial Ethernet, i.e. for Basic Communication Ethernet (BCE) and CP 1613 communication are bound to the SIMATIC PCS 7 Industrial Workstations. Depending on the selected type of communication, the SIMATIC PCS 7 Industrial Workstations for single stations and servers are delivered either with a BCE license or CP 1613 license. If you are not using SIMATIC PCS 7 V7.0 on SIMATIC PCS 7 Industrial Workstations, you additionally require a SIMATIC PCS 7 BCE V7.0 license (Order No. 6ES7 650-1CD07-2YB5) for all single stations or servers which are connected to the plant bus via a standard network card and not via a CP 1613.

Requirements on the configuration of the SIMATIC PCS 7 basic hardware

Depending on the application of the SIMATIC PCS 7 basic hardware, the following hardware requirements must be observed.

Minimum configuration of basic hardware depending on target system

Target systems				
Engineering station (ES)			●	
Engineering station with server operating system	●			
OS single station			●	
OS server			●	
OS client				●
Central archive server	●			
PCS 7 Web server			●	
Maintenance station (MS)			●	
BATCH single station			●	
BATCH server			●	
BATCH client				●
Common OS/BATCH client			●	
Route Control (RC) single station			●	
Route Control server			●	
Route Control client				●
Common OS/BATCH/Route Control single station	●			
Technical specifications of basic hardware				
Processor, clock	Intel Pentium IV, 2 GHz	Intel Pentium IV, 2 GHz	Intel Pentium IV, 2 GHz	
Main memory (RAM)	2 GB	1 GB	512 MB	
Hard disk				
• Storage capacity	120 GB	120 GB	80 GB	
• Size of C partition	20 GB	20 GB	20 GB	
Network adapter, communications interfaces	RJ45 connection (Fast Ethernet) for terminal bus (OS-LAN)	RJ45 connection (Fast Ethernet) for terminal bus (OS-LAN)	RJ45 connection (Fast Ethernet) for terminal bus (OS-LAN)	
	CP1613 A2 or RJ45 network card (Fast Ethernet) with BCE for plant bus (ES, as well as BATCH/OS/RC on one PC)	CP1613 or RJ45 network card (Fast Ethernet) with BCE for plant bus (ES, MS, OS single station/server and RC single station/server)	--	
Optical drive	DVD-ROM	DVD-ROM	DVD-ROM	

Recommended configuration of basic hardware depending on target system				
Target systems	Engineering station with server operating system		●	
	OS single station		●	
	OS server		●	
	OS client		●	
	Central archive server			●
	PCS 7 Web server		●	
	Maintenance station (MS)		●	
	BATCH single station		●	
	BATCH server		●	
	BATCH client		●	
	Common OS/BATCH client			●
	Route Control (RC) single station		●	
	Route Control server		●	
	Route Control client		●	
	Common OS/BATCH/Route Control single station			●
Engineering station with server operating system		●		
Technical specifications of basic hardware	PC type	SIMATIC Rack PC 547B		
	CPU			
	• Processor, clock	Intel Core 2 Duo E6600 / 2 x 2.4 GHz	Intel Core 2 Duo E6600 / 2 x 2.4 GHz	
	• Front Side Bus (FSB)	1066 MHz	1066 MHz	
	• Second Level Cache	4 MB	4 MB	
	Main memory (RAM)	2 GB	1 GB	
	Hard disks			
	• Number, storage capacity, type	2 x 250 GB SATA in RAID 1 network for server and ES/OS single stations; 1 x 250 GB SATA for client systems	1 x 250 GB SATA	
	• Size of C partition	50 GB	50 GB	
	Network adapter, communications interfaces	RJ45 connection (Gigabit Ethernet) for terminal bus (OS-LAN) on board CP1613 A2 or RJ45 Ethernet network card 10/100/1000 Mbit/s with BCE for plant bus (ES, MS, OS single station/ server and RC single station/server)	RJ45 connection (Gigabit Ethernet) for terminal bus (OS-LAN) on board --	
Optical drive	DVD writer (DVD±RW) for engineering station; DVD-ROM for all other target systems	DVD-ROM		

Additional recommendations/limitations

- It is generally of advantage for the system performance if the technical specifications of the basic hardware, e.g. clock, main memory or hard disk, are above the recommended values listed in the table. This particularly applies to multiproject engineering.
- A requirement for integration of PC-based SIMATIC PCS 7 basic hardware into the PC diagnostics of the SIMATIC PCS 7 asset management is the SIMATIC PC DiagMonitor software. This belongs to the scope of delivery of SIMATIC PCS 7 Industrial Workstations and SIMATIC PCS 7 BOX RTX/416 and cannot be executed on other systems.
- For long-term archiving with large quantity frameworks, we recommend the PCS 7 Premium server from the Catalog ST PCS 7.1 (Add-ons for the SIMATIC PCS 7 process control system) as the central archive server. However, the PCS 7 Premium server cannot be integrated into the PC diagnostics of the SIMATIC PCS 7 asset management.
- For increased data availability on the central archive server, we recommend a RAID hard disk system (at least RAID 1).

System-neutral components

SIMATIC PCS 7 Industrial Workstation

2

Basic hardware

Overview



The SIMATIC PCS 7 Industrial Workstations are based on a SIMATIC Rack PC of type 547B which features powerful, innovative Intel PC architecture of 19" design. They are certified by the CE marking for use in offices and industrial environments, and comply with the specific requirements of process control technology.

Application

Specially optimized versions are available for operation as single stations, servers or clients. The operating system and the following ES/OS software of the SIMATIC PCS 7 process control system are already preinstalled when delivered:

- Single station: PCS 7 Engineering Software for AS/OS (including OS Runtime software)
- Server: PCS 7 OS Software Server
- Client: PCS 7 OS Software Client

You only need the corresponding licenses in order to use the preinstalled SIMATIC PCS 7 software.

Note:

Please note the standard installation if you use the SIMATIC PCS 7 Industrial Workstations within the SIMATIC PCS 7 process control system for other tasks, e.g. as basic hardware for SIMATIC BATCH, SIMATIC Route Control, StoragePlus, Central Archive Server or PCS 7 Web Server. You can then extend or reject the existing SIMATIC PCS 7 installation, and restore it for the operating system using the restore DVD.

The CP 1613 communication integrated in the IE version of the SIMATIC PCS 7 Workstation for single stations and servers is a combination of CP 1613 communications processor and S7-1613 communications software. When using fault-tolerant automation systems, the SIMATIC PCS 7 Workstation requires the S7-REDCONNECT software instead of the S7-1613 communications software. The S7-REDCONNECT Upgrade is suitable for upgrading the communications software (for ordering data, see page 9/29).

Design

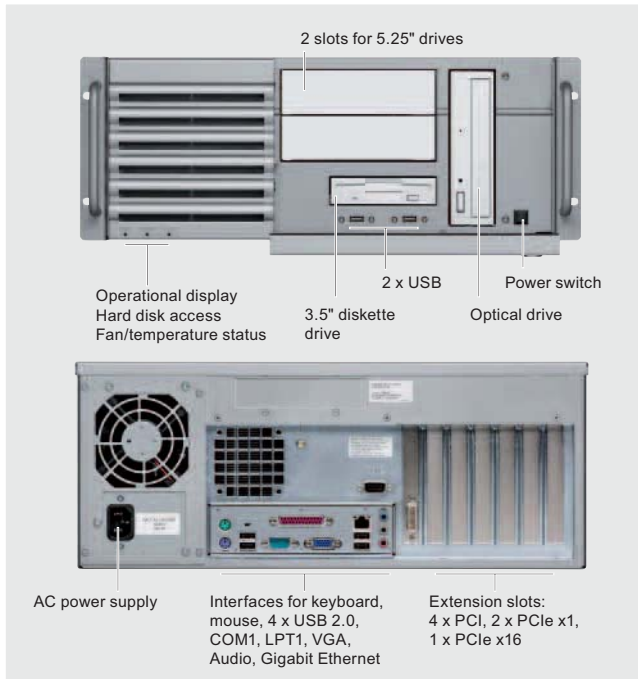

The SIMATIC PCS 7 Industrial Workstations of type Rack PC 547B have a painted all-metal housing of 19" rack design which is particularly protected against dust by a filter and pressurized ventilation. This mechanically and electromechanically rugged housing has a service-friendly design. The SIMATIC PCS 7 Industrial Workstations of type Rack PC 547B can be positioned and installed horizontally or vertically. High-grade components with high MTBF values and monitoring functions for the inner housing temperature, fan and program execution permit reliable 24-hour continuous operation at ambient temperatures between 5 and 40 °C.

The SIMATIC PCS 7 Industrial Workstations of type Rack PC 547B have the following features:

- Motherboard with future-oriented Intel architecture for modern Core 2 Duo processors, based on Intel 945G Express chipset
- Powerful AGP graphics with Dynamic Video Memory, sound (Line In, Line Out, Mic.) and 10/100/1000 Mbit/s Ethernet RJ45 port integrated onboard
- PCI-Express technology (1 PCIe x16 and 2 PCIe x1 slots)
- 6 slots for drives:
 - At the front: three 5.25" slots (1 occupied by DVD-ROM/DVD-RW) and
 - one 3.5" slot (occupied by diskette drive)
 - Inside: two 3.5" slots (occupied by 1 hard disk on the client, and 2 hard disks on the server and ES/OS single station)
- Increased system availability through RAID 1 with 2 SATA hard disks and NCQ technology (Native Command Queuing) on the server and ES/OS single station
- Second serial interface (for server) available (COM2)

- Total of 6 USB 2.0 interfaces (4 at rear, 2 at front)
- High electromagnetic compatibility (CE-certified for industrial and office environments)
- Dust protection by means of pressurized ventilation in conjunction with a front fan and a dust filter
- PC front complies with IP30 degree of protection when the front door is closed
- Front door can be locked to prevent unauthorized access to swap media, control elements and interfaces located at the front
- Easy and fast installation and maintenance of PC components: access to the front drives through a hinged front door; only 3 screws to open the device
- 3 LEDs on the front of the PC visualize the operating status:
 - Power (switched on)
 - HD (hard disk access)
 - Status (fan and temperature monitoring)
- Suitable for easy mounting with telescopic rails
- Easy to remove fixing bracket with handles
- Card hold-down device to secure PC modules during transportation and to protect them from vibration and shock
- Power supply unit with temperature-controlled fan
- Power connector lock for the power supply cable
- SIMATIC PC DiagMonitor diagnostics software for monitoring program execution (watchdog), temperature, fan speed, hard disk status and system failure (heartbeat); including operating hours counter
- Can be integrated into the system diagnostics of the SIMATIC PCS 7 asset management by means of SIMATIC PC DiagMonitor

Restore DVD

The operating system and SIMATIC PCS 7 software are pre-installed on the basic devices. Two restore DVDs are supplied for quickly restoring the delivered status if required.

- Restore DVD 1 only contains the operating system with default settings for optimum PCS 7 operation
- Restore DVD 2 contains a full installation (operating system plus ES/OS software including SQL server)

System-neutral components

SIMATIC PCS 7 Industrial Workstation

2

Basic hardware

Technical specifications

SIMATIC PCS 7 Industrial Workstation (single station/server/client)

Design and equipment features

Design	19" rack, 4 HU, for horizontal and vertical installation, prepared for easy mounting with telescopic rails, 19" fixing bracket with handle, easy to remove
Degree of protection to EN 60529	IP30 with front door closed; IP20 at rear
Motherboard	FSC D2156-S21
Chipset	Intel 945G Express

CPU

• Processor base	LGA 775
• Processor / clock	Intel Core 2 Duo E6600 / 2 x 2.4 GHz
• Front Side Bus (FSB)	1066 MHz
• Second Level Cache	4 MB

Main memory (SDRAM)

• Type	Dual channel DDR2-667 SDRAM (PC2-5300)
• Maximum configuration	4 memory bases in total (expandable to 4 GB)
• Standard configuration	Single station/server: 2 GB (2 x 1 GB) Client: 1 GB (2 x 512 MB)
Motherboard slots	4 x PCI (max. 265 mm long) 2 x PCIe x1 1 x PCIe x16

Slots for drives

• On the front	1 x 3.5" (occupied by diskette drive) 3 x 5.25" (1 occupied by DVD-ROM/DVD±RW)
• On the inside	2 x 3.5" for hard disk drives (2 occupied with server/single station; 1 occupied with client)
RAID controller	RAID controller Intel ICH7R with Intel Storage Manager software (onboard)

Hard disks

• Storage volumes / features	250 GB / 3.5" SATA, 8 MB cache, 7200 rpm, NCQ
• Single station/server	SATA-RAID 1 (mirror) with 2 hard disks
• Client	1 SATA hard disk

Technical specifications (cont.)

Interchangeable drives

• Diskette drive	3.5" diskette drive 1.44 MB
• DVD drive in ES/OS single station	DVD writer (DVD±RW) 5.25" ATAPI Read: • DVD-ROM: single layer 16x, dual layer 12x • DVD-R/+R: single layer 16x, dual layer 7x • DVD-RW/+RW 13x • CD-ROM/CD-R 48x, CD-RW 40x Write: • DVD+R 18x, DVD+RW 8x, DVD-R 18x, DVD-RW 6x • DVD+R9 (DL) 8x, DVD-R DL 8x • CD-R 48x, CD-RW 32x
• DVD drive in server/client	DVD-ROM 5.25" ATAPI Read: • DVD-ROM: single layer 16x, dual layer 8x • DVD+R/RW, DVD-R/RW 8x, DVD-RAM 2x • CD-ROM, CD-R 32x, CD-RW 20x

Graphics card

• Graphics memory	Dynamic video memory technology (up to 224 MB)
• Resolutions, frequencies, colors	• Up to 800 x 600 at 120 Hz, 32 bit colors • Up to 1280 x 1024 at 100 Hz, 32 bit colors • Up to 2048 x 1536 at 75 Hz, 16 bit colors

Mouse

Optical mouse

Interface modules / interfaces

• OS-LAN interface module	10/100/1000 Mbit/s Ethernet (RJ45) on board, Broadcom BCM5751 controller
• Plant bus interface module (single station/server), alternatives	Ethernet network card RJ45 (PCI) 10/100/1000 Mbit/s CP 1613 A2 communications processor
- RACK PC 547B BCE	
- RACK PC 547B IE	
• USB	6 x USB 2.0, 4 x at rear and 2 x at front, high current in each case
• Serial	Server: 1 x COM1 and 1 x COM2 (each V.24), 9-contact Sub-D connector Single station/client: 1 x COM1 (V.24), 9-contact Sub-D connector
• Parallel	1 x LPT1 (25-pin, EPP and ECP)
• Audio	1 x Line In; 1 x Micro In; 1 x Line Out (2 x 0.5 W/8 Ω); Realtek ALC262 Audio Codec
• VGA	1 x Sub-D socket, 15-contact
• Keyboard	1 x PS/2
• Mouse	1 x PS/2

Technical specifications (cont.)

Operating systems and diagnostics software

ES/OS single station/client	Microsoft Windows XP Professional MUI, 6 languages, selectable: German, English, French, Italian, Spanish, Chinese
Server	Microsoft Windows Server 2003 (standard edition) MUI, 6 languages, selectable: German, English, French, Italian, Spanish, Chinese
System-tested SIMATIC industrial software	SIMATIC PC DiagMonitor

Monitoring/diagnostics functions

Watchdog	<ul style="list-style-type: none"> Monitoring of program execution Monitoring time adjustable in the software
Temperature	Violation of permissible operating temperature
Fans	Speed monitoring for: <ul style="list-style-type: none"> Front fan Processor fan Power supply fan
Displays	Front LEDs <ul style="list-style-type: none"> Power (device switched on) HD (access to hard disk) Status (fan/temperature monitoring)

Safety

Protection class	Protection class I compliant with IEC 61140
Safety directives	EN 60950-1; UL60950; CSA C22.2 No. 60950-00

Noise level

Operation	< 45 dB (A) to DIN 45635
-----------	--------------------------

Electromagnetic compatibility (EMC)

Emitted interference (AC)	EN 55022 Class B; FCC Class A EN 61000-3-2 Class D, EN 61000-3-3
Immunity to conducted interference on the supply lines	± 2 kV (to IEC 61000-4-4, burst) ± 1 kV (to IEC 61000-4-5, symmetrical surge) ± 2 kV (to IEC 61000-4-5, unsymmetrical surge)
Immunity to interference on signal lines	± 2 kV (to IEC 61000-4-4, burst, length > 3 m) ± 2 kV (to IEC 61000-4-5, symmetrical surge, length > 30 m)
Immunity to static discharge	± 4 kV, contact discharge (to IEC 61000-4-2) ± 8 kV, atmospheric discharge (to IEC 61000-4-2)
Immunity to high-frequency irradiation	1 V/m, 2 to 2.7 GHz 10 V/m, 80 MHz to 1 GHz and 1.4 to 2 GHz, 80% AM (to IEC 61000-4-3) 10 V, 10 kHz to 80 MHz (to IEC 61000-4-6)
Magnetic field	100 A/m, 50 Hz/60 Hz (to IEC 61000-4-8)

Technical specifications (cont.)

Climatic conditions

Temperature	Tested according to IEC 60068-2-2, IEC 60068-2-1, IEC 60068-2-14
• Operation	+5 ... +40 °C (no DVD writer operation), +5 ... +35 °C (without limitation) CPU up to 65 W power loss Gradient: max. 10 °C/h, no condensation
• Storage/transport	-20 ... +60 °C Gradient: max. 20 °C/h, no condensation
Relative humidity	Tested according to IEC 60068-2-78, IEC 60068-2-30
• Operation	5 ... 80% at 25 °C (no condensation) Gradient: max. 10 °C/h, no condensation
• Storage/transport	5 ... 95% at 25 °C (no condensation) Gradient: max. 20 °C/h, no condensation

Mechanical environmental conditions

Vibrations	Tested according to IEC 60068-2-6, 10 cycles
• Operation	20 ... 58 Hz, amplitude 0.015 mm; 58 ... 200 Hz: 2 m/s ² Note: No mechanical interferences are tolerable when writing with CD/DVD writers.
• Storage/transport	5 ... 8.51 Hz, amplitude 3.5 mm; 8.51 ... 500 Hz: 9.8 m/s ²
Shock	Tested according to IEC 60068-2-27
• Operation	Half sine: 9.8 m/s ² , 20 ms, 100 shocks per axis Note: No mechanical interferences are tolerable when writing with CD/DVD writers.
• Storage/transport	Half sine: 250 m/s ² , 6 ms, 1000 shocks per axis

Approvals

CE living accommodation (emitted interference)	EN 61000-6-3:2001
CE industrial areas (noise immunity)	EN 61000-6-2:2005
cULus	60950-1

System-neutral components

SIMATIC PCS 7 Industrial Workstation

2

Basic hardware

Technical specifications (cont.)

Power supply

Nominal supply voltage	100 to 240 V AC, wide-range (90 to 264 V AC)
Frequency	50 ... 60 Hz (minimum 47 to maximum 63 Hz, sinusoidal)
Short-term voltage dip	16 ms at 0.85 of nominal supply voltage (max. 10 events per hour; recovery time min. 1 s)
Power consumption (with 210 W secondary)	310 W (approx 68% efficiency)
AC input current	Continuous current up to 7 A (up to 30 A for 5 ms during startup)
Max. current output	<ul style="list-style-type: none"> • +3.3 V: 24 A • +5 V: 26 A (total power for +3.3 V and +5 V max. 190 W) • +12 V: 15 A • -12 V: 0.2 A • +5 V_{aux}: 2 A

Dimensions and weights

Overall dimensions in mm (W x H x D)	433.5 x 176.5 x 445.5
Weight	16 ... 23 kg

Selection and Ordering Data

SIMATIC PCS 7 Industrial Workstation, single station version

SIMATIC PC in 19" rack, without monitor, keyboard and printer; Core 2 Duo E6600 2.4 GHz processor, 2 GB RAM (2 x 1 GB), sound, SATA-RAID 1 with 2 hard disks of 250 GB, graphics controller on board with dynamic video memory, DVD writer DVD±RW IDE, 3.5" diskette drive, optical mouse, Ethernet 10/100/1000 Mbit/s (RJ45) on board for connection to OS-LAN; SIMATIC PC DiagMonitor diagnostics software and 2 restore DVDs; SIMATIC PCS 7 ES/OS software preinstalled

Windows XP Professional MUI operating system (German, English, French, Italian, Spanish, Chinese)

<ul style="list-style-type: none"> • SIMATIC PCS 7 ES/OS 547B BCE WXP Connection to plant bus with Ethernet network card RJ45 (PCI) 10/100/1000 Mbit/s and Basic Communication Ethernet (BCE) for up to 8 automation systems (not fault-tolerant systems) 	6ES7 650-0NF07-0YX0	D)
<ul style="list-style-type: none"> • SIMATIC PCS 7 ES/OS 547B IE WXP Connection to plant bus with CP 1613 A2 communications processor 	6ES7 650-0NF07-0YX1	D)

Selection and Ordering Data

Order No.

SIMATIC PCS 7 Industrial Workstation, server version

SIMATIC PC in 19" rack, without monitor, keyboard and printer; Core 2 Duo E6600 2.4 GHz processor, 2 GB RAM (2 x 1 GB), sound, SATA-RAID 1 with 2 hard disks of 250 GB, graphics controller on board with dynamic video memory, DVD-ROM IDE, 3.5" diskette drive, optical mouse, Ethernet 10/100/1000 Mbit/s (RJ45) on board for connection to OS-LAN; SIMATIC PC DiagMonitor diagnostics software and 2 restore DVDs; SIMATIC PCS 7 OS software for server preinstalled

Windows Server 2003 MUI operating system (German, English, French, Italian, Spanish, Chinese)

<ul style="list-style-type: none"> • SIMATIC PCS 7 OS Server 547B BCE SRV03 Connection to plant bus with Ethernet network card RJ45 (PCI) 10/100/1000 Mbit/s and Basic Communication Ethernet (BCE) for up to 8 automation systems (not fault-tolerant systems) 	6ES7 650-0NH07-0YX0	D)
<ul style="list-style-type: none"> • SIMATIC PCS 7 OS Server 547B IE SRV03 Connection to plant bus with CP 1613 A2 communications processor 	6ES7 650-0NH07-0YX1	D)

SIMATIC PCS 7 Industrial Workstation, client version

SIMATIC PC in 19" rack, without monitor, keyboard and printer; Core 2 Duo E6600 2.4 GHz processor, 1 GB RAM (2 x 512 MB), SATA hard disk of 250 GB, graphics controller on board with dynamic video memory, DVD-ROM IDE, 3.5" diskette drive, optical mouse, Ethernet 10/100/1000 Mbit/s (RJ45) on board for connection to OS-LAN; SIMATIC PC DiagMonitor diagnostics software and 2 restore DVDs; SIMATIC PCS 7 OS software for client preinstalled

Windows XP Professional MUI operating system (German, English, French, Italian, Spanish, Chinese)

<ul style="list-style-type: none"> • SIMATIC PCS 7 OS Client 547B WXP - without multi-VGA graphics card 	6ES7 650-0NG07-0YX0	D)
<ul style="list-style-type: none"> - with Multi-VGA graphics card "2 Screens" 	6ES7 650-0NG07-0YA0	D)
<ul style="list-style-type: none"> - with Multi-VGA graphics card "4 Screens" 	6ES7 650-0NG07-0YB0	D)

D) Subject to export regulations: AL: N, ECCN: 5D992B1

Selection and Ordering Data Order No.

Additional and expansion components

Memory modules for expanding the main memory

• 512 MB memory expansion for SIMATIC Rack PC 547B (1 x 512 MB), DDR2-667 SDRAM	6ES7 648-2AF30-0HA0	B)
• 1 GB memory expansion for SIMATIC Rack PC 547B (2 x 512 MB), DDR2-667 SDRAM, kit for dual-channel technology	6ES7 648-2AF40-0HB0	B)
• 2 GB memory expansion for SIMATIC Rack PC 547B (2 x 1 GB), DDR2-667 SDRAM, kit for dual-channel technology	6ES7 648-2AF50-0HB0	B)

SIMATIC PC keyboard (USB connection)

• International key assignment	6ES7 648-0CB00-0YA0
--------------------------------	----------------------------

Tower kit for SIMATIC PCS 7 Industrial Workstations based on Rack PC 547B and IL 43

• Tower kit for conversion of a Rack PC into an industrial Tower PC	6ES7 648-1AA00-0XC0
---	----------------------------

3-m power cable for Rack PC ¹⁾

• For Great Britain	6ES7 900-0BA00-0XA0
• For Switzerland	6ES7 900-0CA00-0XA0
• For USA	6ES7 900-0DA00-0XA0
• For Italy	6ES7 900-0EA00-0XA0
• For China	6ES7 900-0FA00-0XA0

SIMATIC NET S7-REDCONNECT Upgrade

For communication with fault-tolerant AS systems, see page 9/29

B) Subject to export regulations: AL: N, ECCN: EAR99H

¹⁾ The PCS 7 systems are delivered as standard with a "European power cable". The country-specific versions listed above are required for some countries.

Accessories

Keyboards

The SIMATIC PCS 7 Industrial Workstations are delivered without a keyboard. The SIMATIC PC keyboard with USB connection, for example, is suitable for process operation with SIMATIC PCS 7.

The SIMATIC PC keyboard is a standard MF2 keyboard with 105 keys, without additional special functions. It combines the convenience of an office keyboard with the EMC of an industrial device. Standards/approvals: UL 1950, CSA C22.2 No. 950, FCC Part 15, subpart B, class B, VDE-GS (EN 60950/ZHI/618), CE, C-TICK-Mark (Australia).

Power supply cable for Rack PC

The SIMATIC PCS 7 systems are delivered as standard with a "European power cable". This can be used in Germany, France, Spain, Netherlands, Belgium, Sweden, Austria and Finland.

The country-specific versions listed in the Ordering data are required for other countries. The following picture shows the appearance of the power supply plugs:

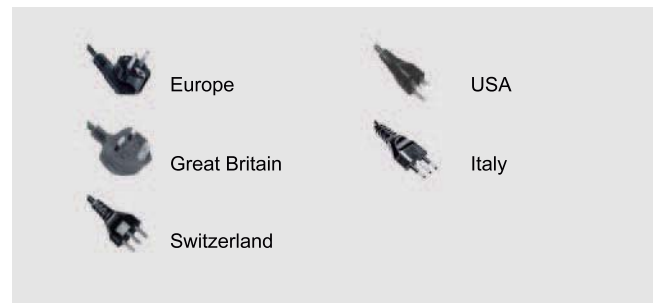

Country-specific power supply cables for Rack PC

Tower Kit

A Tower Kit for converting a SIMATIC PCS 7 Industrial Workstation of Rack PC design into an industrial Tower PC can be ordered as an option. The Tower Kit is suitable for SIMATIC PCS 7 Industrial Workstations based on the Rack PC types 547B and IL 43.



System-neutral components

SIMATIC PCS 7 Industrial Workstation

2

Multi-VGA graphics cards

Overview



The SIMATIC PCS 7 industrial workstations are supplied as standard with a graphics interface module for controlling one process monitor. The multi-VGA graphics cards "2 Screens" and "4 Screens" are available for multi-channel mode with 2 or up to 4 process monitors.

Using a multi-VGA graphics card, the visualization of a project/subproject when engineering or a plant/unit in process operation can be divided among up to 4 process monitors per operator station with application of different views. These project/plant sections can all be operated using just one keyboard and one mouse. Compared to single-channel mode, it is thus possible to enormously improve the efficiency, convenience and ergonomics of engineering and process control.

Technical specifications

Multi-VGA graphics cards

Memory	32 MB DDRAM per output
• Graphics card "2 Screens"	2 x 32 MB
• Graphics card "4 Screens"	4 x 32 MB
Clock	360 MHz integrated RAMDAC
Max. analog resolution per channel	2048 x 1536 at 24 bpp and 85 Hz
Max. digital resolution per channel	1280 x 1024
Electromagnetic compatibility (EMC)	
• Emitted interference	EN 55022 Class B
• Noise immunity	EN 50082
Slot requirement	1 PCI slot

Selection and Ordering Data

Order No.

Multi-VGA Graphics Card "2 Screens"

for operating 2 process monitors on 1 station

Type of delivery:
Dual graphics card, driver CD, manual, 1 dual DVI cable for 2 digital outputs, 2 adapters for VGA outputs

6ES7 652-0XX03-1XE0 B)

Multi-VGA Graphics Card "4 Screens"

for operating 4 process monitors on 1 station

Type of delivery:
Quad graphics card, driver CD, manual, 2 dual DVI cables for 4 digital outputs, 4 adapters for VGA outputs

6ES7 652-0XX03-1XE1 B)

B) Subject to export regulations: AL: N, ECCN: EAR99H

Overview

Operating devices

In addition to the mouse and SIMATIC PC keyboard described as operating devices in the Section "Basic hardware", you can find further devices such as fingerprint mouse, trackball or Ex-PC operator panel in the Catalog ST PCS 7.1 (Add-ons for the SIMATIC PCS 7 process control system).

Process monitors



We recommend the SCD 19101-D industrial monitor (LCD color monitor) for the SIMATIC PCS 7 process control system.

In addition, industrial LCD monitors with IP65 degree of protection (front) are available for installation in desks, control cabinets or 19" racks. These are available from:

- the Catalog ST PC "PC-based Automation" or
- the A&D Mall/CA 01 under "Automation Systems – PC-based Automation - Expansion Components - Industrial LCD Monitors"

Benefits

Outstanding characteristics of the SCD 19101-D LCD monitor include:

- Rugged, fail-safe and long-life industrial design:
 - High resistance to shock and vibration
 - Extremely high electromagnetic compatibility
 - Anti-glare and hardened mineral glass pane for high mechanical protection
 - IP20 degree of protection
 - Complies with CE standard "Industry"
- Modern design with exceptional ergonomics:
 - Sharp and high-contrast picture with uniform brightness
 - No flickering
 - Large reading angle up to 170° horizontal and vertical
 - Automatic picture adjustment (Auto Adjust)
- No X-rays
- Low energy consumption and heat development
- Small space requirement and low weight
- Configuration using on-screen display (OSD)
- Long service life

Technical specifications

Monitor	SCD 19101-D
Screen	19" (48 cm) TFT color monitor, 1280 x 1024 pixels, 16 million colors
Line frequency	50 ... 97 kHz
Image refresh rate	30 ... 100 Hz
Power supply	110/230 V AC
Dimensions (WxHxD) in mm	465 x 444 x 91 (depth of stand 240)
Degree of protection	IP20
Weight	Approx. 10 kg

Detailed technical data can be found in

- Catalog ST PC "PC-based Automation" or
- the Mall/CA 01 at "Automation systems - Monitors, printers and input devices for industry"

Selection and Ordering Data

Order No.

SCD 19101-D industrial LCD monitor
(same design as SCD 1898-I)
Desktop unit, 230 V AC,
48 cm (19") screen diagonal,
horizontal frequency 50...97 kHz,
IP20 degree of protection

6GF6 220-1DA01 B)

Additional and expansion components

Connection cable

- Video + Touch, 1.8 m long **6AV8 107-0BA00-0AA0**
- Video + Touch, 5 m long **6AV8 107-0DA00-0AA0**
- Video + Touch, 10 m long **6AV8 107-0FA00-0AA0**
- Video, connecting cable 20 m long **6AV8 107-0HB00-0AA0**

B) Subject to export regulations: AL: N, ECCN: EAR99H

System-neutral components

SIMATIC PCS 7 Industrial Workstation

2

Special configurations

Overview

The SIMATIC PCS 7 Industrial Workstations offered in the catalog section "Basic hardware" already cover the majority of applications. In the case of special system requirements, particularly if several supplementary/expansion components such as multi-VGA graphics card, signal module or memory expansion have to be integrated at the same time, we also offer the possibility for ordering completely assembled special configurations of these SIMATIC PCS 7 Industrial Workstations.

A special SIMATIC PCS 7 Industrial Workstation can be compiled interactively on the Internet using a configurator, and its Order No. generated in the process. This can subsequently be transferred to the shopping cart for ordering.

Configurator in the A&D Mall

The configurator "Special SIMATIC PCS 7 Industrial Workstations" is integrated in the catalog & online ordering system "A&D Mall" (www.siemens.com/automation/mall). It can be accessed there in two manners:

Selection using quick link "Configuration list"

A selection window in which all available configurators are categorized according to technical criteria is opened when you click the quick link "Configuration list" on the right side of the A&D Mall (see figure). You can find the configurator "Special SIMATIC PCS 7 Industrial Workstations" here in the category "Process automation".



Selection using the "Siemens A&D product tree"

If you click the link "Products" at the second position in the horizontal primary navigation (see blue area at the top in the figure), the "Siemens A&D product tree" is displayed on the left. Navigate there from "Process automation" via "Process control systems", "SIMATIC PCS 7 V7.0" and "SIMATIC PCS 7 Industrial Workstations" on to "Special configurations". Select the "Configurators" tab here, and then the configurator "Special SIMATIC PCS 7 Industrial Workstations".

Starter systems



3/2	SIMATIC PCS 7 BOX
3/2	Introduction
3/4	SIMATIC PCS 7 BOX RTX
3/8	SIMATIC PCS 7 BOX 416
3/13	Runtime Basic Packages



Starter systems

SIMATIC PCS 7 BOX

Introduction

Overview

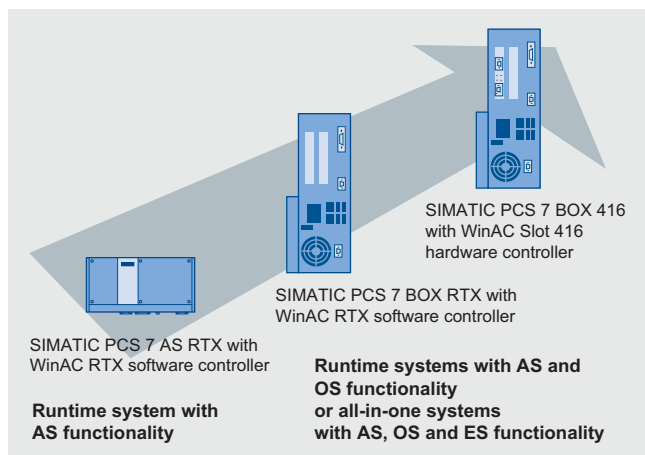

Scalable automation performance in the bottom performance range of SIMATIC PCS 7 (for SIMATIC PCS 7 AS RTX, see page 10/4)

SIMATIC PCS 7 BOX systems are compact and rugged industrial PCs as low-price starter solutions for process automation with SIMATIC PCS 7. They are available in two versions:

- SIMATIC PCS 7 all-in-one system with functionality for automation (AS), HMI (OS) and engineering (ES)
- SIMATIC PCS 7 Runtime system with AS and OS functionality

Expanded by distributed process I/Os on the PROFIBUS, each version represents a complete process control system for small applications.

Application

The SIMATIC PCS 7 BOX starter systems can be used for various applications:

- Small production applications
- Enclosed subprocesses (package units)
- Automation of a laboratory or test center

As a fully adequate member of the SIMATIC PCS 7 range, they work with the PCS 7 standard system software, are scalable, and can be expanded without destroying the compatibility. However, the engineering and runtime licenses for AS and OS are limited to 2000 POs (process objects).

Use as asset management station

SIMATIC PCS 7 BOX can be incorporated into the PC diagnostics of the SIMATIC PCS 7 asset management using the SIMATIC PC DiagMonitor software. Equipped as an all-in-one system with software licenses for SIMATIC PDM and SIMATIC PCS 7 asset management, they are additionally suitable for use as a maintenance station. For further information, see Chapter "Asset management".

Design

Two SIMATIC PCS 7 BOX systems with different performances are currently available:

- SIMATIC PCS 7 BOX RTX with WinAC RTX software controller
- SIMATIC PCS 7 BOX 416 with WinAC Slot 416 hardware controller

Together with the compact SIMATIC PCS 7 AS RTX Microbox automation system (see page 10/4), these allow finer scaling of the automation performance in the bottom performance range of SIMATIC PCS 7. It is then possible to react more variably to individual customer requirements with small applications. With regard to the achievable quantity framework, the SIMATIC PCS 7 BOX systems are approximately comparable with the following standard automation systems:

- SIMATIC PCS 7 BOX 416 with an AS 416
- SIMATIC PCS 7 BOX RTX with an AS 414

In a direct comparison of the two systems, the SIMATIC PCS 7 BOX RTX impresses primarily due to the following advantages:

- Low price
- Very fast program execution

Particular advantages of the SIMATIC PCS 7 BOX 416 are:

- High availability
- Support of changes to the configuration during runtime (CiR) through the stand-alone WinAC Slot CPU

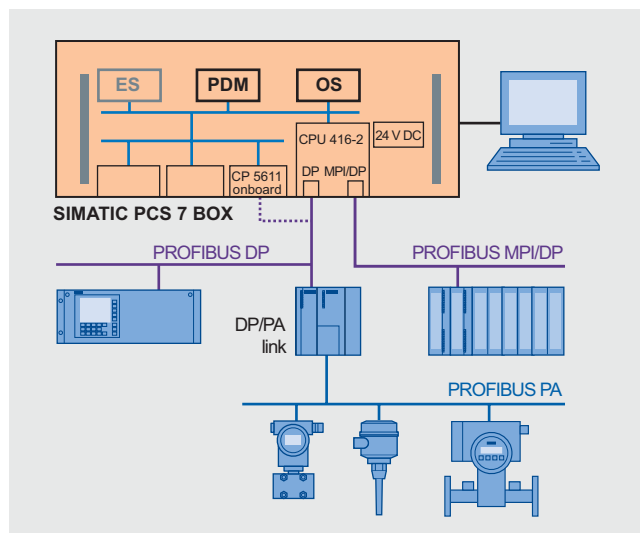

Stand-alone operation using example of a SIMATIC PCS 7 BOX 416

Starter systems

SIMATIC PCS 7 BOX

Introduction

3

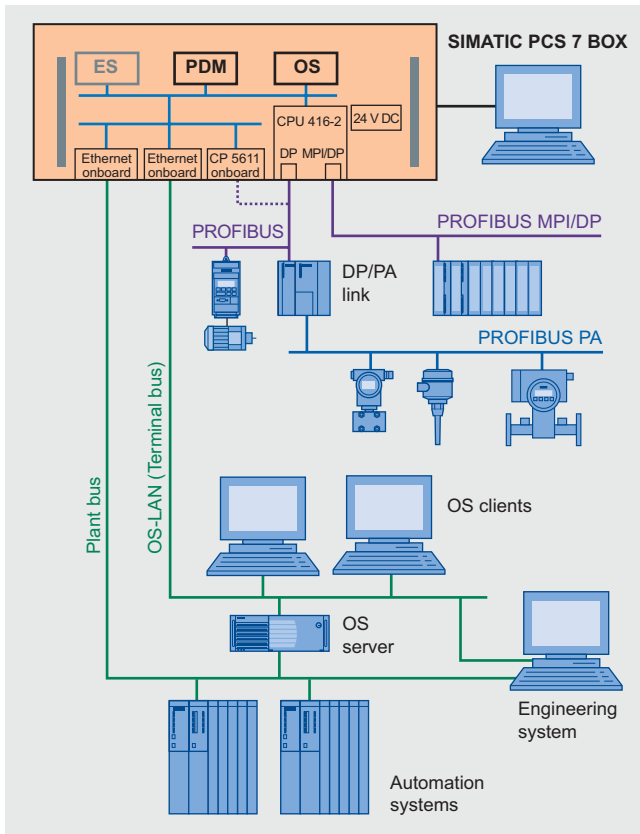

Integration in the SIMATIC PCS 7 system network using example of the SIMATIC PCS 7 BOX 416

SIMATIC PCS 7 BOX systems (SIMATIC PCS 7 BOX RTX as well as SIMATIC PCS 7 BOX 416) are based on the industrial SIMATIC Box PC 627B which permits combination of the frequently distributed PCS functionality for automation, HMI and engineering in one system. They use standard system software of SIMATIC PCS 7 V7.0, and are integrated in the SIMATIC PCS 7 engineering and the PCS 7 project wizard. This guarantees full compatibility with SIMATIC PCS 7 V7.0.

SIMATIC PCS 7 BOX can be configured either using the engineering software integrated in the system or a central engineering system. OS-specific changes in the configuration on the SIMATIC PCS 7 BOX or on the central engineering system can be downloaded online, i.e. without terminating OS process operation.

SIMATIC PCS 7 BOX support ET 200M, ET 200ISP and ET 200S remote I/O stations connected over PROFIBUS DP by means of a comprehensive range of low-cost signal/function modules as well as intelligent field/process devices connected directly over PROFIBUS DP/PA.

SIMATIC PCS 7 BOX systems can be operated in stand-alone mode and also in the system network with other SIMATIC PCS 7 system components. The two architectures are illustrated using examples of the SIMATIC PCS 7 BOX 416.

A system produced with SIMATIC PCS 7 BOX can be expanded at any time by further SIMATIC PCS 7 hardware and software components. It is just as easy to integrate SIMATIC PCS 7 BOX into existing SIMATIC PCS 7 systems. The connections on the plant bus and OS-LAN (terminal bus) are made using the Ethernet interfaces integrated in the SIMATIC PCS 7 BOX.

The engineering licenses as well as the runtime licenses for AS and OS are administered by the engineering software.

With a SIMATIC PCS 7 BOX all-in-one system, the runtime licenses for AS and OS are components of the engineering software, and can be expanded by AS/OS Software Engineering PowerPacks to a maximum of 2000 POs.

With a SIMATIC PCS 7 BOX runtime system, the OS Runtime licenses can be expanded by OS Software PowerPacks, the AS Runtime licenses by further AS Runtime licenses for 100 or 1000 POs to a maximum of 2000 POs. The process objects of additional AS Runtime licenses are then added to process objects which already exist. The number and type (100 or 1000) of additional AS Runtime licenses are only limited by the expansion limit.

Starter systems

SIMATIC PCS 7 BOX

SIMATIC PCS 7 BOX RTX

Overview

3



The SIMATIC PCS 7 BOX RTX equipped with a WinAC RTX software controller features an exceptional price/performance ratio. With regard to the automation performance, it is positioned slightly below the SIMATIC PCS 7 BOX 416, but is primarily characterized by its very fast program execution.

The WinAC RTX software controller working on the SIMATIC Box PC 627B basic hardware only generates a low basic load, and particularly exhibits its strengths in applications characterized by real-time demands and a deterministic response.

Design

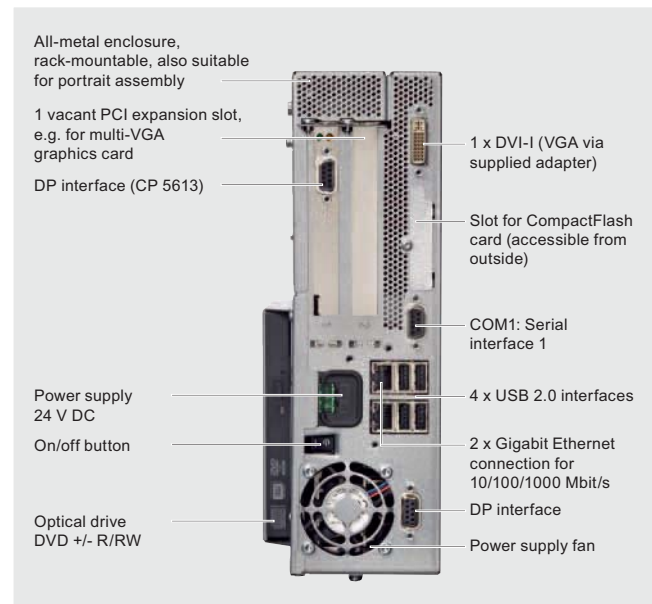

SIMATIC PCS 7 BOX RTX design

SIMATIC PCS 7 BOX RTX systems are offered in the form of two product bundles:

- Preinstalled SIMATIC PCS 7 all-in-one system with AS, ES and OS functionality, including AS/OS Engineering and Runtime licenses for 250 POs
- Preinstalled SIMATIC PCS 7 runtime system with AS and OS functionality, including AS/OS Runtime license for 250 POs

These bundles can be extended by the following expansion components (see also page 2/15 and catalog on PC-based Automation):

- SIMATIC PCS 7 PowerPacks/Runtime licenses for up to 2000 POs
- AS/OS Software Engineering PowerPack for all-in-one system
- OS Software Single Station PowerPack and AS Runtime license for runtime system
- SIMATIC PDM package for PCS 7
- SIMATIC PC keyboard
- LC and CRT displays for office and industrial environments

Technical specifications

Basic hardware: SIMATIC Box PC 627B

Design and equipment features

Design	Rack-mountable device with rugged metal enclosure, suitable for wall and portrait mounting
Degree of protection to EN 60529	IP20
CPU	
• Processor	Intel Core 2 Duo T7400 2.16 GHz
• Front Side Bus	667 MHz
• Second Level Cache	4 MB
Chipset	Intel 945 GM
Main memory	2 GB DDR2-667 SDRAM (2 x 1 GB)
Graphics	
• Graphics controller	Intel 2D/3D GMA950, integrated in chipset
• Graphics memory	Dynamic video memory 8 to 128 MB
• Resolutions/colors/frequencies	<ul style="list-style-type: none"> VGA: Max. 1600 x 1200 / 32 bit colors / 85 Hz DVI: Max. 1600 x 1200 / 32 bit colors / 60 Hz

Drives

• Flash drive	For CompactFlash card
• Hard disk	3.5" SATA, 160 GB
• Optical drive	DVD ± R/RW
• Diskette drive	Connectable via USB (not included in scope of delivery)

Interfaces

• PROFIBUS (12 Mbit/s)	1 x 9-contact Sub-D socket, CP 5611-compatible, 1 x 9-contact Sub-D socket, CP 5613
• Ethernet	2 x 10/100/1000 Mbit/s (RJ 45)
• USB	4 x USB 2.0/high-speed (2 x high-current)
• Serial	1 x COM1 (V.24), 9-contact Sub-D connector
• Parallel	-
• Graphics connection	1 x DVI-I (DVI/VGA combined): <ul style="list-style-type: none"> DVI: digital VGA analog
• Keyboard/mouse	Connectable via USB (keyboard not included in scope of delivery)

Operating system and diagnostics software

Operating system	Windows XP Professional MUI preinstalled on hard disk and enclosed on restore DVD, no activation necessary
System-tested SIMATIC industrial software	SIMATIC PC DiagMonitor

Technical specifications (cont.)

Monitoring/diagnostics functions

Watchdog	<ul style="list-style-type: none"> Monitoring of program execution Can be parameterized for fault scenario or restart Monitoring time adjustable in the software
Temperature	<ul style="list-style-type: none"> Processor temperature Air inlet temperature Temperature in vicinity of power supply (via SIMATIC PC DiagMonitor and SIMATIC PCS 7 Asset Management)
Fans	<ul style="list-style-type: none"> Failure of device fan and power supply fan (via SIMATIC PC DiagMonitor and SIMATIC PCS 7 Asset Management)
Operating hours counter	(via SIMATIC PC DiagMonitor and SIMATIC PCS 7 Asset Management)
Displays	<ul style="list-style-type: none"> Two-digit 7-segment display for visualization of POST codes during BIOS booting Two programmable status LEDs

Safety

Protection class	Protection class I compliant with IEC 61140
Safety directives	EN 61131-2; UL508; CSA C22.2 No 142

Noise level

Operation	< 55 dB (A) to DIN 45635-1
-----------	----------------------------

Electromagnetic compatibility (EMC)

Emitted interference	EN 55022 Class B; EN 61000-3-2 Class D EN 61000-3-3; FCC Class A
Immunity to conducted interference on the supply lines	± 2 kV (to IEC 61000-4-4; burst) ± 1 kV (to IEC 61000-4-5; symmetrical surge) ± 2 kV (to IEC 61000-4-5; asymmetrical surge)
Immunity to interference on signal lines	± 1 kV (to IEC 61000-4-4; burst; length < 3 m) ± 2 kV (to IEC 61000-4-4; burst; length > 3 m) ± 2 kV (to IEC 61000-4-5; surge; length > 30 m)
Immunity to static discharge	± 6 kV contact discharge (to IEC 61000-4-2) ± 8 kV air discharge (to IEC 61000-4-2)
Immunity to high-frequency irradiation	10 V/m, 80 to 1000 MHz and 1.4 to 2 GHz, 80% AM (to IEC 61000-4-3) 1 V/m, 2 to 2.7 GHz, 80% AM (to IEC 61000-4-3) 10 V, 9 kHz to 80 MHz, 80% AM (to IEC 61000-4-6)
Immunity to magnetic fields	100 A/m, 50/60 Hz (to IEC 61000-4-8)

Starter systems

SIMATIC PCS 7 BOX

SIMATIC PCS 7 BOX RTX

3

Technical specifications (cont.)

Climatic conditions

Temperature	Tested according to IEC 60068-2-1, IEC 60068-2-2, IEC 60068-2-14
• Operation	<ul style="list-style-type: none"> +5 to +45 °C (with DVD writer, only up to +40 °C) +5 to +50 °C (power of all slots max. 20 W) +5 to +55 °C (power of all slots max. 10 W)
• Storage/transport	-20 to +60 °C
• Gradient	Operation: max. 10 °C/h; storage: 20 °C/h, no condensation
Relative humidity	Tested according to IEC 60068-2-78, IEC 60068-2-30
• Operation	5 to 80% at 25 °C (no condensation)
• Storage/transport	5 to 95% at 25 °C (no condensation)

Mechanical environmental conditions

Vibrations	Tested according to IEC 60068-2-6
• Operation	10 to 58 Hz: 0.075 mm, 58 to 500 Hz: 9.8 m/s ² Limitation with DVD writer: 10 to 58 Hz: 0.019 mm / 58 to 500 Hz: 2.5 m/s ² Limitation with portrait assembly: 10 to 58 Hz: 0.0375 mm / 58 to 500 Hz: 4.9 m/s ²
• Storage/transport	5 to 9 Hz: 3.5 mm, 9 to 500 Hz: 9.8 m/s ²
Shock	Tested according to IEC 60068-2-27, IEC 60068-2-29
• Operation	50 m/s ² , 30 ms Limitation with portrait assembly: 25 m/s ² , 30 ms
• Storage/transport	250 m/s ² , 6 ms

Approvals

CE living accommodation	
• Emitted interference	EN 61000-6-3: 2001
• Noise immunity	EN 61000-6-1: 2001
CE industrial environment	
• Emitted interference	EN 61000-6-4: 2001
• Noise immunity	EN 61000-6-2: 2005
cULus	UL 60950-1, Report E11 5352 and CAN/CSA-C22.2 No. 60950-1; UL508 and CAN/CSA-C22.2 No. 142;

Power supply (electrically isolated)

Power supply	24 V DC (-15% / +20%), SELV
DC input current	Continuous current up to 8 A (up to 14 A for 30 s during startup)
Max. power consumption (at 24 V DC)	210 W

Dimensions and weights

Dimensions including DVD writer (W x H x D) in mm	297 x 267 x 100
Weight	Approx. 7 kg

Technical specifications (cont.)

Automation: WinAC software PLC

CPU	WinAC RTX software controller for SIMATIC Box PC 627B with Windows XP Professional operating system, preconfigured for SIMATIC PCS 7
-----	--

All-in-one system

Preinstalled software/license	PCS 7 Engineering Software V7.0 for AS/OS
Number of process objects (AS/OS engineering and runtime)	250 POs (expandable per PowerPack to 2000 POs)

Runtime system

Preinstalled software/license	PCS 7 OS Software Single Station V7.0 and SIMATIC PCS 7 AS Runtime license
Number of process objects (runtime)	<ul style="list-style-type: none"> 250 POs for OS (expandable per PowerPack to 2000 POs) 250 POs for AS (expandable per AS Runtime license)

Starter systems

SIMATIC PCS 7 BOX

SIMATIC PCS 7 BOX RTX

3

Selection and Ordering Data	Order No.	Selection and Ordering Data	Order No.
SIMATIC PCS 7 BOX RTX all-in-one system (ES, OS and AS) assembled and preinstalled, comprising: <ul style="list-style-type: none"> • SIMATIC Box PC 627B, 24 V DC, with Windows XP Professional MUJ operating system (German, English, French, Italian, Spanish), WinAC RTX software controller and SIMATIC PC DiagMonitor diagnostics software • Mouse • SIMATIC PCS 7 Engineering Software V7.0 for AS/OS including AS/OS Runtime license for productive operation, 250 POs, 5 languages (German, English, French, Italian, Spanish), floating license for 1 user 	6ES7 650-2QA07-0YX0 D)	SIMATIC PCS 7 PowerPacks/licenses for runtime system SIMATIC PCS 7 PowerPack OS Software Single Station V7.0 for extending the OS Software Single Station 5 languages (German, English, French, Italian, Spanish), executes with Windows XP Professional, single license for 1 installation Type of delivery: License key disk, emergency key disk, certificate of license, terms and conditions <ul style="list-style-type: none"> • From 250 POs to 1000 POs • From 1000 POs to 2000 POs 	6ES7 658-2AB07-0YD0 6ES7 658-2AC07-0YD0
SIMATIC PCS 7 BOX RTX runtime system (OS and AS) assembled and preinstalled, comprising: <ul style="list-style-type: none"> • SIMATIC Box PC 627B, 24 V DC, with Windows XP Professional MUJ operating system (German, English, French, Italian, Spanish), WinAC RTX software controller and SIMATIC PC DiagMonitor diagnostics software • Mouse • SIMATIC PCS 7 OS Software Single Station V7.0, 250 POs, 5 languages (German, English, French, Italian, Spanish), single license for 1 installation • SIMATIC PCS 7 AS Runtime license, 250 POs, 5 languages (German, English, French, Italian, Spanish), single license for 1 installation 	6ES7 650-2QB07-0YX0 D)	SIMATIC PCS 7 AS Runtime license (can be added to existing licenses) 5 languages (German, English, French, Italian, Spanish), executes with Windows XP Professional, single license for 1 installation Type of delivery: License key disk, certificate of license, terms and conditions <ul style="list-style-type: none"> • 100 POs • 1000 POs 	6ES7 653-2BA00-0XB5 6ES7 653-2BB00-0XB5
Additional and expansion components SIMATIC PCS 7 PowerPacks for all-in-one system SIMATIC PCS 7 PowerPack Engineering Software AS/OS V7.0 for extending the engineering software for AS/OS 5 languages (German, English, French, Italian, Spanish), executes with Windows XP Professional, floating license for 1 user Type of delivery: License key disk, emergency key disk, certificate of license, terms and conditions <ul style="list-style-type: none"> • From 250 to 1000 POs, including AS/OS Runtime license • From 1000 to 2000 POs, including AS/OS Runtime license 		SIMATIC PDM SIMATIC PDM PCS 7 V6.0 Complete package for integration into the engineering toolset of the SIMATIC PCS 7 engineering system 5 languages (German, English, French, Italian, Spanish), executes with Windows 2000 Professional or Windows XP Professional, floating license for 1 user, with: <ul style="list-style-type: none"> • SIMATIC PDM Basic • Option "Integration in STEP 7/PCS 7" • Option "Routing through S7-400" • Option "128 TAGs" Software and electronic documentation on toolset DVD Type of delivery: <ul style="list-style-type: none"> • License key disk, emergency key disk, certificate of license, terms and conditions • 2 CDs with SIMATIC PDM V6.0 and device library Note: TAG options and PowerPacks: see page 4/14	
D) Subject to export regulations: AL: N, ECCN: 5D992B1		Further SIMATIC PCS 7 system software <ul style="list-style-type: none"> • SIMATIC BATCH: see Section "Batch automation" • SIMATIC PCS 7 asset-management: see Section "Asset management" 	
		SIMATIC PC keyboard (USB connection) <ul style="list-style-type: none"> • International key assignment 	6ES7 648-0CB00-0YA0

Starter systems

SIMATIC PCS 7 BOX

SIMATIC PCS 7 BOX 416

Overview

3



The SIMATIC PCS 7 BOX 416 equipped with a WinAC Slot 416 V4.0 hardware controller is based like the SIMATIC PCS 7 BOX RTX on the industrial PC SIMATIC Box PC 627B. With regards to the automation performance, it is positioned slightly above the SIMATIC PCS 7 BOX RTX, and is particularly recommendable if high availability or changes to the configuration during operation (CiR) are relevant factors for the selection.

Design

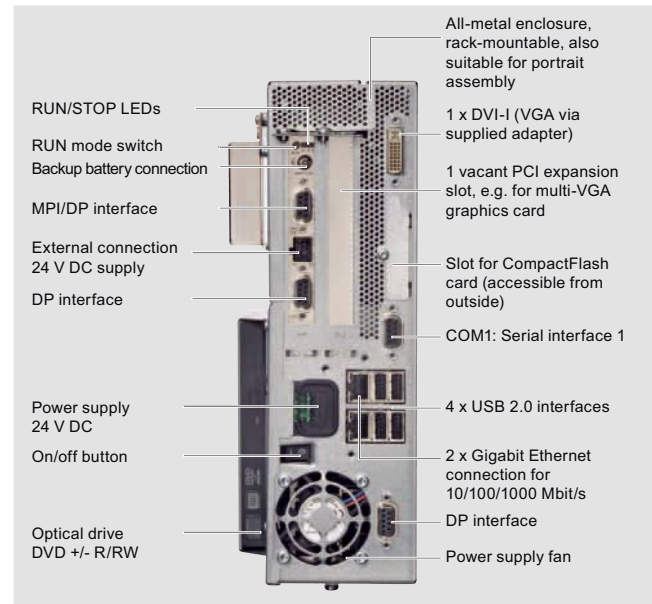

Design of SIMATIC PCS 7 BOX 416

SIMATIC PCS 7 BOX 416 systems are offered in the form of two product bundles:

- Preinstalled SIMATIC PCS 7 all-in-one system with AS, ES and OS functionality, including AS/OS Engineering and Runtime licenses for 250 POs
- Preinstalled SIMATIC PCS 7 runtime system with AS and OS functionality, including AS/OS Runtime license for 250 POs

These bundles can be extended by the following expansion components (see also page 2/15 and catalog on PC-based Automation):

- SIMATIC PCS 7 PowerPacks/Runtime licenses for up to 2000 POs
 - AS/OS Software Engineering PowerPack for all-in-one system
 - OS Software Single Station PowerPack and AS Runtime license for runtime system
- SIMATIC PDM package for PCS 7
- SIMATIC PC keyboard
- LC and CRT displays for office and industrial environments
- SITOP smart power supply 230 AC/24 V DC, 240 W
- SITOP DC UPS module 15 A with RS 232 interface
- DC UPS software for further processing of the signals sent by the DC UPS module with RS 232 interface on the PC (status visualization as well as definition of response to various operating states of the DC UPS module), executes with Windows NT, 2000 and XP; freeware for downloading at www.siemens.com/sitop
- SITOP battery module 24 V DC/20 A/7 Ah for DC UPS module 15 A

Function

WinAC Slot 416 V4.0

Through use of the WinAC Slot 416 V4.0, it is possible for the automation program in the Slot CPU to execute completely autonomously from the SIMATIC Box PC and its Windows operating system. Therefore the system can be restarted even if the SIMATIC Box PC is switched off or faulty. 24 V DC from a separate source is connected to the Slot CPU to provide a power supply independent of the PC. Neither software faults on the PC side, nor a power loss, nor rebooting of the PC have an effect on execution of the automation program in the Slot CPU.

If one of the following events occurs, the automation program is immediately informed and can thus react accordingly, e.g. by intermediate storage of production data and transfer of the system to a defined status:

- Shutting-down of the Windows operating system
- Fault in the Windows operating system ("blue screen")
- Failure of PC-internal communication
- Switching-off of the PC (Separate 24 V DC supply required)

With the SIMATIC PCS 7 BOX 416, the process I/O is connected via the two PROFIBUS DP ports of the WinAC Slot 416 V4.0. In conjunction with SIMATIC PCS 7 V7.0, the WinAC Slot 416 V4.0 also permits changes to the configuration during operation (CiR). The type and scope of online modifications depend on the process I/O used.

Since SIMATIC PDM can only access field devices on the PROFIBUS DP via the onboard CP 5611 communications processor, an additional link is required between the DP port and the CP 5611. The plug required belongs to the scope of delivery of the SIMATIC PCS 7 BOX 416.

Use with SIMATIC BATCH

SIMATIC PCS 7 BOX 416 systems can also be used for automation of batch processes with SIMATIC BATCH. The capacity of SIMATIC BATCH is limited to 10 UNITS (instances of plant units) in this case. The following SIMATIC BATCH option packages can be executed on the SIMATIC PCS 7 BOX in addition to the SIMATIC BATCH Server Basic Package for up to 10 UNITS:

- Batch Control Center
- Recipe System
- Batch Planning
- Hierarchical Recipe
- ROP Library
- Separation Procedures/Formulas

Use with SIMATIC Route Control

SIMATIC PCS 7 BOX 416 systems are not only suitable for automation of batch processes with SIMATIC BATCH, but also for control of material transports with SIMATIC Route Control. The capacity of SIMATIC Route Control is limited to 30 simultaneous material transports in this case. The SIMATIC Route Control Server and SIMATIC Route Control Center runtime software is then executed on the SIMATIC PCS 7 BOX 416. The Route Control Engineering is also possible on a SIMATIC PCS 7 BOX 416 all-in-one system.

Technical specifications

Basic hardware: SIMATIC Box PC 627B

Design and equipment features

Design	Rack-mountable device with rugged metal enclosure, suitable for wall and portrait mounting
Degree of protection to EN 60529	IP20
CPU	
• Processor	Intel Core 2 Duo T7400 2.16 GHz
• Front Side Bus	667 MHz
• Second Level Cache	4 MB
Chipset	Intel 945 GM
Main memory	2 GB DDR2-667 SDRAM (2 x 1 GB)
Graphics	
• Graphics controller	Intel 2D/3D GMA950, integrated in chipset
• Graphics memory	Dynamic video memory 8 to 128 MB
• Resolutions/colors/frequencies	<ul style="list-style-type: none"> • VGA: Max. 1600 x 1200 / 32 bit colors / 85 Hz • DVI: Max. 1600 x 1200 / 32 bit colors / 60 Hz

Drives

• Flash drive	For CompactFlash card
• Hard disk	3.5" SATA, 160 GB
• Optical drive	DVD ± R/RW
• Diskette drive	Connectable via USB (not included in scope of delivery)

Interfaces

• PROFIBUS/MPI	1 x 9-contact Sub-D socket, 12 Mbit/s (electrically isolated, CP 5611-compatible)
• Ethernet	2 x 10/100/1000 Mbit/s (RJ 45)
• USB	4 x USB 2.0/high-speed (2 x high-current)
• Serial	1 x COM1 (V.24), 9-contact Sub-D connector
• Parallel	-
• Graphics connection	1 x DVI-I (DVI/VGA combined): <ul style="list-style-type: none"> • DVI: digital • VGA analog
• Keyboard/mouse	Connectable via USB (keyboard not included in scope of delivery)

Operating system and diagnostics software

Operating system	Windows XP Professional MUI preinstalled on hard disk and enclosed on restore DVD, no activation necessary
System-tested SIMATIC industrial software	SIMATIC PC DiagMonitor

Starter systems

SIMATIC PCS 7 BOX

SIMATIC PCS 7 BOX 416

3

Technical specifications (cont.)

Monitoring/diagnostics functions

Watchdog	<ul style="list-style-type: none"> Monitoring of program execution Can be parameterized for fault scenario or restart Monitoring time adjustable in the software
Temperature	<ul style="list-style-type: none"> Processor temperature Air inlet temperature Temperature in vicinity of power supply (via SIMATIC PC DiagMonitor and SIMATIC PCS 7 Asset Management)
Fans	<ul style="list-style-type: none"> Failure of device fan and power supply fan (via SIMATIC PC DiagMonitor and SIMATIC PCS 7 Asset Management)
Operating hours counter	(via SIMATIC PC DiagMonitor and SIMATIC PCS 7 Asset Management)
Displays	<ul style="list-style-type: none"> Two-digit 7-segment display for visualization of POST codes during BIOS booting Two programmable status LEDs

Safety

Protection class	Protection class I compliant with IEC 61140
Safety directives	EN 61131-2; UL508; CSA C22.2 No 142

Noise level

Operation	< 55 dB (A) to DIN 45635-1
-----------	----------------------------

Electromagnetic compatibility (EMC)

Emitted interference	EN 55022 Class B; EN 61000-3-2 Class D EN 61000-3-3; FCC Class A
Immunity to conducted interference on the supply lines	± 2 kV (to IEC 61000-4-4; burst) ± 1 kV (to IEC 61000-4-5; symmetrical surge) ± 2 kV (to IEC 61000-4-5; asymmetrical surge)
Immunity to interference on signal lines	± 1 kV (to IEC 61000-4-4; burst; length < 3 m) ± 2 kV (to IEC 61000-4-4; burst; length > 3 m) ± 2 kV (to IEC 61000-4-5; surge; length > 30 m)
Immunity to static discharge	± 6 kV contact discharge (to IEC 61000-4-2) ± 8 kV air discharge (to IEC 61000-4-2)
Immunity to high-frequency irradiation	10 V/m, 80 to 1000 MHz and 1.4 to 2 GHz, 80% AM (to IEC 61000-4-3) 1 V/m, 2 to 2.7 GHz, 80% AM (to IEC 61000-4-3) 10 V, 9 kHz to 80 MHz, 80% AM (to IEC 61000-4-6)
Immunity to magnetic fields	100 A/m, 50/60 Hz (to IEC 61000-4-8)

Technical specifications (cont.)

Climatic conditions

Temperature	Tested according to IEC 60068-2-1, IEC 60068-2-2, IEC 60068-2-14
• Operation	<ul style="list-style-type: none"> +5 ... +45 °C (with DVD writer, only up to +40 °C) +5 ... +50 °C (power of all slots max. 20 W) +5 ... +55 °C (power of all slots max. 10 W)
• Storage/transport	-20 ... +60 °C
• Gradient	Operation: max. 10 °C/h; storage: 20 °C/h, no condensation
Relative humidity	Tested according to IEC 60068-2-78, IEC 60068-2-30
• Operation	5 ... 80% at 25 °C (no condensation)
• Storage/transport	5 ... 95% at 25 °C (no condensation)

Mechanical environmental conditions

Vibrations	Tested according to IEC 60068-2-6
• Operation	10 to 58 Hz: 0.075 mm, 58 to 500 Hz: 9.8 m/s ² Limitation with DVD writer: 10 to 58 Hz: 0.019 mm / 58 to 500 Hz: 2.5 m/s ² Limitation with portrait assembly: 10 to 58 Hz: 0.0375 mm / 58 to 500 Hz: 4.9 m/s ²
• Storage/transport	5 ... 9 Hz: 3,5 mm, 9 to 500 Hz: 9.8 m/s ²
Shock	Tested according to IEC 60068-2-27, IEC 60068-2-29
• Operation	50 m/s ² , 30 ms Limitation with portrait assembly: 25 m/s ² , 30 ms
• Storage/transport	250 m/s ² , 6 ms

Approvals

CE living accommodation	
• Emitted interference	EN 61000-6-3: 2001
• Noise immunity	EN 61000-6-1: 2001
CE industrial environment	
• Emitted interference	EN 61000-6-4: 2001
• Noise immunity	EN 61000-6-2: 2005
cULus	UL 60950-1, Report E11 5352 and CAN/CSA-C22.2 No. 60950-1; UL508 and CAN/CSA-C22.2 No. 142

Power supply (electrically isolated)

Power supply	24 V DC (-15% / +20%), SELV
DC input current	Continuous current up to 8 A (up to 14 A for 30 s during startup)
Max. power consumption (at 24 V DC)	210 W

Dimensions and weights

Dimensions including DVD writer (W x H x D) in mm	297 x 267 x 100
Weight	Approx. 7 kg

Starter systems

SIMATIC PCS 7 BOX

SIMATIC PCS 7 BOX 416

3

Technical specifications (cont.)

Automation: WinAC Slot PLC module

CPU	WinAC Slot 416 V4.0 hardware controller for SIMATIC Box PC 627B with Windows XP Professional operating system
Main memory	1.6 + 1.6 MB (integrated)
Load memory	256 KB
Memory card	2 MB RAM (fitted)
Execution times	Binary command: 0.04 µs, IEEE floating-point: 0.12 µs
PROFIBUS DP	PROFIBUS DP and PROFIBUS DP/MPI interfaces onboard
Dimensions	PCI plug-in card (3/4 long)

All-in-one system

Preinstalled software/license	PCS 7 Engineering Software V7.0 for AS/OS
Number of process objects (AS/OS engineering and runtime)	250 POs (expandable per PowerPack to 2000 POs)

Runtime system

Preinstalled software/license	PCS 7 OS Software Single Station V7.0 and SIMATIC PCS 7 AS Runtime license
Number of process objects (runtime)	<ul style="list-style-type: none"> • 250 POs for OS (expandable per PowerPack to 2000 POs) • 250 POs for AS (expandable per AS Runtime license)

Selection and Ordering Data

Order No.

SIMATIC PCS 7 BOX 416 all-in-one system (ES, OS and AS)

assembled and preinstalled, comprising:

- SIMATIC Box PC 627B, 24 V DC, with WinAC Slot 416 V4.0, Windows XP Professional MUI operating system (German, English, French, Italian, Spanish) and DiagMonitor diagnostics software

- Memory card 2 MB
- Backup battery
- Mouse
- SIMATIC PCS 7 Engineering Software V7.0 for AS/OS including AS/OS Runtime license for productive operation, 250 POs, 5 languages (German, English, French, Italian, Spanish), floating license for 1 user

6ES7 650-2PA07-0YX0 D)

SIMATIC PCS 7 BOX 416 runtime system (OS and AS)

assembled and preinstalled, comprising:

- SIMATIC Box PC 627B, 24 V DC, with WinAC Slot 416 V4.0, Windows XP Professional MUI operating system (German, English, French, Italian, Spanish) and DiagMonitor diagnostics software
- Memory card 2 MB
- Backup battery
- Mouse
- SIMATIC PCS 7 OS Software Single Station V7.0, 250 POs, 5 languages (German, English, French, Italian, Spanish), single license for 1 installation
- SIMATIC PCS 7 AS Runtime license, 250 POs 5 languages (German, English, French, Italian, Spanish), single license for 1 installation

6ES7 650-2PB07-0YX0 D)

D) Subject to export regulations: AL: N, ECCN: 5D992B1

Starter systems

SIMATIC PCS 7 BOX

SIMATIC PCS 7 BOX 416

3

Selection and Ordering Data Order No.

Additional and expansion components

SIMATIC PCS 7 PowerPacks for all-in-one system

SIMATIC PCS 7 PowerPack Engineering Software AS/OS V7.0 for extending the engineering software for AS/OS

5 languages (German, English, French, Italian, Spanish), executes with Windows XP Professional, floating license for 1 user

Type of delivery: License key disk, emergency key disk, certificate of license, terms and conditions

- From 250 to 1000 POs, including AS/OS Runtime license
- From 1000 to 2000 POs, including AS/OS Runtime license

6ES7 658-5AB07-0YD5

6ES7 658-5AC07-0YD5

SIMATIC PCS 7 PowerPacks/licenses for runtime system

SIMATIC PCS 7 PowerPack OS Software Single Station V7.0 for extending the OS Software Single Station

5 languages (German, English, French, Italian, Spanish), executes with Windows XP Professional, single license for 1 installation

Type of delivery: License key disk, emergency key disk, certificate of license, terms and conditions

- From 250 POs to 1000 POs
- From 1000 POs to 2000 POs

6ES7 658-2AB07-0YD0

6ES7 658-2AC07-0YD0

SIMATIC PCS 7 AS Runtime license (can be added to existing licenses)

5 languages (German, English, French, Italian, Spanish), executes with Windows XP Professional, single license for 1 installation

Type of delivery: License key disk, certificate of license, terms and conditions

- 100 POs
- 1000 POs

6ES7 653-2BA00-0XB5

6ES7 653-2BB00-0XB5

Selection and Ordering Data Order No.

SIMATIC PDM PCS 7 V6.0

Complete package for integration into the engineering toolset of the SIMATIC PCS 7 engineering system

5 languages (German, English, French, Italian, Spanish), executes with Windows 2000 Professional or Windows XP Professional, floating license for 1 user, with:

- SIMATIC PDM Basic
- Option "Integration in STEP 7/PCS 7"
- Option "Routing through S7-400"
- Option "128 TAGs"

Software and electronic documentation on toolset DVD

Type of delivery:

- License key disk, emergency key disk, certificate of license, terms and conditions
- 2 CDs with SIMATIC PDM V6.0 and device library

Note: TAG options and PowerPacks: see page 4/14

6ES7 658-3LX06-0YA5

Further SIMATIC PCS 7 system software

- SIMATIC BATCH: see Section "Batch automation"
- SIMATIC PCS 7 asset-management: see Section "Asset management"

SIMATIC PC keyboard (USB connection)

- International key assignment

6ES7 648-0CB00-0YA0

Power supply 230 V AC / 24 V DC

- SITOP smart 240W
Stabilized load power supply, input: 120/230 V AC, output: 24 V DC / 10 A
- SITOP DC UPS module
24 V DC/15 A ¹⁾
with RS 232 interface and charger unit for 24 V lead battery
Input: 24 V DC/16 A, output 24 V DC/15 A
- SITOP battery module
24 V DC/20 A/7 Ah
for DC UPS module 15 A

6EP1 334-2AA01

6EP1 931-2EC31

6EP1 935-6ME21

¹⁾ Additive DC UPS software (executes with Windows NT, 2000 and XP) for further processing of the signals sent by the DC UPS module with RS 232 interface on the PC; freeware for downloading at <http://www.siemens.com/sitop>

Overview



SIMATIC PCS 7 OS Software Single Station
1000 POs

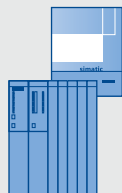

SIMATIC PCS 7 AS Runtime license
(cumulative),
1000 POs (AS 414-3, AS 416-2) or
400 POs (AS 417-4-1H)

AS 414-3 / AS 416-2 / AS 417-4-1H

- Runtime license for 100 POs
- UR2 rack
- Without power supply
- Without backup batteries
- Without memory card

Components of the Runtime Basic Package V7.0

The SIMATIC PCS 7 Runtime Basic Package V7.0 has been specially designed as a low-cost starter solution for process automation with SIMATIC PCS 7 automation systems of S7-400 design. The hardware and the system software of this product bundle are scalable, and can be expanded using other SIMATIC PCS 7 system components. The three versions differ with regards to the automation system used as platform: AS 414-3, AS 416-2 or AS 417-4-1H. They have a neutral design so that all options remain available for an individual system configuration.

Design

A SIMATIC PCS 7 Runtime Basic Package V7.0 comprises:

- One AS 414-3, AS 416-2 or AS 417-4-1H automation system with Runtime license for 100 POs as defined in the Chapter "Automation systems", in each case as follows:
 - UR2 rack (9 slots)
 - Without power supply, without backup batteries
 - Without memory card
- One cumulative SIMATIC PCS 7 AS Runtime license with 1000 POs (AS-414-3, AS 416-2) or 400 PO (AS 417-4-1H), single license for 1 installation
- One SIMATIC PCS 7 OS Software Single Station V7.0, 1000 POs, single license for 1 installation

Selection and Ordering Data

Order No.

SIMATIC PCS 7 Runtime Basic Package AS 414-3

comprising:

- 1 x AS 414-3 automation system with Runtime license for 100 POs (according to definition in Chapter "Standard automation systems")
 - UR2 rack (9 slots)
 - Without power supply, without backup batteries
 - Without memory card
- 1 x SIMATIC PCS 7 AS Runtime license, 1000 POs (cumulative), 6 languages (German, English, French, Italian, Spanish, Chinese), single license for 1 installation
- 1 x SIMATIC PCS 7 OS Software Single Station V7.0, 1000 POs, 6 languages (German, English, French, Italian, Spanish, Chinese), single license for 1 installation

6ES7 650-3XG07-0YX0 D)

SIMATIC PCS 7 Runtime Basic Package AS 416-2

comprising:

- 1 x AS 416-2 automation system with Runtime license for 100 POs (according to definition in Chapter "Standard automation systems")
 - UR2 rack (9 slots)
 - Without power supply, without backup batteries
 - Without memory card
- 1 x SIMATIC PCS 7 AS Runtime license, 1000 POs (cumulative), 6 languages (German, English, French, Italian, Spanish, Chinese), single license for 1 installation
- 1 x SIMATIC PCS 7 OS Software Single Station V7.0, 1000 POs, 6 languages (German, English, French, Italian, Spanish, Chinese), single license for 1 installation

6ES7 650-3XH07-0YX0 D)

D) Subject to export regulations: AL: N, ECCN: 5D992B1

Starter systems

Runtime Basic Packages

Selection and Ordering Data

Order No.

SIMATIC PCS 7 Runtime Basic Package AS 417-4-1H

6ES7 650-3XJ07-0YX0 D)

comprising:

- 1 x AS 417-4-1H automation system with Runtime license for 100 POs (according to definition in Chapter "Standard automation systems")
 - UR2 rack (9 slots)
 - Without power supply, without backup batteries
 - Without memory card
- 1 x SIMATIC PCS 7 AS Runtime license, 400 POs (cumulative), 6 languages (German, English, French, Italian, Spanish, Chinese), single license for 1 installation
- 1 x SIMATIC PCS 7 OS Software Single Station V7.0, 1000 POs, 6 languages (German, English, French, Italian, Spanish, Chinese), single license for 1 installation

D) Subject to export regulations: AL: N, ECCN: 5D992B1

3

Engineering system



4/2	Introduction
4/3	ES hardware
4/3	ES single station
4/4	ES software
4/4	Introduction
4/5	Standard engineering software
4/10	Version Cross Manager
4/11	Version Trail
4/12	Import/Export Assistant
4/13	SIMATIC PDM Process Device Manager
4/20	Engineering Process Safety
4/20	Introduction
4/22	Engineering F/FH systems
4/23	SIMATIC Safety Matrix
4/25	SIMATIC PCS 7 Safety ES Packages
4/26	Simulation
4/26	Simulation with S7-PLCSIM

Engineering system

Introduction

Overview

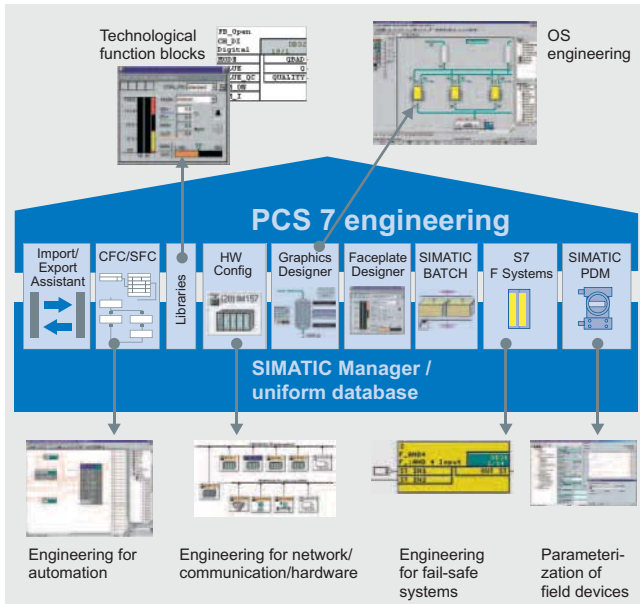

The engineering system of the SIMATIC PCS 7 process control system is based on powerful PC technology combined with the Windows XP Professional operating system. This can also be used in offices or industrial environments.

The engineering software executed on it can be optimally matched to different customer requirements and tasks.

In accordance with the application, the following system versions are defined by licensing of the standard engineering software:

- A classic, exclusive engineering station; not suitable for productive operation as an operator station
- A combined engineering/operator station for small applications; also suitable for productive operation as an operator station

The basic functionality covered by the standard engineering software can be optionally expanded depending on the project-specific task and its implementation.

Design

The control center of the engineering system is the SIMATIC Manager. It is the integration platform for the engineering toolset as well as the configuration basis for all engineering tasks of the SIMATIC PCS 7 process control system. All aspects of the SIMATIC PCS 7 project are created, managed, archived and documented here. A uniform database guarantees that once data have been entered they are available throughout the system.

The engineering toolset contains tools which are optimally matched to one another for system-wide project-oriented engineering, and which simultaneously provide the basis for asset management of the I&C equipment. These include tools for effective engineering of the following components:

- Control system hardware including distributed I/O and field devices
- Communication networks
- Automation functionality for continuous and batch processes (AS engineering)
- Operation and monitoring functionality (OS engineering)
- Safety applications (Safety Integrated for Process Automation)
- Diagnostics and asset management functionality
- Batch processes automated using SIMATIC BATCH
- Material transports controlled using SIMATIC Route Control
- Cooperation with higher-level CAD/CAE planning tools (importing and exporting of tags and example solutions)

Technologists as well as process and production engineers can carry out planning and configuration in their acquainted environments when using this range of tools as well as predefined blocks (tag types) and plans (example solutions).

Overview



Just like the single-user system of the operator system, the central engineering system of the SIMATIC PCS 7 process control system is based on the single station version of a SIMATIC PCS 7 industrial workstation. This is characterized by powerful PC technology combined with the Windows XP Professional operating system. It can be used in offices or industrial environments.

One process monitor can be connected to the integral graphics interface. Increased user-friendliness can be achieved by connecting up to 4 process monitors using a special multi-VGA graphics card.

Design

The hardware platform for the engineering system of the SIMATIC PCS 7 process control system is the SIMATIC PCS 7 Industrial Workstation of single station design. This is based on the SIMATIC Rack PC 547B and is already prepared for installation in 19" rack systems.

The SIMATIC PCS 7 Industrial Workstation of single station design is available in two versions which differ in their communications interface to the Industrial Ethernet plant bus:

- **SIMATIC PCS 7 ES/OS RACK PC 547B BCE WXP**
FastEthernet connection to plant bus with 10/100/1000 Mbit/s RJ45 network card and Basic Communication Ethernet (BCE) for communication with up to 8 automation systems (not fault-tolerant)
- **SIMATIC PCS 7 ES/OS RACK PC 547B IE WXP**
FastEthernet connection to plant bus with CP 1613 communications processor (without limitations)

The CP 1613 communication integrated in the IE version SIMATIC PCS 7 ES/OS RACK PC 547B IE WXP is a combination of CP 1613 communications processor and S7-1613 communications software. When using fault-tolerant automation systems, the ES/OS single station requires the S7-REDCONNECT software instead of the S7-1613 communications software. The S7-REDCONNECT Upgrade is suitable for upgrading the communications software (for ordering data, see page 9/29).

The Windows XP Professional operating system and the SIMATIC PCS 7 engineering software for AS/OS are preinstalled on the SIMATIC PCS 7 Industrial Workstation on delivery. The scope of performance of the preinstalled SIMATIC PCS 7 engineering software is defined by installation of the purchased software licenses.

A 10/100/1000 Mbit/s Ethernet RJ45 port is already onboard and can be used for connecting to an OS LAN (terminal bus).

The scope of delivery also includes a mouse. The keyboard and monitor must be ordered separately (see page 2/15 and 2/17).

Options/expansions

A multi-VGA card can be added to the engineering system. 2 or 4 monitors can then be connected per station (see Section "SIMATIC PCS 7 Industrial Workstation" in Chapter "System-neutral components").

Technical specifications

Detailed technical data of the single station version of the SIMATIC PCS 7 Industrial Workstation can be found at page 2/12 in tabular format.

Selection and Ordering Data Order No.

Single station

Windows XP Professional MUI operating system (German, English, French, Italian, Spanish, Chinese)

- **SIMATIC PCS 7 ES/OS 547B BCE WXP**

Connection to plant bus with Ethernet network card RJ45 (PCI) 10/100/1000 Mbit/s and Basic Communication Ethernet (BCE) for up to 8 automation systems (not H-systems)

6ES7 650-0NF07-0YX0 D)

- **SIMATIC PCS 7 ES/OS 547B IE WXP**

Connection to plant bus with CP 1613 A2 communications processor

6ES7 650-0NF07-0YX1 D)

Additional and expansion components

SIMATIC NET S7-REDCONNECT Upgrade

for communication with fault-tolerant AS systems, see page 9/28

Further additional and expansion components can be found at page 2/15

D) Subject to export regulations: AL: N, ECCN: 5D992B1

Note:

Ordering data in abbreviated form; for detailed Ordering data, see page 2/14

Engineering system

ES software

Introduction

Overview

The functionality of the engineering system is largely covered by the standard engineering software. The following software options are available in addition for special functions:

- SIMATIC PCS 7 Import/Export Assistant
- SIMATIC Version Cross Manager
- SIMATIC Version Trail
- Engineering Process Safety for safety applications based on Safety Integrated for Process Automation
- SIMATIC PCS 7 Asset Engineering
- SIMATIC Route Control Engineering
- SIMATIC PDM Process Device Manager for SIMATIC PCS 7
- S7-PLCSIM for the functional testing of CFC/SFC programs

Design

SIMATIC PCS 7 engineering system with Windows XP Professional operating system

Versions	Classic, exclusively engineering station	Combined engineering/operator station for small applications
Can be used as operator station for productive operation	No	Yes

[SIMATIC PCS 7 Industrial Workstation including operating system, alternatives](#)

BCE communication for up to 8 automation systems (not H systems)	SIMATIC PCS 7 ES/OS 547B BCE WXP
Communication IE	SIMATIC PCS 7 ES/OS 547B IE WXP

[Additional IE communications software for SIMATIC PCS 7 ES/OS 547B IE WXP](#)

Software for IE communication with fault-tolerant automation systems (additive to S7-1613)	SIMATIC NET S7-REDCONNECT/2006 Upgrade
--	--

[Standard engineering software, alternatives](#)

SIMATIC PCS 7 Engineering Software V7.0, without OS Runtime license for productive operation	AS and OS, including 2-hour OS test operation	●	
	OS, including 2-hour OS test operation	●	
	AS	●	
SIMATIC PCS 7 Engineering Software V7.0, with OS Runtime license for productive operation	AS and OS		●

[Supplementary engineering software \(optional\)](#)

Import/Export Assistant V7.0		●	
Version Cross Manager V7.0		●	
Engineering Process Safety	S7 F Systems V6.0	●	
	Safety Matrix Tool	●	
PCS 7 Asset Engineering V7.0		●	
SIMATIC Route Control Engineering V7.0		●	
SIMATIC PDM PCS 7 V6.0		●	
Simulation with S7-PLCSIM V5.4		●	

Available hardware and software components of the engineering system, as well as possible configurations

[Note on Microsoft SQL Server software](#)

The "SQL Server" software from Microsoft delivered with SIMATIC PCS 7 may not be used outside the SIMATIC PCS 7 environment without the written approval of Siemens.

Overview

The standard engineering software provides the basic functionality for configuration of SIMATIC PCS 7 plants with:

- Automation systems
- Process I/O
- Communication networks
- Operator systems
- Maintenance station
- SIMATIC BATCH
- SIMATIC Route Control

Licensing of the standard engineering software depends on use of the engineering station as:

- Classic, exclusive engineering station (not suitable for productive operation as an operator station)
- Combined engineering/operator station for small applications (suitable for productive operation as an operator station)

Classic, exclusive engineering station with unlimited number of process objects (POs)

Three software versions with unlimited POs are available for the classic engineering station:

- AS/OS - for engineering of automation systems (AS) and operator systems (OS)
- OS - only for OS engineering
- AS - only for AS engineering

With the OS and AS/OS software versions, the OS configuration can be tested in an OS test mode limited to 2 hours. This OS test mode is not suitable for productive operation. After 2 hours, the engineering station automatically switches to demonstration mode.

The AS/OS software version is additionally upgraded by adding an AS runtime license for 600 POs.

By means of a [Rental License](#) limited to 30 days for AS engineering or OS engineering (unlimited POs in each case), a cost-effective alternative is offered for short-term projects or short-term capacity bottlenecks.

Combined engineering/operator station for small applications (scalable POs)

To support compact process control plants, an ES/OS software combination of limited volume is offered with 250, 1,000 or 2,000 POs. In addition to the engineering licenses, these "All-in-one Licenses" also contain runtime licenses for AS and OS with the corresponding volumes.

PowerPacks enable further expansion of the volume:

- From 250 POs to 1,000 POs
- From 1,000 to 2,000 POs (in each case including AS/OS runtime license)
- From 2,000 POs to unlimited POs (only with OS runtime license)

Function

Essential tools of the standard engineering software and their functions:

SIMATIC Logon

Together with the versatile recording facilities provided by the modification logbook, SIMATIC Logon, the user administration and access control function used in the engineering system, offers plant owners exceptional system support when complying with FDA requirements.

Using SIMATIC Logon, the administrator can assign specific access privileges to groups of users, thus controlling the possibilities for data access. Operator interventions in the engineering system as well as all online modifications which affect the automation systems, operator systems, SIMATIC BATCH or SIMATIC Route Control can be recorded in the modification reports.

If the modification reports are linked to the data of SIMATIC Logon during evaluation, it can be clearly proven who has carried out a specific modification and at what time.

SIMATIC Manager

The SIMATIC Manager is the control center for engineering of the SIMATIC PCS 7 process control system. All aspects of the SIMATIC PCS 7 project are created, managed, archived and documented here. The tools for engineering of the hardware components, communication and application software are also called from here.

The hardware required for use in a SIMATIC project, such as automation systems, communications components and process I/O, is stored in an electronic catalog. The hardware is configured and parameterized using the HW-Config tool.

To create the automation logic, standardized function blocks are combined with one another in the graphic configuration tool CFC according to technological specifications. Predefined blocks (process tag types) or charts (example solutions) can be used for this purpose simply by selecting them from a catalog and then positioning, graphically interconnecting and parameterizing them in the working area. No detailed programming knowledge is required, one can completely concentrate on the technological aspects of configuration. The process tag data relevant to operation and monitoring, such as messages and variables, are generated at the same time as configuration of the automation functions.

Sequential controls permit control and selective processing of the basic automation functions created per CFC by means of changes in operating mode and status. Powerful test and commissioning functions for the graphic configuration and commissioning of sequential controls are offered by the SFC editor.

Complete SIMATIC PCS 7 projects or all project modifications can be compiled in one working step and downloaded to the target systems involved, e.g. automation systems, operator system or SIMATIC BATCH. The engineering system automatically ensures that the sequence is correct. The procedure is displayed and controlled in a central dialog.

Selective configuration modifications can be downloaded online to the corresponding target systems. Short turnaround times result in short waiting times for the commissioning engineer, and have a favorable effect on the commissioning costs. Program modifications relevant to automation systems can be initially debugged in a test system prior to downloading to the target system of the running plant.

Engineering system

ES software

Standard engineering software

Multi-project engineering

Multi-project engineering permits division of a large complex project into several subprojects in accordance with technological criteria in order to allow several teams to work on the project in parallel. To achieve this, a host "Multi-project" is defined in the SIMATIC Manager. Individual (sub)projects can be inserted into or removed from a multi-project at any time. Similarly, projects can be divided or combined (Branch & Merge).

Central configuration functions for multi-projects help to reduce the configuration overhead. For example, a hierarchy folder can be created in the current project and also automatically in all other projects. It cannot be modified there, but objects can be inserted. All block types used in a multi-project can also be updated centrally.

The (sub)projects belonging to a multi-project are saved on a central server and can be sent to local engineering stations for editing. The engineering performance is then not affected by network access.

Concurrent engineering

In the case of concurrent engineering, several configuration engineers can work in CFC and SFC simultaneously on a project without this having to be first divided into subprojects. The project is located on one of the engineering stations involved. This requires connections to the OS LAN (terminal bus) and plant bus in order to download the configuration data to the target systems.

The engineering stations working as "project clients" can access the project data via the OS LAN (terminal bus) or a different LAN/WAN. A CFC can be opened and viewed simultaneously by several configuration engineers. However, simultaneous write operations to the database are rejected by the system.

It is then possible, for example, to use charts in online (debugging) mode during commissioning while carrying out modifications to the project at the same time.

Branch & Merge

Branch & Merge supports the division and combination of projects from the technological viewpoint.

Charts or plant units can be copied into another project and edited there. Interconnections which are not specific to a project, typically for interlocking, become text interconnections. When merging, charts with the same name are overwritten in the original object, and text interconnections – even those which you have entered yourself – can be closed by pressing a button.

Project views

The SIMATIC Manager supports the various tasks for creating a plant project by means of the following project views:

- **Component view (HW-Config)**
for configuration of hardware such as automation systems, bus components or process I/O

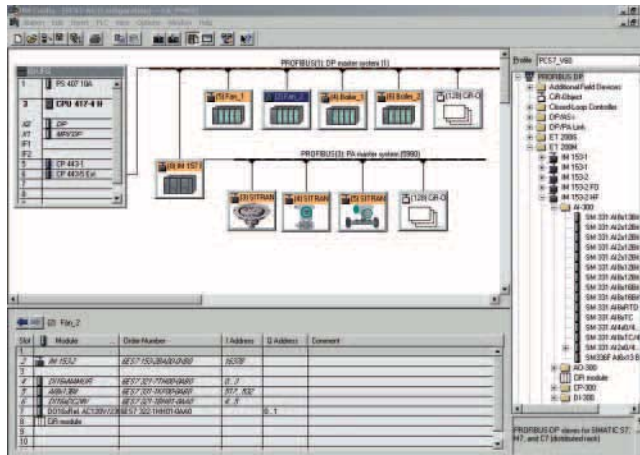

Component view: hardware configuration in the SIMATIC Manager with HW-Config

- **Process object view**
as the central development environment for all aspects of process tags/objects

The process object view of the SIMATIC Manager supports the work of a process engineer by providing a universal view of the process tag. It shows the technological hierarchy of the plant (presented in tree form) in combination with a tabular view of all aspects of the process tag/object (general data, parameters, signals, messages, image objects and measured value archives). This provides the technologist with fast orientation.

All objects in the marked branch of the hierarchy are displayed in the table so that they can be directly processed with user-friendly edit, filter, replace, import and export functions. A special test mode offers the facility for testing process tags and CFCs online and for starting them up.

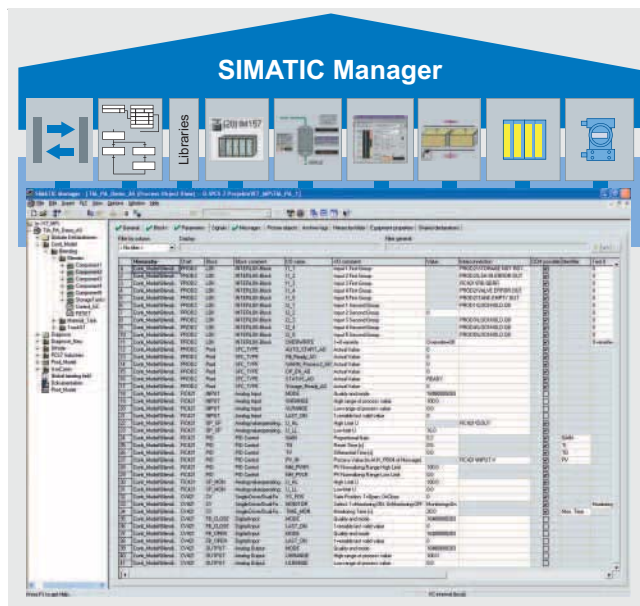

Process object view

The OS areas and the image hierarchy for process control, as well as the SIMATIC PCS 7 asset management, can be derived from the technological hierarchy. Furthermore, it also forms the basis for the plant-oriented identification of process objects.

Common displays can be positioned in pictures by means of the image hierarchy, and automatically linked to subordinate images. The configuration engineer is only responsible for the correct positioning. Since the number of common display fields and their semantics can be configured, it is also possible to implement customized alarm configurations.

Using the process object view, "Smart Alarm Hiding" can also be configured. This function is understood as the dynamic hiding of messages (alarms) of the technological blocks grouped in a plant unit which are of secondary importance depending on the operating state of this unit (startup, service, etc.). Alarms can be displayed or hidden separately for each of the maximum 32 operating states through selection of option boxes in the alarm matrix of the process object view. Although hidden alarms are not signaled visually and audibly, they are still logged and archived as before.

Continuous function chart (CFC)

The CFC editor is the tool for graphical configuration and commissioning of continuous automation functions. Preengineered function blocks can be positioned, configured and interconnected within CFCs with the support of powerful autorouting and integral configuration of HMI messages. Special configuration techniques such as chart-in-chart for implementing hierarchical plans or the multiple usage of chart block types (chart compiled as block type) or SFC types (standardized sequential controls) in the form of instances offer an additional rationalization potential.

When creating a new CFC, a new runtime group with the same name as the chart is created. All the blocks that are subsequently entered in the chart are automatically added to this runtime group. Each block is therefore already assigned runtime properties when inserting, and these properties can be optimized by means of modifications in the runtime editor or by using algorithms.

The algorithm first determines the optimum block sequence separately for each runtime group, and then the optimum sequence of runtime groups.

In addition to convenient editing functions, the scope of CFC functions also includes powerful test and commissioning functions as well as individually configurable documentation functions.

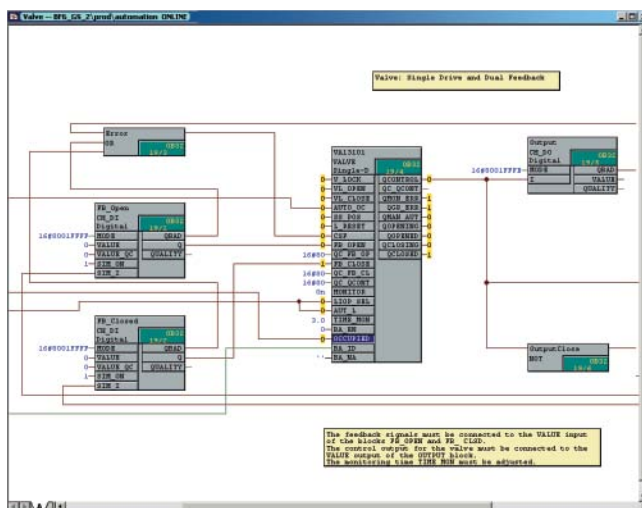

Continuous function chart

Sequential function chart (SFC)

The SFC editor is used for the graphical configuration and commissioning of sequential controls for batch production operations. It possesses convenient editing functions as well as powerful test and commissioning functions.

Using a sequential control, basic automation functions usually created using CFC are controlled and selectively processed by means of changes in operating mode and status. Depending on the subsequent use, the sequential controls can be created either as a SFC plan or SFC type.

SFC plan

The SFC plan can be used to implement sequential controls which can be applied once and which access several partial areas of the production plant. Each SFC plan contains standardized inputs and outputs for status information and for control by the user program or the user. The SFC plan can be positioned and linked as a block in the CFC. The required CFC block connections are selected by simple operations and connected to the steps or transitions of the step chains. An ISA 88-conform status manager enables the configuration of up to 8 separate sequence chains within a single SFC, e.g. for states such as HOLDING or ABORTING, for SAFE STATE or for different operating modes.

SFC type

SFC types are standardized sequential controls which can be applied repeatedly and which access one partial area of the production plant. They can be organized in libraries, and handled like normal function blocks, i.e. they can be selected from a catalog and positioned, interconnected and parameterized as an instance in a CFC plan.

Changes to the original automatically result in corresponding changes in all instances. An SFC type may contain up to 32 sequences. Using the function "Create/update block symbols", a block symbol is automatically positioned and interconnected in the associated process display for all SFC instances with HMI features.

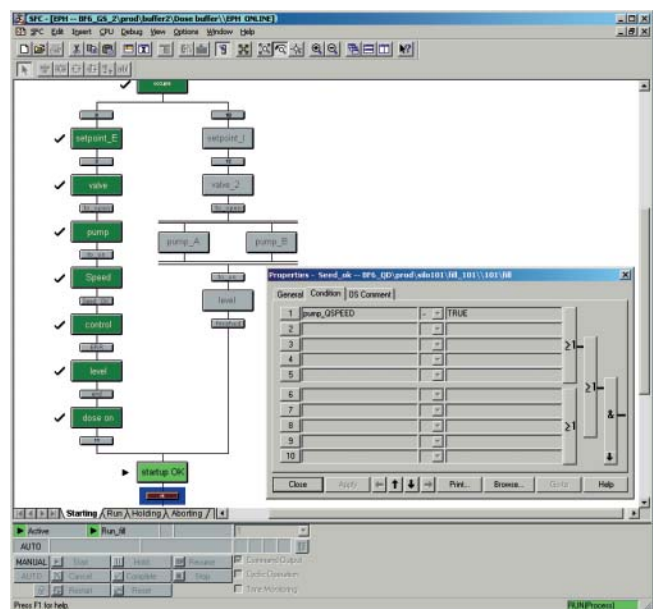

Sequential function chart

Engineering system

ES software

Standard engineering software

I&C libraries

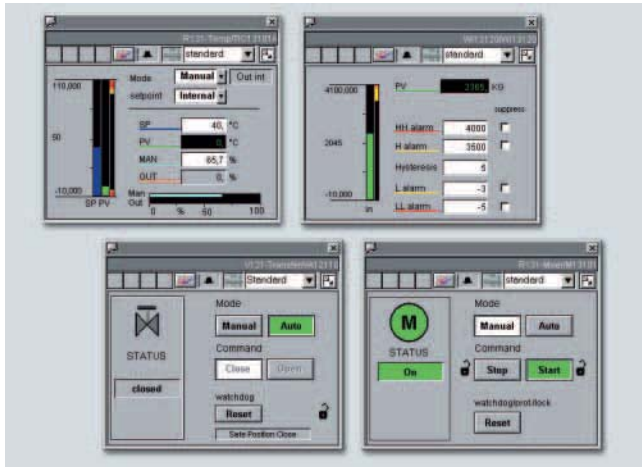

Examples of editable OS standard displays (faceplates) from the PCS 7 library

Preconfigured and tested blocks, faceplates and symbols are organized in I&C libraries and form the basic elements for the graphic configuration of automation solutions. The use of these library elements plays a major role in minimizing the engineering input and project costs.

The comprehensive range of blocks can be categorized as follows:

- Simple logic and driver blocks
- Technological blocks with integral operation and signaling functions such as PID controllers, motors or valves
- Blocks for integration of PROFIBUS field devices in accordance with PROFIBUS PA profile 3.0 (including standardized evaluation of the process value status)
- Blocks with more advanced control algorithms for Advanced Process Control (APC) functions

Advanced Process Control (APC) functions

The APC functions concentrated in separate blocks expand the PID-based control functions of SIMATIC PCS 7 by more advanced control algorithms, e.g.:

- Model-based multi-variable controller

The use of a multi-variable controller is recommendable for complex processes where several variables which are mutually dependent have to be controlled. Separate control of the individual variables, e.g. using PID controllers, has the disadvantages that interactions result in different effects on the respective variables.

The model-based ModPreCon multi-variable controller integrated in SIMATIC PCS 7 separately analyzes the response of up to four mutually dependent variables over a longer period of time. A parameter matrix is calculated from the results, and used by the ModPreCon for optimum control of the variables.

Note:

The ModPreCon makes great demands on memory and processing time of the designated automation system. For that reason, please check the resources of the designated automation system before use. We recommend the use of an automation system of type AS 416 or higher.

- Setting of control parameters dependent on working point

The GainSched block has been designed for variable setting of controller parameters depending on the working point in non-linear controlled systems. The block functions similar to the polygon block, and can derive three separate output variables from the response of an input variable, and apply these as control parameters for a linked controller block. The GainSched block then adjusts the control parameters of the combined controller depending on the response of the actual value.

The faceplate of the GainSched block can be called from the faceplate of the associated controller.

- Monitoring of control quality

The ConPerMon block can be used to monitor the quality of a controller block according to a patented procedure. The setpoint, actual value and manipulated variable of the controller block (e.g. PID controller) are connected to the ConPerMon block which determines the control quality using these online values. The block can trigger a warning or alarm depending on the deviation from a reference value, e.g. the control quality determined during commissioning.

The faceplate of the ConPerMon block can be called from the faceplate of the associated controller. OS displays can be generated during engineering which list all deviations in the control quality of a plant or unit. The plant operator can use these displays to recognize problems early, and to analyze and specifically eliminate such before they result in serious deficiencies or a production failure.

PID Tuner

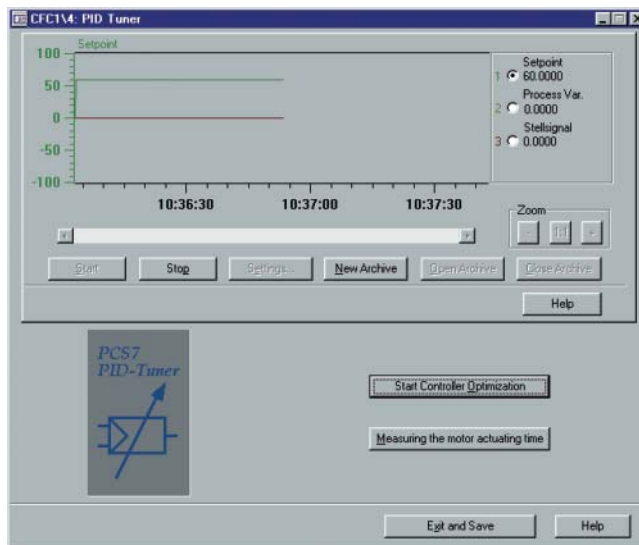

The PID Tuner is a function integrated in the CFC for optimization of the CTRL_PID and CTRL_S software controllers. The optimum parameters for a control loop can then be determined for PID, PI and P control modes in defined steps.

The tool is suitable for optimizing controlled systems with or without an integral component. Optimization can be carried out in manual or automatic mode. The transient response of the controllers with the determined parameters can be checked by defining jumps. The controller parameters can be saved, and recalled as required.

During determination of the controller parameters, the typical controller values (actual value, setpoint, manipulated variable) are recorded by a trend function.

Graphics designer and faceplate designer

The project data for the engineering of the operator systems are organized with the SIMATIC Manager. All the data relevant to operation and monitoring of a process tag, such as messages and HMI variables, are generated automatically during definition of the automation function. A powerful graphics designer is available for the generation of process displays.

In addition to the standard faceplates, the faceplate designer is used to simply generate customized faceplates for operation and monitoring of process tags or plant components. Block symbols can be conveniently interconnected to process tags using Drag & Drop.

DOCPRO

DOCPRO is a tool for effective generation and management of plant documentation in accordance with defined standards. DOCPRO permits you to structure your project data in any manner, to process them in the form of standardized circuit manuals, and to print them in a uniform layout. You can incorporate your own cover sheets, layouts, graphics, logos or title block data. It is easy to control printing, i.e. you can specifically output individual parts of the project or all project data on the printer.

Selection and Ordering Data	Order No.
-----------------------------	-----------

A classic, exclusive engineering station without limitation of quantities, not suitable for productive operation as an operator station

SIMATIC PCS 7 Engineering Software V7.0

6 languages (German, English, French, Italian, Spanish, Chinese), executes with Windows XP Professional, floating license for 1 user

Electronic documentation on PCS 7 toolset DVD

Type of delivery:
License key disk, emergency key disk, certificate of license, terms and conditions;
PCS 7 V7.0 toolset DVDs, Microsoft SQL Server 2005 including EULA and supplementary CDs/DVDs (e.g. Microsoft ServicePacks and tools)

AS/OS engineering software, enabled for two-hour OS test operation

- Unlimited POs, including AS Runtime license for 600 POs

6ES7 658-5AF07-0YA5

OS engineering software, enabled for two-hour OS test operation

- Unlimited POs

6ES7 658-2DF07-0YA5

AS engineering software

- Unlimited POs

6ES7 658-1AF07-0YA5

Selection and Ordering Data	Order No.
-----------------------------	-----------

SIMATIC PCS 7 Engineering Software V7.0 Rental License

6 languages (German, English, French, Italian, Spanish, Chinese), executes with Windows XP Professional

Rental license for 30 days

Type of delivery:
License key disk, certificate of license, terms and conditions;
PCS 7 V7.0 toolset DVDs, Microsoft SQL Server 2005 including EULA and supplementary CDs/DVDs (e.g. Microsoft ServicePacks and tools)

- For AS, unlimited POs

6ES7 658-1AF07-0YA6 C)

- For OS, unlimited POs

6ES7 658-2DF07-0YA6 C)

A combined engineering/operator station for small applications, suitable for productive operation as an operator station

SIMATIC PCS 7 Engineering Software V7.0

6 languages (German, English, French, Italian, Spanish, Chinese), executes with Windows XP Professional, floating license for 1 user

Electronic documentation on PCS 7 toolset DVD

Type of delivery:
License key disk, emergency key disk, certificate of license, terms and conditions;
PCS 7 V7.0 toolset DVDs, Microsoft SQL Server 2005 including EULA and supplementary CDs/DVDs (e.g. Microsoft ServicePacks and tools)

AS/OS engineering software, including AS/OS Runtime license for productive operation

- 250 POs

6ES7 658-5AA07-0YA5

- 1000 POs

6ES7 658-5AB07-0YA5

- 2000 POs

6ES7 658-5AC07-0YA5

SIMATIC PCS 7 Engineering PowerPack AS/OS V7.0

for extending the engineering software for AS/OS of a combined ES/OS station

6 languages (German, English, French, Italian, Spanish, Chinese), executes with Windows XP Professional, floating license for 1 user

Type of delivery:
License key disk, emergency key disk, certificate of license, terms and conditions

- From 250 to 1000 POs, including AS/OS Runtime license

6ES7 658-5AB07-0YD5

- From 1000 to 2000 POs, including AS/OS Runtime license

6ES7 658-5AC07-0YD5

- From 2000 to unlimited POs, including OS Runtime license

6ES7 658-5AF07-0YD5

C) Subject to export regulations: AL: N, ECCN: EAR99S

Engineering system ES software

Version Cross Manager

4

Overview

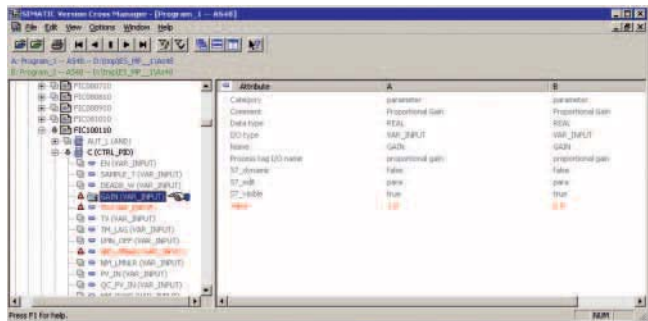

The SIMATIC Version Cross Manager is a user-friendly tool for determining the differences between various versions of individual projects or multi-projects by:

- Tracing missing, additional or differing objects by comparing hardware configuration, communication, technological hierarchy, CFC/SFC plans, SFC details, block types, alarms, global variables, signals and run sequences
- Graphic display of comparison results in a combination of tree and tabular formats
- Clear hierarchical structuring according to the technological hierarchy of the plant
- Color-coded identification of the differences

Function

Data exchange with planning tools

Using the SIMATIC Version Cross Manager you can also exchange data with planning tools (CAx data). It supports the following exchange functions:

- Export of CAx-relevant data, e.g. global declarations, technological hierarchy or measuring points
- Export of files in SIMATIC XML format (SML)
- Import of CAx data present in SIMATIC XML format

```
<?xml version="1.0" encoding="UTF-8" standalone="no" ?>
<Document url="http://www.siemens.com/automation/2005/SimaticML">
  <DocumentInfo FormatVersion="2.0" Tool="VXM" UserName="auhelmut" Created="2007-06-19T13:26:14" />
  <Project Name="TIA_PA_Demo_08" ID="000011200100000039-00000000-00000000" Version="V3.0" ExportScope="e1">
    <AppId AppName="SIMATIC" Value="000011200100000039-00000000-00000000" />
    <AttributeList>
      <Author />
      <Comment />
    </AttributeList>
    <ObjectList>
      <EnumerationType Name="Globale Deklarationen" ID="DT0004005B10000002" Version="V7.0">
        <AppId AppName="SIMATIC" Value="DT0004005B10000002" />
        <AttributeList>
          <Author />
          <Comment />
        </AttributeList>
      </EnumerationType>
      <EnumerationType Name="Aufzählungen" ID="DT0004005D10000004" Version="V7.0">
        <AppId AppName="SIMATIC" Value="DT0004005D10000004" />
        <AttributeList>
          <Author />
          <Comment />
          <VersionObj/Version>
            <VersionObj/Version>
          </AttributeList>
        </ObjectList>
      </EnumerationType>
      <EnumerationValue Name="Emergency_stop" ID="DT0004005F10000022">
        <AppId AppName="SIMATIC" Value="DT0004005F10000022" />
        <AttributeList>
          <Comment />
          <ValueS/Value>
        </AttributeList>
        <ObjectList />
      </EnumerationValue>
      <EnumerationValue Name="Maintenance" ID="DT0004005F1000001F">
        <AppId AppName="SIMATIC" Value="DT0004005F1000001F" />
        <AttributeList>
          <Comment />
          <ValueS/Value>
        </AttributeList>
        <ObjectList />
      </EnumerationValue>
    </ObjectList>
  </Project>
</Document>
```

Example of an XML export

Selection and Ordering Data

Order No.

For SIMATIC PCS 7 applications

SIMATIC Version Cross Manager V7.0
6 languages (German, English, French, Italian, Spanish, Chinese), executes with Windows XP Professional or Windows Server 2003, floating license for 1 user
Type of delivery: License key disk, emergency key disk, certificate of license, terms and conditions as well as TIA toolset CD V7.0

6ES7 658-1CX07-2YA5

For TIA applications

SIMATIC Version Cross Manager V7.0
6 languages (German, English, French, Spanish, Italian, Chinese), executes with Windows 2000 Professional, Windows XP Professional or Windows Server 2003, floating license for 1 user
Type of delivery: License key disk, emergency key disk, certificate of license, terms and conditions as well as TIA toolset CD V7.0

6ES7 658-1CX07-2YA5

SIMATIC Version Cross Manager Upgrade V7.0 for upgrading from Version Cross Checker V6.0/V6.1 to Version Cross Manager V7.0
6 languages (German, English, French, Spanish, Italian, Chinese), executes with Windows 2000 Professional, Windows XP Professional or Windows Server 2003, floating license for 1 user
Type of delivery: License key disk, emergency key disk, certificate of license, terms and conditions as well as TIA toolset CD V7.0

6ES7 658-1CX07-2YE5

The SIMATIC Version Cross Manager is a SIMATIC product which was developed for the SIMATIC PCS 7 process control system but which can also be used together with other SIMATIC products in the context of Totally Integrated Automation (TIA). In the case of products which can be used in both the SIMATIC PCS 7 and TIA environments, the ordering data and type of delivery may differ depending on the application. To provide a better overview and to avoid faulty ordering, the selection and ordering data of such products are therefore listed separately depending on the target application.

More information

Upgrade

SIMATIC PCS 7 engineering systems with Engineering Software V6.0 or V6.1 can be upgraded to Version 7.0 using the SIMATIC PCS 7 Engineering Upgrade Package. This upgrade package also includes the upgrade from SIMATIC Version Cross Checker V6.0/V6.1 to SIMATIC Version Cross Manager V7.0.

For applications outside SIMATIC PCS 7, a separate SIMATIC Upgrade Version Cross Manager V7.0 can be obtained for upgrading the SIMATIC Version Cross Checkers V6.0/V6.1.

For further information, see Chapter "Update/upgrade packages".

Overview

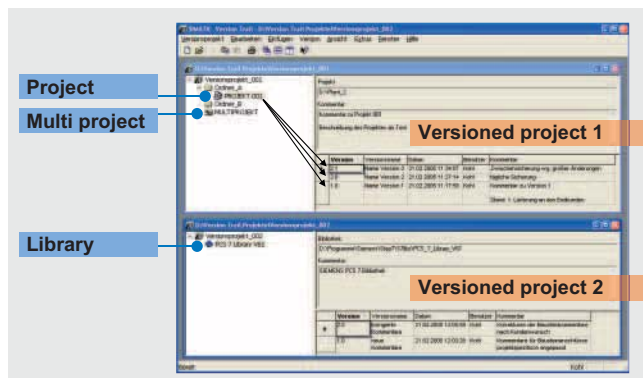

SIMATIC Version Trail is a software option for engineering which, together with the SIMATIC Logon central user administration, can assign a version history to libraries, projects and multi-projects. It can be used within SIMATIC PCS 7 or also in the context of Totally Integrated Automation with SIMATIC.

Function

When archiving, SIMATIC Version Trail in association with SIMATIC Logon creates a version history with the following information:

- Version
- Version name
- Date and time
- User
- Comment

This version history can be displayed and printed. Individual version releases can be dearchived from the version history and used further. SIMATIC Logon organizes the access protection.

Selection and Ordering Data

Order No.

For SIMATIC PCS 7 applications

SIMATIC Version Trail V7.0

6 languages (German, English, French, Italian, Spanish, Chinese), executes with Windows XP Professional or Windows Server 2003, floating license for 1 user

Type of delivery: License key disk, emergency key disk, certificate of license, terms and conditions as well as TIA toolset CD V7.0

6ES7 658-1FX07-2YA5

For TIA applications

SIMATIC Version Trail V7.0

6 languages (German, English, French, Spanish, Italian, Chinese), executes with Windows 2000 Professional, Windows XP Professional or Windows Server 2003, floating license for 1 user

Type of delivery: License key disk, emergency key disk, certificate of license, terms and conditions as well as TIA toolset CD V7.0

6ES7 658-1FX07-2YA5

SIMATIC Version Trail Upgrade V7.0

6 languages (German, English, French, Spanish, Italian, Chinese), executes with Windows 2000 Professional, Windows XP Professional or Windows Server 2003, floating license for 1 user

Type of delivery: License key disk, emergency key disk, certificate of license, terms and conditions as well as TIA toolset CD V7.0

6ES7 658-1FX07-2YE5

The SIMATIC Version Trail is a SIMATIC product which was developed for the SIMATIC PCS 7 process control system but which can also be used together with other SIMATIC products in the context of Totally Integrated Automation (TIA). In the case of products which can be used in both the SIMATIC PCS 7 and TIA environments, the ordering data and type of delivery may differ depending on the application. To provide a better overview and to avoid faulty ordering, the selection and ordering data of such products are therefore listed separately depending on the target application.

More information

Upgrade

SIMATIC PCS 7 engineering systems with Engineering Software V6.0 or V6.1 can be upgraded to Version 7.0 using the SIMATIC PCS 7 Engineering Upgrade Package. A component of this upgrade package is also the upgrade for SIMATIC Version Trail from V6.1 to V7.0.

For applications outside SIMATIC PCS 7, a separate SIMATIC Upgrade Version Trail V7.0 can be obtained for upgrading SIMATIC Version Trail V6.1.

For further information, see Chapter "Update/upgrade packages".

Note:

Please note that Version Trail cannot be used on its own, but only in combination with SIMATIC Logon (see page 2/4).

Engineering system

ES software

Import/Export Assistant

Overview

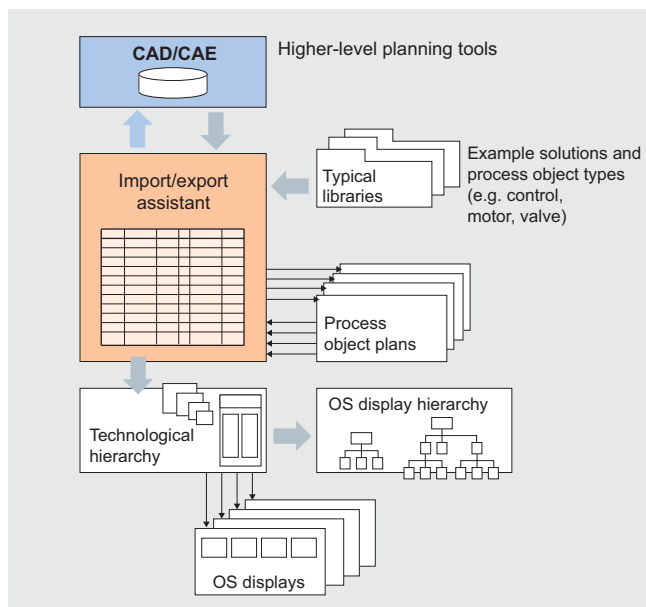

Efficient processing of mass data

The import/export assistant (IEA) is an effective tool for rational engineering of mass data, and is based on multiple use of process tag types and example solutions. It is particularly suitable for large plants with many process tags of the same type or with several plant components of the same type. Plant data which have already been configured (such as process tag lists or charts from the CAD/CAE world) can be imported into the engineering system and used for largely automatic generation of process tags. The data of the host planning system can be subsequently matched again with the parameters optimized during commissioning.

To permit simple and fast modification, the PCS 7 projects can also be exported, the data processed using the IEA editor or other programs (e.g. Microsoft Excel or Access), and subsequently reimported.

Benefits

The import/export assistant offers the following benefits when using previously configured plant data:

- Importing of previously configured plant data from the host CAD/CAE world, such as process tag list
 - No multiple inputs with the associated input errors
 - Simple handling, easy-to-use graphic environment
- Automatic and reproducible generation of process tags and derivatives based on the imported process tag lists and example solutions (technological hierarchy, charts of the individual process tags)
 - Drastic reduction in time required, and avoidance of errors
- Automatic derivation of the OS display hierarchy, automatic interconnecting of blocks and positioning in displays
 - Considerable reduction in time required and costs
- Commissioning of individual process tags with the user-friendly CFC and SFC graphic tools
- Exporting of parameters optimized during commissioning back to the CAD/CAE world
 - Consistent data in the host planning tools

Function

- Generation/modification of process tag types or example solutions
- Importing of data from plant planning
 - Generation of process tags from process tag types and derivatives from example solutions; provision with data from the import file (one process tag/derivative per import file line in each case)
 - Assignment of an import file to a process tag type, and checking of the assignment
 - Generation of a template for an input file for the process tag
- Exporting of data for plant planning
 - Generation of an export file per process tag type/example solution in each case, with one line for each process tag of this type or each derivative of this example solution
- Matching of process tags
 - Removal of parameter/signal connection points not present on the process tag type and of messages from the process tags
 - Addition of parameter/signal connection points and messages newly defined on the process tag type
 - Correction of modified categories of process tag type
 - Display of inconsistencies between process tag and type which cannot be matched automatically

Selection and Ordering Data

Order No.

SIMATIC PCS 7 Import/Export Assistant V7.0

6 languages (German, English, French, Italian, Spanish, Chinese), executes with Windows XP Professional, floating license for 1 user

Type of delivery:
License key disk, emergency key disk, certificate of license, terms and conditions

6ES7 658-1DX07-2YB5

Overview

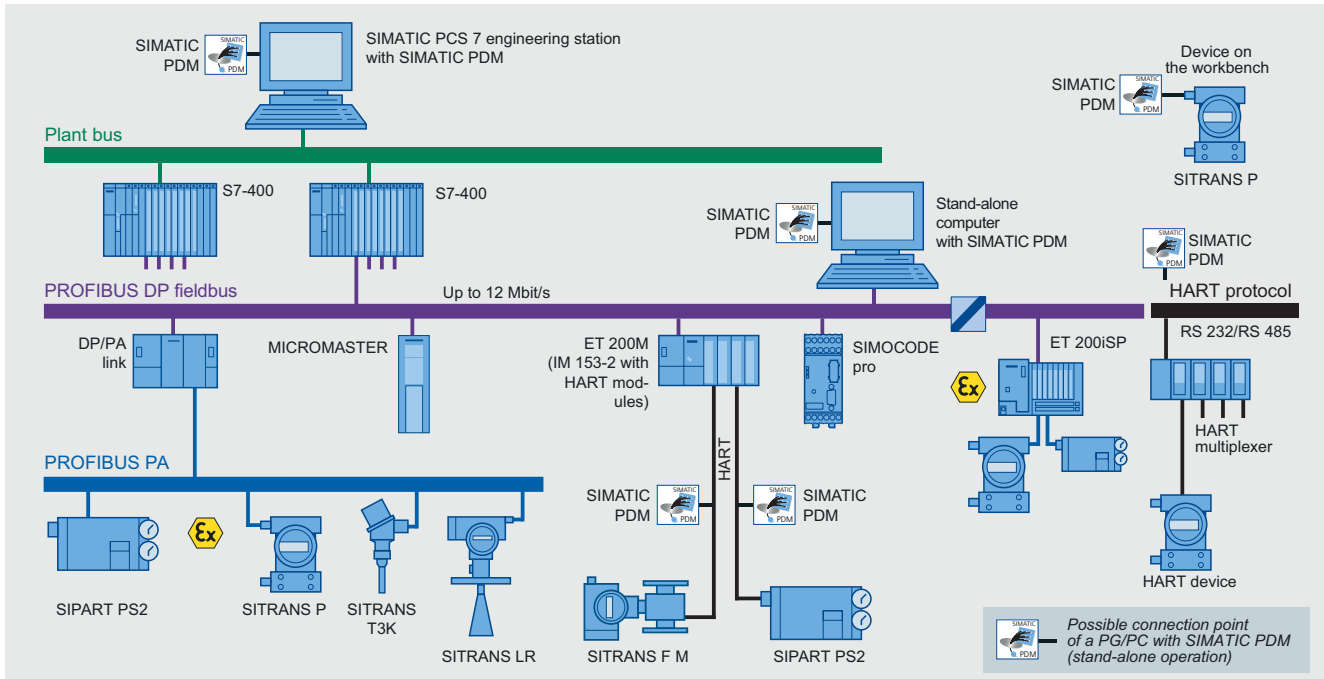

Configuration options with SIMATIC PDM

SIMATIC PDM (Process Device Manager) is a universal, vendor-independent tool for the configuration, parameterization, commissioning, diagnostics and servicing of intelligent field devices (sensors and actuators) and field components (remote I/Os, multiplexers, control-room devices, compact controllers), which in the following sections will be referred to simply as devices.

Using *one* software, SIMATIC PDM enables the processing of more than 1200 devices from Siemens and over 100 vendors worldwide on *one* homogeneous user interface. Parameters and functions for all supported devices are displayed in a consistent and uniform fashion independent of their communications interface.

From the viewpoint of device integration, SIMATIC PDM is the most powerful open device manager available in the world. Devices which previously were not supported can be easily integrated in SIMATIC PDM at any time by importing their device descriptions (EDD). This provides security for your investment and saves you investment costs, training expenses and consequential costs.

SIMATIC PDM is integrated in the asset management of SIMATIC PCS 7. The Process Device Manager provides wider information for all devices described by the Electronic Device Description (EDD), e.g. detailed diagnostics information (vendor information, information on fault diagnostics and troubleshooting, further documentation), modification logbook (audit trail), parameter information. It is possible to change directly to SIMATIC PDM from the diagnostics faceplates in the maintenance station.

Engineering system

ES software

SIMATIC PDM Process Device Manager

Design

Customer-oriented product structure

The SIMATIC PDM Process Device Manager can be used in a versatile manner in the context of Totally Integrated Automation (TIA). Use in the engineering system of SIMATIC PCS 7 is one possible application.

The customer-oriented products structure of SIMATIC PDM supports you in adaptation of the scope of functions and performance to your individual requirements. You can select the minimum configuration SIMATIC PDM Single Point, one of the application-specific, predefined product configurations SIMATIC PDM Service, SIMATIC PDM PCS 7 or SIMATIC PDM S7, or produce your desired configuration from the individual components offered (see table).

The selection depends on the application range and environment of use:

- System-integrated in a SIMATIC PCS 7/S7 configuration environment:
 - SIMATIC PDM PCS 7 (for integration in an engineering system for SIMATIC PCS 7)
 - SIMATIC PDM S7 (for integration in a SIMATIC S7 configuration environment)
- SIMATIC PDM stand-alone as service tool for operation on a mobile computer on the PROFIBUS or with direct connection to the device:
 - SIMATIC PDM Single Point (for processing of a single field device via a point-to-point coupling)
 - SIMATIC PDM Service (for enhanced servicing, including modification logbook and lifelist detailed diagnostics)

	SIMATIC PDM stand-alone			SIMATIC PDM system-integrated	
	Minimum configuration	Components for individual configuration	Predefined product configurations		
Product name	SIMATIC PDM Single Point	SIMATIC PDM Basic	SIMATIC PDM Service	SIMATIC PDM S7	SIMATIC PDM PCS 7
TAGs included in scope of delivery	1	4	128	128	128
TAG expansions	<i>Cannot be expanded</i>	TAG options - 128 TAGs - 512 TAGs - 1024 TAGs - 2048 TAGs and/or PowerPacks	PowerPacks - From 128 to 512 TAGs - From 512 to 1024 TAGs - From 1024 to 2048 TAGs - From 2048 to unlimited TAGs		
Option "Integration in STEP 7/PCS 7"		opt	opt	●	●
Option "Routing through S7-400"		opt	opt	opt	●
Option "Communication via standard HART multiplexer"		opt	opt	opt	opt

●: Components included in delivery of individual PDM configurations
 opt: Can be ordered as options

Note: For definition of TAG, see page 4/15.

Minimum configuration SIMATIC PDM Single Point

This low-cost minimum configuration with handheld functionality is tailored to processing exactly *one* field device via a point-to-point coupling. All device functions are supported as defined in the device description. These functions include:

- Unlimited selection of devices / management of device catalog
- Communication via PROFIBUS DP/PA or HART modem
- Parameterization and diagnostics in accordance with the device description
- Exporting and importing of parameter data
- Device identification
- Lifelist

The following system functions of SIMATIC PDM Basic are not available with SIMATIC PDM Single Point:

- EDD-based diagnostics in the lifelist
- Project editing
- Storage function (only exporting and importing of parameter data)
- Recording functions
- Routing
- Communication with HART field devices via remote I/Os

The functions of SIMATIC PDM Single Point cannot be extended (e.g. to SIMATIC PDM Basic or with the routing option through S7-400), nor can it be expanded with TAG options or PowerPacks.

Predefined product configurations

SIMATIC PDM Service

This is a predefined product configuration especially for mobile use in servicing for projects with up to 128 TAGs. It offers service engineers all functions of SIMATIC PDM Basic, including modification logbook, calibration report and detailed diagnostics in the lifelist. SIMATIC PDM Service can be expanded by the functional options "Integration in STEP 7/PCS 7", "Routing through S7-400" and "Communication via standard HART multiplexer" as well as by SIMATIC PDM PowerPacks (see under TAG options/PowerPacks). The following program components are part of SIMATIC PDM Service:

- SIMATIC PDM Basic
- Option: 128 TAGs

SIMATIC PDM PCS 7

SIMATIC PDM PCS 7 is a predefined product configuration for integration into the engineering system (engineering tool set) and the maintenance station of SIMATIC PCS 7. The product version designed for projects with up to 128 TAGs allows the use of all functions of SIMATIC PDM Basic (including modification logbook, calibration report and detailed diagnostics in the lifelist). In addition, it contains the functionality for integration of the SIMATIC PDM into HW-Config as well as the routing from the central engineering system to the field devices. SIMATIC PDM PCS 7 can be expanded by the option "Communication via standard HART multiplexer" and by SIMATIC PDM PowerPacks (see under TAG options/PowerPacks). The following program components are part of SIMATIC PDM PCS 7:

- SIMATIC PDM Basic
- Option: 128 TAGs
- Option: Integration in STEP 7/SIMATIC PCS 7
- Option: Routing through S7-400

SIMATIC PDM S7

SIMATIC PDM S7 is a predefined product configuration tailored to the use of SIMATIC PDM in a SIMATIC S7 configuration environment. It offers all functions of SIMATIC PDM Basic (including modification logbook, calibration report and detailed diagnostics in the lifelist) as well as the functionality for integration of PDM into HW-Config. SIMATIC PDM S7 can be expanded by the functional options "Routing through S7-400" and "Communication via standard HART multiplexer" and by SIMATIC PDM PowerPacks (see under TAG options/PowerPacks). The following program components are part of SIMATIC PDM S7:

- SIMATIC PDM Basic
- Option: 128 TAGs
- Option: Integration in STEP 7/SIMATIC PCS 7

Components for individual configuration

SIMATIC PDM Basic

SIMATIC PDM Basic is the basic component for production of individual SIMATIC PDM configurations from single components. It contains all functions required for operation and parameterization of the devices, as well as enabling for the following communication modes:

- PROFIBUS DP/PA,
- HART communication (modem, RS 232 and PROFIBUS),
- Modbus,
- SIREC bus and
- SIPART DR.

Without TAG expansion, SIMATIC PDM Basic can manage projects with up to 4 TAGs, and can be used - with observation of the system requirements - for stand-alone operation on any computer (PC/notebook) with local connection to bus segments or with direct connection to the device.

SIMATIC PDM Basic can be expanded by functional options and TAG options/PowerPacks. Use of the following functions requires at least 128 TAGs:

- Modification logbook
- Calibration report
- Detailed diagnostics in the lifelist

SIMATIC PDM Basic is also available in the form of a rental license for 50 operating hours for low-cost processing of short-term projects.

SIMATIC PDM option: Integration in STEP 7/PCS 7

This option is required for use of SIMATIC PDM within a SIMATIC S7 or SIMATIC PCS 7 project with a local connection to the PROFIBUS. SIMATIC PDM can then be started directly from the hardware project (HW-Config).

SIMATIC PDM option: Routing through S7-400

This option is required additive to the option "Integration in STEP7/PCS 7" if SIMATIC PDM is to be used in a central engineering system for SIMATIC PCS 7/S7 with Ethernet bus connection to the automation systems for plant-wide configuration, parameterization, commissioning and diagnostics of field devices.

SIMATIC PDM option: Communication via standard HART multiplexer

This option permits SIMATIC PDM to use the HART OPC server for communication with HART field devices via HART multiplexers.

TAG options/PowerPacks

A TAG corresponds to a SIMATIC PDM object, which represents individual field devices or components within a project, e.g. measuring instruments, positioners, switching devices or remote I/Os. TAGs are also relevant for diagnostics with the lifelist of SIMATIC PDM. In this case, TAGs are considered to be all recognized devices with diagnostics capability, whose detailed diagnostics is effected through the device description (EDD).

In contrast to PowerPacks, TAG options are only suitable for product configurations on the basis of individual components. Using the SIMATIC PDM TAG options, the basic software SIMATIC PDM Basic can be expanded from 4 TAGs to 128, 512, 1024 or 2048 TAGs, and with the help of an additive PowerPack also to unlimited TAGs.

The number of available TAGs can be subsequently increased for all SIMATIC PDM product configurations by means of the SIMATIC PDM PowerPacks. PowerPacks are available for expansion to 512, 1024, 2048 and unlimited TAGs.

Demonstration software

A demonstration version of SIMATIC PDM is also available. Online communication and storage functions are not available with this version.

Engineering system ES software

SIMATIC PDM Process Device Manager

Function

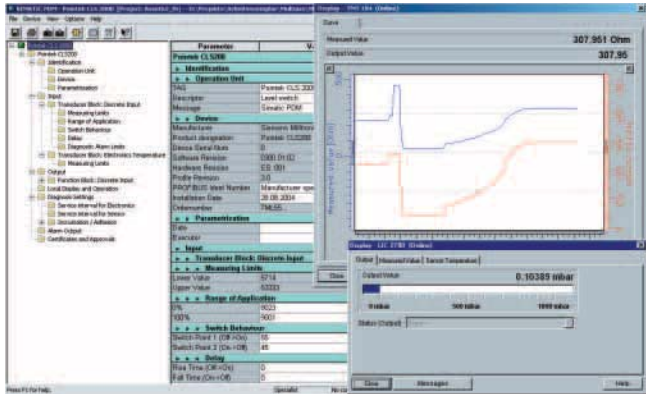

Parameter view of SIMATIC PDM with trend curve and online display

Core functions

- Adjustment and modification of device parameters
- Comparing (e.g. project and device data)
- Plausibility testing of data input
- Device identification and testing
- Device status indication with operating modes, alarms and states
- Simulation
- Diagnostics (standard, detailed)
- Management (e.g. networks and PCs)
- Export/import (parameter data, reports)
- Commissioning functions, e.g. measuring circuit tests of device data
- Device replacement (lifecycle management)
- Global and device-specific modification logbook for user operations (audit trail)
- Device-specific calibration reports
- Graphic presentations of echo envelope curves, trend displays, valve diagnosis results etc.
- Presentation of incorporated manuals
- Document manager for integration of up to 10 multimedia files

Support of system management

SIMATIC PDM supports the operative system management in particular through:

- Uniform presentation and operation of devices
- Indicators for preventive maintenance and servicing
- Detection of changes in the project and device
- Increasing the operational reliability
- Reducing the investment, operating and maintenance costs
- Graded user privileges including password protection

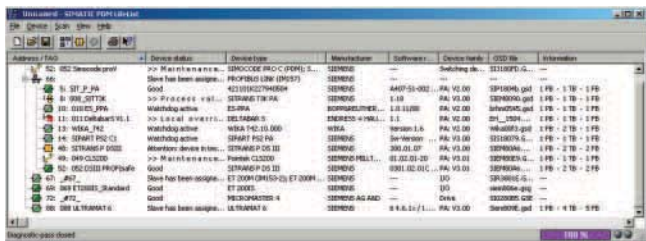

PDM lifelist with status and diagnostics display

Graphical user interface

The GUI of SIMATIC PDM satisfies the requirements of the directives VDI/VDE GMA 2187 and IEC 65/349/CD. Even complex devices with several hundred parameters can thus be represented clearly and processed quickly. Using SIMATIC PDM it is very easy to navigate in highly complex stations such as remote I/Os and even connected field devices.

Several views are available to users to help them with their tasks:

- Hardware project view
- Process device network view (preferably for stand-alone application)
- Process device plant view as TAG-related view, also with display of diagnostics information
- Parameter view for parameterizing the field devices
- Lifelist view for commissioning and service

Communication

SIMATIC PDM supports several communication protocols and components for communicating with devices that have the following interfaces:

- PROFIBUS DP/PA interface
- HART interface
- Modbus interface
- Special interface from Siemens

Further communication protocols on request.

Routing

From the central engineering system of the SIMATIC PCS 7 process control system, you can navigate with SIMATIC PDM through the various bus systems and remote I/Os down to the connected devices. By means of this routing functionality, every device in the plant which can be parameterized per EDD can be processed. The following processing functions are available:

- Read diagnostics information from the device
- Modify device settings
- Adjust and calibrate devices
- Monitor process values
- Create simulation values
- Reparameterize devices.

Integration**Device Integration**

SIMATIC PDM supports all devices described by EDD (Electronic Device Description). EDD is standardized to EN 50391 and IEC 61804. Internationally it is the most widely used standardized technology for device integration. At the same time it is the directive of the established organizations for PROFIBUS (PNO: PROFIBUS International) and HART (HCF: HART Communication Foundation).

The devices are directly integrated in SIMATIC PDM through their EDD or the current HCF catalog. In the EDD the device is described in terms of its functions and construction using the Electronic Device Description Language (EDDL) specified by PNO. Using this description, SIMATIC PDM automatically creates its user interface with the specific device data.

The current device catalog of SIMATIC PDM covers more than 1200 devices from over 100 manufacturers world-wide. In addition, devices from all manufacturers can be integrated in SIMATIC PDM by simply importing their EDDs. It is thus possible to keep the device range up to date at all times and to add to the number of manufacturers and devices supported by SIMATIC PDM. To permit improved transparency, SIMATIC PDM also allows the creation of project-specific device catalogs. If devices are to be used which cannot be found in the SIMATIC PDM device catalog, we will be glad to help you integrate them.

Contact addresses

Siemens AG, Automation and Drives,
Technical Support

Europe

Phone: +49 180 50 50 222

Fax: +49 180 50 50 223

E-mail: FPlease fill in a Support Request on the Internet (see below for address)

Asia/Pacific

Phone: +86 1064 719 990

Fax: +86 1064 747 474

E-mail: adsupport.asia@siemens.com

America

Phone: +1 423 262 2522

Fax: +1 423 262 2200

E-mail: techsupport.sea@siemens.com

Support Request

Additional information is available in the Internet under:



<http://www.siemens.com/automation/support-request>

Technical specifications**Requirements for stand-alone operation****Hardware**

- PG/PC/notebook with processor corresponding to operating system requirements

- Main memory 256 MB or more

- Vacant hard disk 210 MB or more

Operating systems (alternative)

- Microsoft Windows 2000 Professional SP1 or higher

- Microsoft Windows XP Professional SP1/SP2

Further software components

- SIMATIC PDM integrated in STEP 7

STEP 7 V5.1 or higher with ServicePack 6 or higher, order separately

Selection and ordering data for SIMATIC PCS 7 applications**Selection and Ordering Data**

Order No.

SIMATIC PDM PCS 7 V6.0

Complete package for integration into the engineering toolset of the SIMATIC PCS 7 engineering system

6 languages (German, English, French, Italian, Spanish, Chinese), executes with Windows XP Professional

Floating license for 1 user, with

- SIMATIC PDM Basic

- Option "Integration in STEP 7/PCS 7"

- Option "Routing through S7-400"

- Option "128 TAGs"

Type of delivery:

License key disk, emergency key disk, certificate of license, terms and conditions; 2 CDs with SIMATIC PDM V6.0 and device library as well as supplementary DVD with Microsoft ServicePacks and tools

6ES7 658-3LX06-0YA5**PowerPacks****SIMATIC PDM PowerPack**

for expanding the TAGs of SIMATIC PDM PCS 7 V6.0

6 languages (German, English, French, Italian, Spanish, Chinese), executes with Windows XP Professional

Floating license for 1 user

Type of delivery:

License key disk, certificate of license, terms and conditions

- From 128 TAGs to 512 TAGs

- From 512 TAGs to 1024 TAGs

- From 1024 TAGs to 2048 TAGs

- From 2048 TAGs to unlimited TAGs

6ES7 658-3XB06-2YD5**6ES7 658-3XC06-2YD5****6ES7 658-3XD06-2YD5****6ES7 658-3XH06-2YD5**

Engineering system

ES software

SIMATIC PDM Process Device Manager

Selection and Ordering Data Order No.

Demonstration software

SIMATIC PDM Demo V6.0

without online communication and storage functionality

6 languages (German, English, French, Italian, Spanish, Chinese), executes with Windows XP Professional

Type of delivery:

2 CDs with SIMATIC PDM V6.0 and device library as well as supplementary DVD with Microsoft ServicePacks and tools

6ES7 658-3GX06-0YC8

SIMATIC PDM Upgrade/Update Service

SIMATIC PDM Upgrade from V5.x to V6.0

for all product versions and combinations

6 languages (German, English, French, Italian, Spanish, Chinese), executes with Windows XP Professional, floating license for 1 user

Type of delivery:

License key disk, emergency key disk, certificate of license, terms and conditions; 2 CDs with SIMATIC PDM V6.0 and device library as well as supplementary DVD with Microsoft ServicePacks and tools

6ES7 651-5CX06-0YE5

SIMATIC PDM Software Update Service

Subscription for 1 year with automatic extension

Requirement: current software version

6ES7 658-3XX00-0YL8

SIMATIC PDM belongs to the SIMATIC products which can be used both in the context of SIMATIC PCS 7 and in the extended context of Totally Integrated Automation (TIA). Depending on the field of application, SIMATIC PDM is used in various product versions with different functionalities, ordering data and type of delivery. To provide a better overview and to avoid faulty ordering, the special selection and ordering data for SIMATIC PCS 7 are listed separately.

Selection and ordering data for TIA applications

Selection and Ordering Data Order No.

Minimum configuration SIMATIC PDM Single Point

SIMATIC PDM Single Point V6.0

for operation and parameterization of one field device; communication via PROFIBUS DP/PA or HART modem, including 1 TAG,

cannot be expanded with respect to functions or with TAG option/PowerPack

6 languages (German, English, French, Spanish, Italian, Chinese), executes with Windows 2000 Professional or Windows XP Professional

Floating license for 1 user

Type of delivery:

License key disk, certificate of license, terms and conditions; 2 CDs with SIMATIC PDM V6.0 and device library

6ES7 658-3HX06-0YA5

Selection and Ordering Data Order No.

Predefined SIMATIC PDM V6.0 product configurations for special applications

SIMATIC PDM Service V6.0

Complete package for stand-alone users for servicing, with

- SIMATIC PDM Basic V6.0
- Option "128 TAGs"

6 languages (German, English, French, Italian, Spanish, Chinese), executes with Windows 2000 Professional or Windows XP Professional, floating license for 1 user

Type of delivery:

License key disk, emergency key disk, certificate of license, terms and conditions; 2 CDs with SIMATIC PDM V6.0 and device library as well as supplementary DVD with Microsoft ServicePacks and tools

6ES7 658-3JX06-0YA5

SIMATIC PDM S7 V6.0

Complete package for use in a SIMATIC S7 configuration environment, with

- SIMATIC PDM Basic V6.0
- Option "Integration in STEP 7/PCS 7"
- Option "128 TAGs"

6 languages (German, English, French, Italian, Spanish, Chinese), executes with Windows 2000 Professional or Windows XP Professional, floating license for 1 user

Type of delivery:

License key disk, emergency key disk, certificate of license, terms and conditions; 2 CDs with SIMATIC PDM V6.0 and device library as well as supplementary DVD with Microsoft ServicePacks and tools

6ES7 658-3KX06-0YA5

Components for individual configuration

SIMATIC PDM Basic V6.0

for operation and parameterization of field devices and components, communication via PROFIBUS DP/PA, HART (modem, RS 232, PROFIBUS) and Modbus, including 4 TAGs

6 languages (German, English, French, Spanish, Italian, Chinese), executes with Windows 2000 Professional or Windows XP Professional

Type of delivery:

License key disk, emergency key disk, certificate of license, terms and conditions; 2 CDs with SIMATIC PDM V6.0 and device library

- Floating license for 1 user
- Rental license for 50 hours

6ES7 658-3AX06-0YA5

6ES7 658-3AX06-0YA6

Selection and Ordering Data	Order No.	Selection and Ordering Data	Order No.
<p>Integration in STEP 7 / SIMATIC PCS 7 Only required if integration of SIMATIC PDM into HW-Config is to be used</p> <p>6 languages (German, English, French, Spanish, Italian, Chinese), executes with Windows 2000 Professional or Windows XP Professional</p> <p>Type of delivery: License key disk, emergency key disk, certificate of license, terms and conditions</p> <ul style="list-style-type: none"> Floating license for 1 user 	6ES7 658-3BX06-2YB5	<p>SIMATIC PDM PowerPack for subsequent TAG expansion of all SIMATIC PDM V6.0 product configurations</p> <p>6 languages (German, English, French, Spanish, Italian, Chinese), executes with Windows 2000 Professional or Windows XP Professional</p> <p>Floating license for 1 user</p> <p>Type of delivery: License key disk, certificate of license, terms and conditions</p> <ul style="list-style-type: none"> From 128 TAGs to 512 TAGs From 512 TAGs to 1024 TAGs From 1024 TAGs to 2048 TAGs From 2048 TAGs to unlimited TAGs 	<p>6ES7 658-3XB06-2YD5</p> <p>6ES7 658-3XC06-2YD5</p> <p>6ES7 658-3XD06-2YD5</p> <p>6ES7 658-3XH06-2YD5</p>
<p>Routing through S7-400 6 languages (German, English, French, Spanish, Italian, Chinese), executes with Windows 2000 Professional or Windows XP Professional</p> <p>Type of delivery: License key disk, emergency key disk, certificate of license, terms and conditions</p> <ul style="list-style-type: none"> Floating license for 1 user 	6ES7 658-3CX06-2YB5	<p>Demonstration software</p> <p>SIMATIC PDM Demo V6.0 without online communication and storage functionality</p> <p>6 languages (German, English, French, Spanish, Italian, Chinese), executes with Windows 2000 Professional or Windows XP Professional</p> <p>Type of delivery: 2 CDs with SIMATIC PDM V6.0 and device library</p>	6ES7 658-3GX06-0YC8
<p>Communication via standard HART multiplexer 6 languages (German, English, French, Spanish, Italian, Chinese), executes with Windows 2000 Professional or Windows XP Professional</p> <p>Type of delivery: License key disk, emergency key disk, certificate of license, terms and conditions</p> <ul style="list-style-type: none"> Floating license for 1 user 	6ES7 658-3EX06-2YB5	<p>SIMATIC PDM Upgrade/Update Service</p> <p>SIMATIC PDM Upgrade from V5.x to V6.0 for all product versions and combinations</p> <p>6 languages (German, English, French, Italian, Spanish, Chinese), executes with Windows 2000 Professional or Windows XP Professional, floating license for 1 user</p> <p>Type of delivery: License key disk, emergency key disk, certificate of license, terms and conditions; 2 CDs with SIMATIC PDM V6.0 and device library</p>	6ES7 651-5CX06-0YE5
<p>TAG options / PowerPacks</p> <p>SIMATIC PDM TAG option for TAG expansion, additive to SIMATIC PDM Basic V6.0</p> <p>6 languages (German, English, French, Spanish, Italian, Chinese), executes with Windows 2000 Professional or Windows XP Professional</p> <p>Floating license for 1 user</p> <p>Type of delivery: License key disk, certificate of license, terms and conditions</p> <ul style="list-style-type: none"> Up to 128 TAGs Up to 512 TAGs Up to 1024 TAGs Up to 2048 TAGs 	<p>6ES7 658-3XA06-2YB5</p> <p>6ES7 658-3XB06-2YB5</p> <p>6ES7 658-3XC06-2YB5</p> <p>6ES7 658-3XD06-2YB5</p>	<p>SIMATIC PDM Software Update Service Subscription for 1 year with automatic extension</p> <p>Requirement: current software version</p>	6ES7 658-3XX00-0YL8

Engineering system

Engineering Process Safety

Introduction

Overview

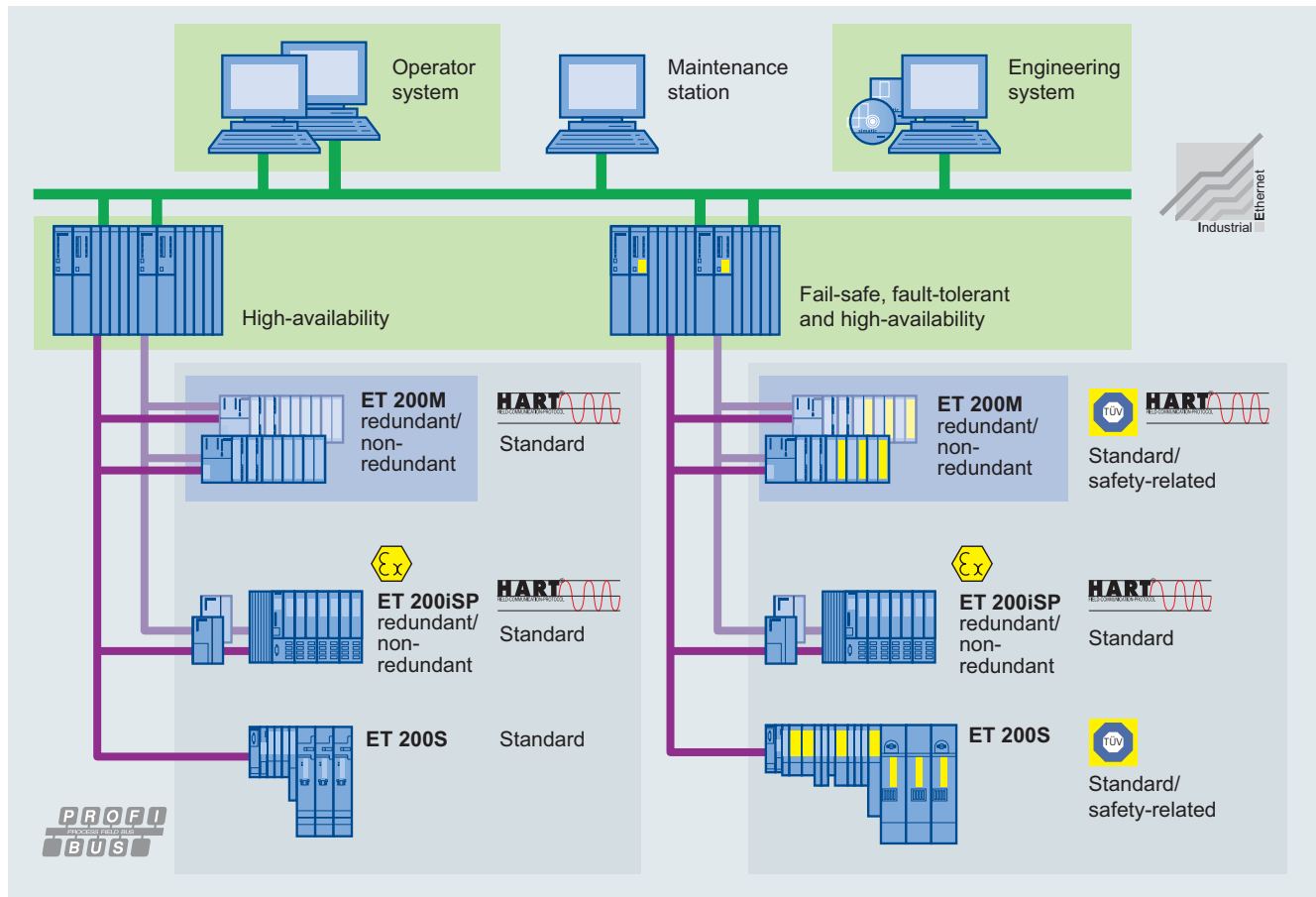

Common engineering system for basic process control system and safety instrumented system

The process industry frequently features complex technological sequences with high safety demands, and faults and failures in the process automation could have fatal consequences for personnel, machines, plants and the environment. Therefore process safety is of particular significance. The safety technology used must reliably detect errors in the process and also its own internal errors, and automatically set the plant/application to a safe state if an error is detected.

Safety Integrated for Process Automation is the comprehensive range of products and services from Siemens for safe, fault-tolerant applications in the process industry. This is characterized by:

- AS 412F/FH, AS 414F/FH and AS 417F/FH safety-related automation systems
- Failsafe PROFIBUS communication using the PROFIsafe profile
- Failsafe transmitters (SITRANS P DS III) on the PROFIBUS PA with PROFIsafe
- ET 200M and ET 200S distributed I/O systems with safety-related I/O modules
- User-friendly process visualization via the operator system, including safety-relevant fault messages
- Engineering system with S7 F Systems software package, CFC and SIMATIC Safety Matrix
- Safety lifecycle management with support of highly qualified solution partners: services for all phases of the lifecycle of a safety instrumented system (analysis, implementation and operation)

Benefits

Safety Integrated for Process Automation permits complete integration of safety engineering into the SIMATIC PCS 7 process control system. The Basic Process Control System (BPCS) and Safety Instrumented System (SIS) melt together into a uniform and innovative complete system. The advantages of this fusion are quite clear:

- One common controller platform
- One common engineering system
- No separate safety bus - standard and safety-related communication take place on the same fieldbus (PROFIBUS with PROFIsafe)
- Mixed operation of standard and safety-related I/O modules in ET 200M and ET 200S remote I/O stations
- Uniform data management - no complex data exchange between BPCS and safety system
- Integration of safety-related applications into process visualization on the operator station
- Automatic integration of safety-related fault messages with time tagging into the process control system
- Integration of safety-related hardware into the SIMATIC PCS 7 asset management for diagnostics and preventive maintenance

The SIMATIC PCS 7 engineering system is a universal tool equally suitable for BPCS and safety applications.

Using the S7 F Systems engineering tool, you can parameterize the AS 414F/FH and AS 417F/FH automation systems as well as the safety-related F-modules of the ET 200M and ET 200S I/O systems.

Using Continuous Function Chart (CFC) and predefined function blocks from the F-block library of S7 F Systems, you can configure safety-related applications simply, efficiently and without weary acquaintance.

However, this is even simpler, more convenient and faster using the SIMATIC Safety Matrix based on CFC. The configuration tool functioning according to the principle of a Cause&Effect matrix automatically creates complex safety programs once you have assigned the events (causes) occurring during a process to exactly defined reactions (effects).

Engineering system

Engineering Process Safety

Engineering F/FH systems

Overview

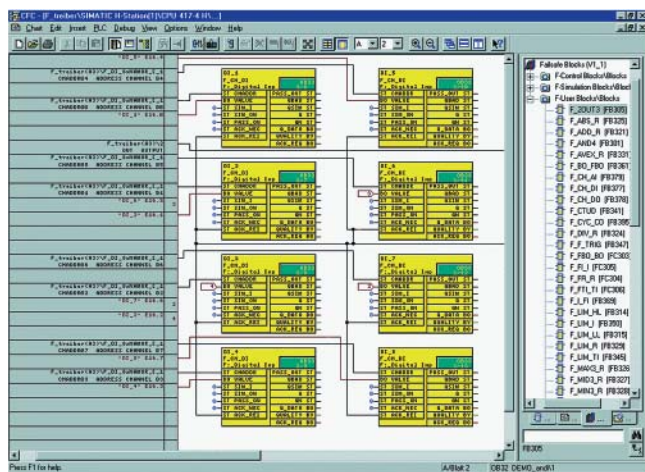

The engineering tool S7 F Systems integrated in the SIMATIC Manager can be used to configure an F system (F/FH). With this tool you can:

- Parameterize CPU and F-signal modules
- Create safety-related applications in the CFC.

Predefined, TÜV-approved blocks are available for this purpose. The safety-related blocks save the user having to perform redundant programming for detecting and reacting to errors.

Configuration

- S7 F Systems supports configuration by means of functions for
- Comparison of safety-related F-programs
 - Recognition of changes in the F-program using the checksum
 - Separation of safety-related and standard functions.

Access to the F-functions can be password-protected.

The F-block library integrated in S7 F Systems contains predefined function blocks for generation of safety-related applications with the CFC or the SIMATIC Safety Matrix based on it. The certified F-blocks are extremely robust and intercept programming errors such as division by zero or out-of-range values. They avoid the need for diverse programming tasks for detecting and reacting to errors.

Selection and Ordering Data

Order No.

S7 F Systems V6.0

Programming and configuration environment for creating and using safety-related STEP 7 programs for a target system based on S7-400H

2 languages (German, English), executes with Windows XP Professional SP2, Windows Server 2003 SP1/SP2 and Windows 2000 SP4, floating license for 1 user

Type of delivery: Certificate of license as well as software and electronic documentation on CD

6ES7 833-1CC01-0YA5

S7 F Systems Upgrade from V5.x to V6.0

2 languages (German, English), executes with Windows XP Professional SP2, Windows Server 2003 SP1/SP2 and Windows 2000 SP4, floating license for 1 user

Type of delivery: Certificate of license as well as software and electronic documentation on CD

6ES7 833-1CC01-0YE5

Note:

With a S7 F Systems Upgrade from V5.x to V6.0, the type of S7 F Systems license changes from single license to floating license.

Options

S7 F ConfigurationPack

When using the safety-related SM 326F/336F I/O modules (AI, DI, DO) as standard I/Os (without F-functionality), an S7 F ConfigurationPack is required for engineering. This is included in S7 F Systems V6.0, and is also available on the Internet for downloading.

Additional information is available in the Internet under:



<http://support.automation.siemens.com/WW/view/de/15208817>

Overview

The SIMATIC Safety Matrix which can be used in addition to the CFC is an innovative safety lifecycle tool from Siemens that can be used not only for user-friendly configuration of safety applications, but also for their operation and service. The tool, which is based on the proven principle of a cause & effect matrix, is ideally suited to processes where defined statuses require specific safety reactions.

The SIMATIC Safety Matrix not only means that programming of the safety logic is significantly simpler and more convenient, but also much faster than in the conventional manner. During the risk analysis of a plant, the configuration engineer can assign exactly defined reactions (effects) to events (causes) which may occur during a process.

Benefits

The advantages of the SIMATIC Safety Matrix in the implementation phase:

- Simple programming using Cause&Effect method
- No programming knowledge required
- Automatic generation of CFCs including driver blocks
- Automatic version tracking
- integrated change tracking
- 1-to-1 printout of Cause&Effect matrix

Design

In the context of SIMATIC PCS 7, the following individual products are offered for the SIMATIC Safety Matrix:

- *SIMATIC Safety Matrix Tool*
for configuration of safety functions on the SIMATIC PCS 7 engineering system
- *SIMATIC Safety Matrix Editor*
for creating and debugging the Safety Matrix logic in an external computer, independent of the engineering system (can be optionally used additive to the SIMATIC Safety Matrix Tool)
- *SIMATIC Safety Matrix Viewer for SIMATIC PCS 7*
for operation and monitoring of the SIMATIC Safety Matrix using the SIMATIC PCS 7 operator system (for ordering data, refer to page 5/15)

System requirements

	Hardware requirement	Software requirement
SIMATIC Safety Matrix Tool	SIMATIC PCS 7 AS 412H/F/FH, AS 414H/F/FH or AS 417H/F/FH (S7 F Systems RT license is integrated in the case of F/FH systems)	SIMATIC PCS 7 V6.0 SP2 or higher, S7 F Systems V5.2 HF 2 or higher with S7 F-Lib V1.2
SIMATIC Safety Matrix Editor		Windows 2000 Professional SP2 or higher or Windows XP Professional
SIMATIC Safety Matrix Viewer	SIMATIC PCS 7 AS 412H/F/FH, AS 414H/F/FH or AS 417H/F/FH (S7 F Systems RT license is integrated in the case of F/FH systems)	SIMATIC PCS 7-OS V6.0 SP2 or higher

The SIMATIC Safety Matrix Editor offers the advantage that the Safety Matrix can also be created, processed further and debugged outside the SIMATIC PCS 7 engineering system. The SIMATIC Safety Matrix Editor can be used on a computer with Windows 2000 Professional SP2 or higher or Windows XP Professional. However, generation of the safety-related CFC program as well as compilation and downloading to the automation system are only possible by means of the SIMATIC engineering system with the SIMATIC Safety Matrix Tool.

Engineering system Engineering Process Safety

SIMATIC Safety Matrix

Function

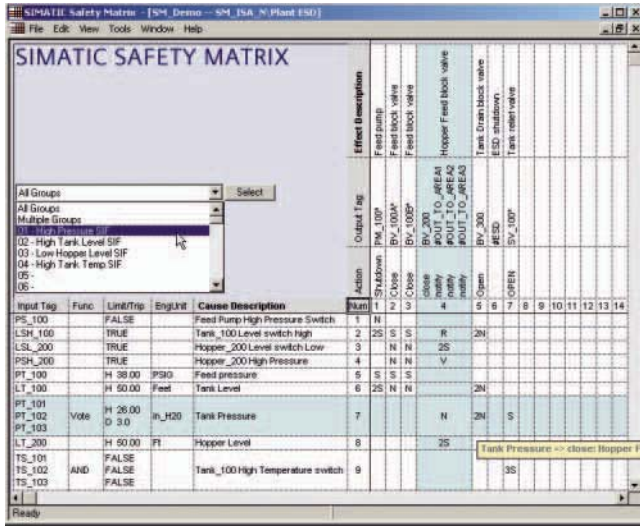

Safety Matrix: intersections define the linking of causes and effects

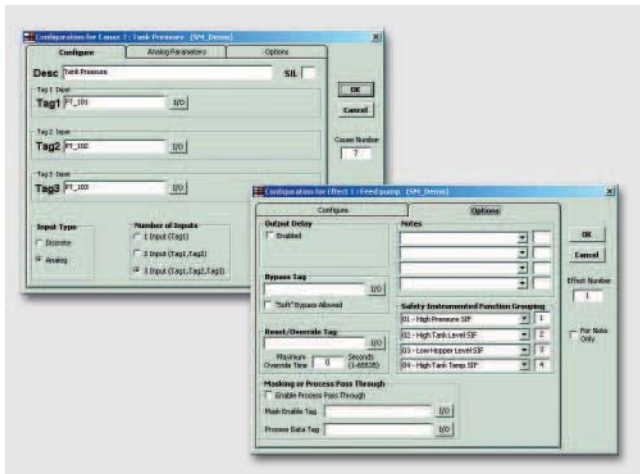

Configuration of analog or digital causes and their digital effects

The matrix table is comparable with a spreadsheet program, and the configuration engineer first enters the possible process events (inputs) in the horizontal lines, and then configures their type and number, logical links, possible delays and interlocks, and any tolerable faults. In the vertical columns, he subsequently defines the reactions (outputs) to a particular event.

Events and reactions are linked simply by clicking the cell at the intersection of the row and column. Using these data, the SIMATIC Safety Matrix automatically generates complex, safety-related CFC programs. No special programming knowledge is required of the configuration engineer, and he can completely concentrate on the safety requirements of the plant.

Selection and Ordering Data

Order No.

SIMATIC Safety Matrix Tool

Creation, configuration, compilation, loading and online monitoring of the Safety Matrix in a SIMATIC PCS 7 environment

Including SIMATIC Safety Matrix Viewer for SIMATIC PCS 7, for operation and monitoring of the Safety Matrix in a SIMATIC PCS 7 environment with several operator control levels

1 language (English), executes with Windows XP Professional, floating license for 1 user

Type of delivery: Certificate of license and authorization diskette for Safety Matrix Tool and Safety Matrix Viewer; software and electronic documentation on CD

6ES7 833-1SM00-0YA5

C)

SIMATIC Safety Matrix Editor

Creation and checking of the Safety Matrix logic on an external computer without a SIMATIC PCS 7/ STEP 7 environment

1 language (English), executes with Windows 2000 Professional or Windows XP Professional, floating license for 1 user

Type of delivery: Certificate of license and authorization diskette; software and electronic documentation on CD

6ES7 833-1SM40-0YA5

C)

C) Subject to export regulations: AL: N, ECCN: EAR99S

Overview

The SIMATIC PCS 7 standard engineering software can be ordered together with software components for engineering the integrated safety technology as low-cost all-in-one packages.

Their composition depends on the application of the SIMATIC PCS 7 Engineering Station:

- A combined engineering/operator station for small applications (productive operation as an operator station is possible)
- Exclusive engineering station without limitation of quantities (cannot be used for productive operation as an operator station)

The engineering software for basic process control and safety applications can now be ordered using one single Order No.

An engineering station can also be subsequently extended using S7 F Systems and SIMATIC Safety Matrix Tool using the SIMATIC PCS 7 Safety Matrix ES Extension Package.

Selection and Ordering Data Order No.

SIMATIC PCS 7 Safety ES Packages

SIMATIC PCS 7 Safety ES Package for AS/OS

Executes with Windows XP Professional, floating license for 1 user

Combination of S7 F Systems, 2 languages (German, English) and SIMATIC PCS 7 Engineering Software AS/OS, 6 languages (German, English, French, Italian, Spanish, Chinese)

- **250 POs**

incl. AS/OS Engineering and Runtime licenses for 250 POs

6ES7 651-6AA07-0YA5

- **Unlimited POs**

incl. AS/OS Engineering license for unlimited POs and AS Runtime license for 600 POs (2-hour OS test mode possible)

6ES7 651-6AF07-0YA5

SIMATIC PCS 7 Safety Matrix ES Package for AS/OS

Executes with Windows XP Professional, floating license for 1 user

Combination of S7 F Systems, 2 languages (German, English) SIMATIC Safety Matrix Tool, 1 language (English) SIMATIC PCS 7 Engineering Software AS/OS, 6 languages (German, English, French, Italian, Spanish, Chinese)

- **250 POs**

incl. AS/OS Engineering and Runtime licenses for 250 POs

6ES7 651-6BA07-0YA5

- **Unlimited POs**

incl. AS/OS Engineering license for unlimited POs and AS Runtime license for 600 POs (2-hour OS test mode possible)

6ES7 651-6BF07-0YA5

SIMATIC PCS 7 Safety Matrix ES Extension Package

Executes with Windows XP Professional, floating license for 1 user

Combination of: S7 F Systems, 2 languages (German, English) SIMATIC Safety Matrix Tool, 1 language (English)

6ES7 651-6BX07-0YA5

Engineering system Simulation

Simulation with S7-PLCSIM

Overview

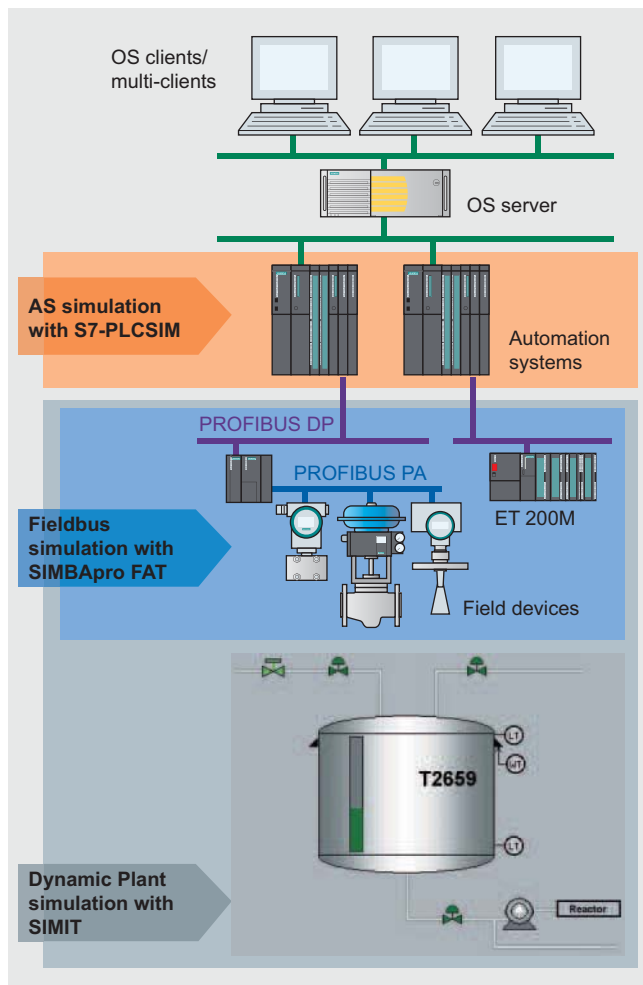

Overview of simulation software for SIMATIC PCS 7

Using the S7-PLCSIM simulation software, user programs created with CFC/SFC can be tested on a PG/PC, regardless of whether the target hardware is available. The detection and elimination of errors is thus brought forward into an early phase of development. This results in faster commissioning, lower costs and better program quality.

Function

S7-PLCSIM simulates a SIMATIC S7 CPU with the associated process images. The program to be tested is loaded into the simulated S7 CPU in a manner identical to the procedure with real hardware, and is executed there. S7-PLCSIM is completely integrated in STEP 7. Process data can be exchanged between S7-PLCSIM and other Windows applications via an interface.

Selection and Ordering Data

S7-PLCSIM V5.4

Functional testing of programs which were created with CFC/SFC, on PC/PG

5 languages (German, English, French, Italian, Spanish), executes with Windows 2000 Professional or Windows XP Professional, floating license for 1 user

Type of delivery: Authorization diskette, certificate of license, terms and conditions; software and electronic documentation on CD

- S7-PLCSIM V5.4
- S7-PLCSIM upgrade from V3.x, V4.x, V5.0, V5.2 or V5.3 to V5.4

Order No.
6ES7 841-0CC05-0YA5

6ES7 841-0CC05-0YE5

S7-PLCSIM Software Update Service

Subscription for 1 year with automatic extension; requirement: current software version

6ES7 841-0CA01-0YX2

For further programs concerning testing and simulation, see the catalog "Add Ons for the SIMATIC PCS 7 Process Control System".

Operator system



5/2	Introduction
5/4	OS hardware
5/4	Introduction
5/6	OS basic hardware
5/8	Signal output
5/9	OS software
5/9	Introduction
5/12	OS standard software for single station/server/client
5/14	SFC Visualization
5/15	SIMATIC PCS 7 Safety Matrix OS Packages
5/16	Redundant operator systems
5/16	OS redundancy
5/19	OS archiving
5/19	Introduction
5/20	OS short-term archiving
5/21	OS long-term archiving with StoragePlus
5/23	OS long-term archiving with Central Archive Server
5/25	Operation and monitoring via Web
5/25	SIMATIC PCS 7 Web server
5/27	Data exchange with host systems
5/27	OpenPCS 7



Operator system

Introduction

Overview

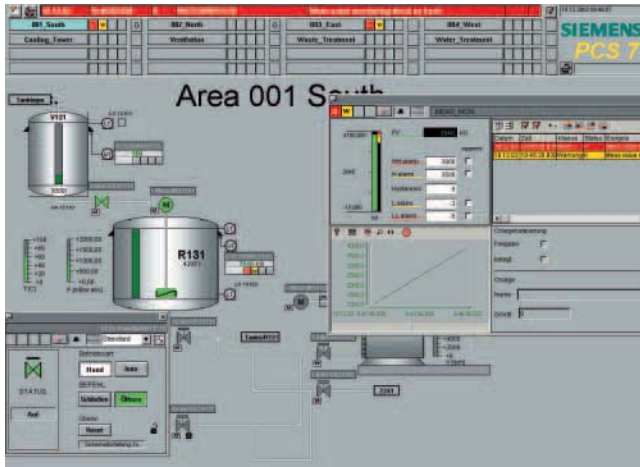

User interface of the OS process control system with freely positionable windows

The operator system of the SIMATIC PCS 7 process control system permits user-friendly and secure execution of the process by the operating personnel. The operator can observe the process sequence by means of various views and intervene to control the system when necessary.

The operator system architecture is extremely variable and can be flexibly adapted to different plant architectures and customer requirements.

The basis is formed by perfectly coordinated operator stations for single-user systems (OS single stations) and for multi-user systems with client/server architecture.

The system software of the operator stations is available in different levels based on the number of process objects (PO) used:

- 250, 1000, 2000, 3000 or 5000 POs per OS single station
- 250, 1000, 2000, 3000, 5000 or 8500 POs per OS server (with client/server architecture)

The number of POs for an operator station can be increased up to 5000 (OS single station) or 8500 (OS server) at any time by means of PowerPacks to allow for higher requirements or system expansions.

Benefits

- Flexible, modular architecture with scalable hardware and software components for single-user and multi-user systems
- High-performance operated stations based on standard PC technology with Microsoft Windows XP Professional / Server 2003, can be used in office or industrial environments
- Client/server multi-user systems with up to 12 OS servers/pairs of servers, each for 8500 process objects (PO) and up to 32 OS clients per server/pair of servers
- High-performance archive system based on Microsoft SQL server with cyclic archives and integral data backup, optionally with long-term archiving via StoragePlus/central archive server (CAS)
- OS health check for monitoring important server applications
- Integration of modifications without interrupting runtime operations, and online testing through selective loading of redundant servers
- Optimized AS/OS communication: data transmission only following change in data, independent of AS reply cycle; suppression of nuisance alarms
- User-friendly process control and high operational reliability, also in conjunction with multi-screen technology
- Extended status displays through combination of status and analog values with alarm information
- Alarm suppression during startup or on malfunction of a sensor/actuator
- Dynamic or manual hiding of visual and acoustic alarms that are unimportant depending on the plant status, e.g. during plant startup (however, all messages are recorded and archived); with manual hiding, the duration until display takes place again can be set.
- Alarm priorities as additional attribute for filtering important messages
- Central user management, access control, electronic signature
- Sign-of-life monitoring for subordinate systems connected to the plant bus
- System-wide time synchronization based on UTC (Universal Time Coordinated)

Technical specifications

Definitions

Process object (PO)	A process object (PO) is a synonym for an operable and observable block with approx. 30 to 50 individual OS variables (parameters). Thus the quantity framework data of the engineering system can be compared with those of the operating system.
OS variable	An OS variable or parameter is a defined memory location required for operating and monitoring with the operator system; values can be written into it and read from it (e.g. setpoint, actual value etc.). A PO usually has several OS variables (which can be operated and monitored).
Licensing	As of SIMATIC PCS 7 V7.0, the OS software will only be licensed on the basis of POs. This significantly simplifies calculation of the required license. An average of 50 OS variables will be calculated for a PO, where motors, valves etc. require fewer variables, and controls, dosing functions etc. require more variables. Checking of the license will also be carried out using the POs, and additionally includes checking of the total number of OS variables used. Every block fulfilling the following criteria is counted and calculated as a PO: <ul style="list-style-type: none"> • It is not a driver block. • It can be operated and monitored. • It can send messages.

Process objects	OS variables (approx.)
250	12500
1000	50000
2000	100000
3000	150000
5000	250000
8500	425000

OS quantity framework

Max. number of OS servers / pairs of servers	12
Max. number of automation systems per OS server / pair of servers	64
Max. number of OS clients in multi-client mode ¹⁾ (per multi-user system)	32
Max. number of monitors per operator station with multi-channel operation	4
Max. number of OS areas	64
Max. number of windows per monitor	1 to 16 (adjustable)
Number of trends per trend window	10
Selection time for OS area display (100 process symbols)	< 2 s
Max. number of process objects:	
• Per OS single station	5000 POs
• Per OS server	8500 POs
Max. number of configurable messages per server/single station	150.000
Number of process tags	
• Per OS single station	Approx. 3000
• Per OS server	Approx. 5000
• Per multi-user system	Approx. 60000

Integral high-performance archive system

(cyclic buffer), based on Microsoft SQL server, for:	
• Process value archiving (per OS server / single station)	Approx. 1000/s
• Message archiving (per OS server / single station)	Steady-state load approx. 10/s Message peak approx. 3000 / 4 s

Long-term archiving

• Process value archiving with StoragePlus	Process values from up to 4 single stations, servers or pairs of servers
- Process values of one server	Approx. 1000/s
- Process values of all servers	Approx. 1600/s
• Process value archiving with central archive server (CAS)	Process values from up to 11 servers or pairs of servers
- Process values of one server	Approx. 1000/s
- Process values of all servers	Approx. 10000/s

¹⁾ If every OS client has access to all OS servers/pairs of servers

Operator system

OS hardware

Introduction

Overview



All operator stations are based on modern SIMATIC PCS 7 industrial workstations optimized for use as OS single station, OS client or OS server. The SIMATIC PCS 7 industrial workstations are characterized by powerful PC technology combined with the Microsoft Windows XP Professional or Server 2003 operating system. They can be used in harsh industrial environments or also in offices.

Standard components and interfaces from the PC world offer generous scope for system-, customer- or sector-specific options and expansions.

The connection of as many as 4 process monitors via an optional multi-VGA graphics card in the OS single station or in the OS client permits the user-friendly control of several plant areas from one operator station.

Design

Single-user system (OS single station)

In a single-user system architecture, all operation and monitoring functions for a complete project (plant/unit) are concentrated in one station. A 10/100/1000 Mbit/s Ethernet RJ45 port is already onboard and can be used for connecting to an OS LAN (terminal bus). The OS single station can be linked to the Industrial Ethernet plant bus by means of two different network connections:

- CP 1613 A2 communications processor, for communication with max. 64 automation systems
- Standard FastEthernet network card and Basic Communication Ethernet for communication with max. 8 automation systems (not fault-tolerant systems)

The OS single station can be operated on the plant bus in parallel with other single-user systems or with a multi-user system architecture. Two OS single stations can, however, also be operated redundantly (SIMATIC PCS 7 single station redundancy).

Multi-user system with client/server architecture

A multi-user system consists of operator terminals (OS clients), which receive data (project data, process values, archives, alarms and messages) from one or more OS servers through an OS LAN (terminal bus). The OS LAN can share the transmission medium with the plant bus or it can be designed as a separate bus (Ethernet with TCP/IP).

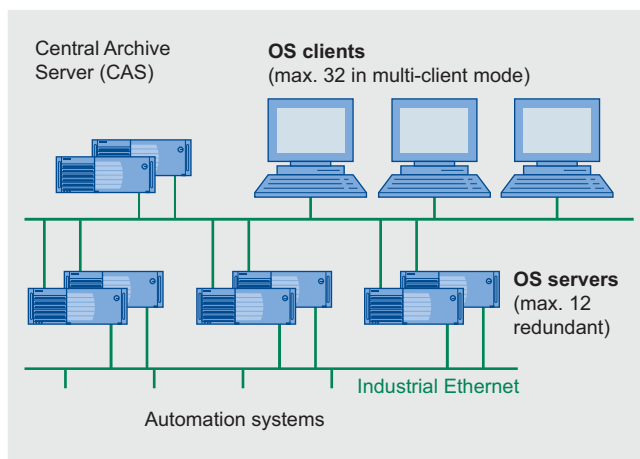

In this architecture, redundant OS servers may be set up to meet higher availability requirements. Critical applications running on the OS server are monitored by Health Check for software faults. If a fault is detected, switchover to the redundant system is triggered. Synchronization of the redundant OS servers takes place automatically and at high speed.

OS clients can access the data of not only one OS server/server pair, but from several OS servers/pairs of servers simultaneously (multi-client mode). This makes it possible to divide a plant into technological units and to distribute the data accordingly to several OS servers/pairs of servers. In addition to scalability, the advantage of distributed systems is the ability to decouple plant areas from each other, which results in higher availability.

SIMATIC PCS 7 supports multi-user systems with up to 12 OS servers or 12 redundant OS pairs of servers. In multi-client mode, OS clients can access data from one or more of the 12 OS servers/pairs of servers in parallel (up to 32 OS clients simultaneously on all).

The OS servers are designed in addition with client functions which permit them to access the data (archives, messages, tags, variables) from the other OS servers of the multi-user system. This means that process graphics on one OS server can also be linked with variables on other OS servers (area-independent displays).

Like the OS single stations, the OS servers can be connected to the Industrial Ethernet plant bus using a CP 1613 communications processor or a standard FastEthernet card with Basic Communication Ethernet (BCE). A 10/100/1000 Mbit/s Ethernet RJ45 port is already onboard and can be used for connecting to an OS LAN (terminal bus).

The CP 1613 communication integrated in the IE version of the ES/OS single station and the OS server is a combination of CP 1613 communications processor and S7-1613 communications software. When using fault-tolerant automation systems, the SIMATIC PCS 7 Workstation requires the S7-REDCONNECT software instead of the S7-1613 communications software. The S7-REDCONNECT Upgrade is suitable for upgrading the communications software (for ordering data, see page 9/28).

OS archiving

The operator system already includes a high-performance archiving system based on Microsoft SQL Server with cyclic archives for short-term saving of process values and messages/events (alarms). This short-term archive can be combined with a long-term archive on the basis of StoragePlus or the central archive server (CAS).

The StoragePlus provided for the bottom performance range is able to archive approx. 1600 process values/s from a total of 4 single stations/servers/pairs of servers. The powerful CAS satisfies much higher requirements. It can be configured as a single server or as a redundant pair of servers, and can archive approx. 10000 values/s from up to 11 servers/pairs of servers. The data managed in StoragePlus and in the CAS can be saved on all storage media supported by the operating system. This requires additional hardware and software, e.g. a DVD writer with suitable burning software.

The StoragePlus computer and the CAS are stations on the OS LAN (terminal bus), and are not connected to the plant bus. When using a SIMATIC PCS 7 Industrial Workstation as the hardware platform, the 10/100/1000 Mbit/s Ethernet RJ45 port already onboard can be used for connecting to the OS LAN.

Operator system

OS hardware

OS basic hardware

Overview

The complete range of SIMATIC PCS 7 Industrial Workstations is available for configuration of operating systems (see page 2/7).

Specially optimized versions of the SIMATIC PCS 7 Industrial Workstation are available for operation as single stations, servers or clients. The operating system and the following ES/OS software of the SIMATIC PCS 7 process control system are already preinstalled when delivered:

- Single station: PCS 7 Engineering Software for AS/OS (including OS Runtime software)
- Server: PCS 7 OS Software Server
- Client: PCS 7 OS Software Client

You need the corresponding licenses in order to use the pre-installed SIMATIC PCS 7 software.

Technical specifications

Detailed technical data for the single station, server and client versions of the SIMATIC PCS 7 Industrial Workstation can be found in Section "SIMATIC PCS 7 Industrial Workstation" of the Chapter "System-neutral components" in tabular format.

Selection and Ordering Data Order No.

OS single station

SIMATIC PCS 7 Industrial Workstation, single station version

Windows XP Professional MUI operating system (German, English, French, Italian, Spanish, Chinese)

• SIMATIC PCS 7 ES/OS 547B BCE WXP

Connection to plant bus with Ethernet network card RJ45 (PCI) 10/100/1000 Mbit/s and Basic Communication Ethernet (BCE) for up to 8 automation systems (not H-systems)

6ES7 650-0NF07-0YX0 D)

• SIMATIC PCS 7 ES/OS 547B IE WXP

Connection to plant bus with CP 1613 A2 communications processor

6ES7 650-0NF07-0YX1 D)

OS server

SIMATIC PCS 7 Industrial Workstation, server version

Windows Server 2003 MUI operating system (German, English, French, Italian, Spanish, Chinese)

• SIMATIC PCS 7 OS Server 547B BCE SRV03

Connection to plant bus with Ethernet network card RJ45 (PCI) 10/100/1000 Mbit/s and Basic Communication Ethernet (BCE) for up to 8 automation systems (not H-systems)

6ES7 650-0NH07-0YX0 D)

• SIMATIC PCS 7 OS Server 547B IE SRV03

Connection to plant bus with CP 1613 A2 communications processor

6ES7 650-0NH07-0YX1 D)

OS client

SIMATIC PCS 7 Industrial Workstation, client version

Windows XP Professional MUI operating system (German, English, French, Italian, Spanish, Chinese)

• SIMATIC PCS 7 OS Client 547B WXP

- without multi-VGA graphics card

6ES7 650-0NG07-0YX0 D)

- with Multi-VGA graphics card "2 Screens"

6ES7 650-0NG07-0YA0 D)

- with Multi-VGA graphics card "4 Screens"

6ES7 650-0NG07-0YB0 D)

D) Subject to export regulations: AL: N, ECCN: 5D992B1

Selection and Ordering Data Order No.**Upgrade from BCE to CP 1613 communication**

CP 1613 A2 PCI card for connection to Industrial Ethernet, with ITP and RJ45 connections	6GK1 161-3AA01	B)
--	-----------------------	----

SIMATIC NET S7-1613/2006 for Industrial Ethernet

S7 communication software for CP 1613, can be used with Windows 2000 Professional/2000 Server/XP Professional/Server 2003

Single license for 1 installation, runtime software, software and electronic manual on CD-ROM, license key on diskette, Class A, 2 languages (German/English)

6GK1 716-1CB64-3AA0**Expansion of communication software from S7-1613 to S7-REDCONNECT****SIMATIC NET S7-REDCONNECT Upgrade**

For communication with fault-tolerant AS systems, see page 9/28

Additional and expansion components

See page 2/15

B) Subject to export regulations: AL: N, ECCN: EAR99H

Note:

Ordering data in abbreviated form; for detailed Ordering data, see page 2/14.

Options

The basic hardware referred to may be expanded with the following options, depending on the customer's particular requirements and whether the hardware is used as OS single station, OS server or OS client, e.g. with:

- Hardware and software components for redundant operation
- Industrial LCD monitors for office and industry environments (see page 2/17)
- Signal module for audible and visual signaling of messages
- Chipcard reader for access protection (see page 2/4)

Multi-VGA operation with up to 4 process monitors is supported in the OS client by two additional hardware versions:

- SIMATIC PCS 7 OS Client 547B WXP with multi-VGA graphics card "2 Screens" and
- SIMATIC PCS 7 OS Client 547B WXP with multi-VGA graphics card "4 Screens"

OS clients and OS single stations with an integral standard graphic interface module for controlling a process monitor can also be functionally expanded by a multi-VGA graphics card "2 Screens" or "4 Screens" (see page 2/16 for ordering data).

Upgrading from BCE to CP 1613 communication

OS single stations and OS servers with BCE communication can be subsequently upgraded for communication with CP 1613. Items required:

- CP 1613 A2:
PCI card for connecting to Industrial Ethernet
- SIMATIC NET S7-1613:
S7 communications software for CP 1613

Operator system

OS hardware

Signal output

Overview

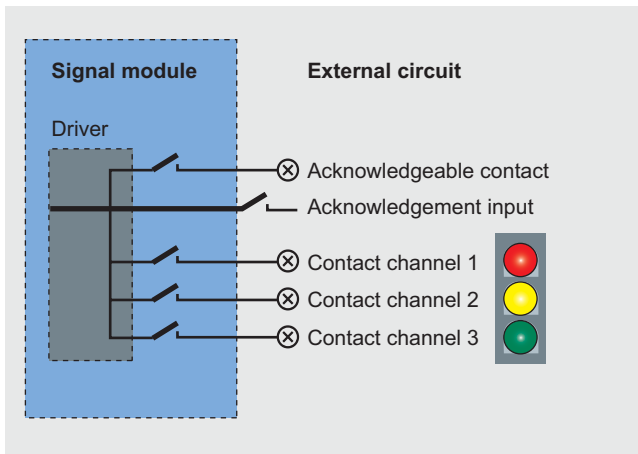

OS Single Station and OS Client can be expanded by a signal module. This signal module can operate a horn and up to 3 different lamps or buzzer sounds symbolizing different signal classes. Together with a hardware timer (watchdog) the signal module is able to detect and signal the failure of an operator station. A hardware acknowledge key can also be connected.

The signal module occupies one PCI slot in the operator station.

Selection and Ordering Data

Order No.

PCI Signal Module

PCI card for installing in an operator station

6DS1 916-8RR

B)

Connecting cable

For connecting an external audio detector to a signal module

- 3 m
- 10 m
- 32 m
- 50 m

6XV2 175-8AH30

6XV2 175-8AN10

6XV2 175-8AN32

6XV2 175-8AN50

B) Subject to export regulations: AL: N, ECCN: EAR99H

Overview

OS basic hardware and OS software are structured by OS single station, OS server and OS client in compliance with the architecture of the operator system and are accordingly coordinated in this regard.

Design

The OS standard software of OS single stations and OS clients can be expanded by SIMATIC PCS 7 SFC Visualization and Safety Matrix Viewer.

The high-performance cyclic buffer archiving system integrated as standard in OS single station and OS server for short-term archiving of up to 512 variables can be expanded within the limit of 10000 variables using SIMATIC PCS 7 archive licenses and SIMATIC PCS 7 Archive PowerPacks. The SIMATIC PCS 7 archive licenses (Count Relevant Licenses) are cumulative. SIMATIC PCS 7 Archive PowerPacks permit expansion in steps from 1500 to 5000 or 10000 variables. For ordering data for SIMATIC PCS 7 Archive and SIMATIC PCS 7 Archive PowerPacks, refer to page 5/20.

The short-term archive can also be combined with a long-term archive. StoragePlus is available for long-term archiving in the bottom performance range, and the central archive server (CAS) is envisaged for the top performance range. See page 5/19 for details.

You can also implement redundant system configurations with OS single stations and OS servers. See page 5/16 for details.

The following tables provide a selection aid for ordering an operator station. Depending on whether a redundant or non-redundant design is selected, the tables indicate the respectively required number of

- SIMATIC PCS 7 Industrial Workstations,
- licenses for OS standards software, and
- licenses for optionally used supplementary OS software.

Note on Microsoft SQL Server software

The "SQL Server" software from Microsoft delivered with SIMATIC PCS 7 may not be used outside the SIMATIC PCS 7 environment without the written approval of Siemens.

Single-user system

<i>OS single station with Windows XP Professional operating system</i>	Redundancy	
	Without	With

SIMATIC PCS 7 Industrial Workstation including operating system, alternatives

SIMATIC PCS 7 ES/OS 547B BCE WXP with BCE communication for up to 8 automation systems (not H systems)	1	2
SIMATIC PCS 7 ES/OS 547B IE WXP with Industrial Ethernet communication	1	2

Additional IE communications software for SIMATIC PCS 7 ES/OS 547B IE WXP

SIMATIC NET S7-REDCONNECT Upgrade	1	2
-----------------------------------	---	---

OS standard software

SIMATIC PCS 7 OS Software Single Station V7.0	1	--
SIMATIC PCS 7 Single Station Redundancy V7.0 including RS 232 connecting cable, 10 m	--	1

Supplementary OS software (optional)

SIMATIC PCS 7 SFC Visualization V7.0	1	2
SIMATIC Safety Matrix Viewer for PCS 7	1	2
SIMATIC PCS 7 Archive V7.0/ SIMATIC PCS 7 Archive PowerPack for expansion of short-term cyclic buffer archive	1	2

Multi-user system with client/server architecture

<i>OS server with Windows 2003 Server operating system</i>	Redundancy	
	Without	With

SIMATIC PCS 7 Industrial Workstation including operating system, alternatives

SIMATIC PCS 7 OS Server 547B BCE SRV03 with BCE communication for up to 8 automation systems (not H systems)	1	2
SIMATIC PCS 7 OS Server 547B IE SRV03 with Industrial Ethernet communication	1	2

Additional IE communications software for SIMATIC PCS 7 OS Server 547B IE SRV03

SIMATIC NET S7-REDCONNECT Upgrade	1	2
-----------------------------------	---	---

OS standard software

SIMATIC PCS 7 OS Software Server V7.0	1	--
PCS 7 Server Redundancy V7.0, including RS 232 connecting cable, 10 m	--	1

Supplementary OS software (optional)

SIMATIC PCS 7 Archive V7.0/ SIMATIC PCS 7 Archive PowerPack for expansion of short-term cyclic buffer archive	1	2
---	---	---

**OS client
with Windows XP Professional operating system****SIMATIC PCS 7 Industrial Workstation including operating system, alternatives**

Connection for OS-LAN (terminal bus) onboard: SIMATIC PCS 7 OS Client 547B WXP, alternatively with:	1	
<ul style="list-style-type: none"> • onboard standard graphics, • multi-VGA graphics card "2 Screens", or • multi-VGA graphics card "4 Screens" 		

OS standard software

SIMATIC PCS 7 OS Software Client V7.0	1	
---------------------------------------	---	--

Supplementary OS software (optional)

SIMATIC PCS 7 SFC Visualization V7.0	1	
SIMATIC Safety Matrix Viewer for PCS 7	1	

Operator system OS software

Introduction

Function

Graphical user interface

The predefined user interface of the operator system has all the features typical of a control system. It is multilingual, clearly structured, ergonomic and easy to understand. Operators can survey the process extremely easily, and rapidly navigate between different views of the plant. The system supports them in this process with hierarchical display structures that can be configured as required. These facilitate the direct selection of lower-level areas during process control.

Process displays and process tags can also be called up by name. An online language selector permits the user to change the display language during runtime.

A standard view and a server view are available for the technological representation of a plant, each with variously designed area overviews. Features provided in both views include:

- Message line for display of last message, can be configured such that either the message of the highest class or with the highest priority is shown
- Date, time and name of the operator
- Area overview with up to 36/49/64 areas (depending on resolution of the process monitor)
- Working area for plant displays and movable windows for faceplates, trends, messages etc.
- System function keys

In a special message view it is possible to switch between control message pages such as new list, old list, cleared alarm list, operator action list, control element list and message history list.

Trends

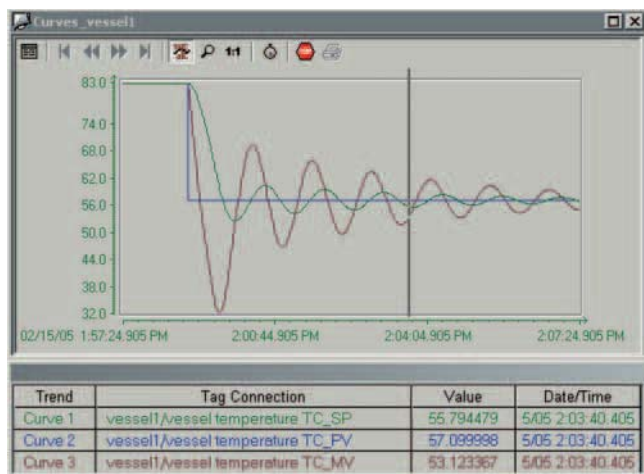

Trend window on the operator station

Trends can be displayed as a full-size picture or as a window in the working area, and printed directly. Some trends/trend groups are predefined during plant configuration. In particular for comparisons, standardized curves with percentage scaling can be produced in addition to the absolute display. The standard settings for dimensions and limits (e.g. minimum/maximum) defined during configuration are automatically applied during runtime. At runtime, operators can compose their own trends, select them by process tag name, and save them for reuse.

Messages and alarms

Up to 150,000 messages/alarms can be configured per OS single station/OS server.

Message priorities are issued as an additional attribute to the known signal classes in order to make it easier to assess large quantities of signals and to be better able to distinguish important messages from the less important.

By means of intelligent alarm management, alarms that are of lower importance for the safe and fault-free operation of the plant in certain plant states can be hidden and silenced. These alarms are still logged and archived as before. This saves a noticeable amount of work for the operators. Insignificant alarms can be hidden in two ways:

- Dynamically, i.e. depending on predefined definition for up to 32 operating states (Smart Alarm Hiding)
- Manually, with time limit

Operators can specifically disable messages (alarms) from individual process tags or from all process tags of a display/area in the event of faults in a sensor/actuator or during startup. Disabling and enabling are recorded in an input report.

Active messages are signaled by group displays representing predefined views based on message groups. The group displays also indicate whether messages are disabled or not.

The last message to have arrived – or the message with the highest priority when alarm priorities are utilized – is displayed at the top edge of the standard view. A predefined window with further messages can be called up with the "Extended message line".

The "Loop-in-alarm" and "Select display using process tag" functions support the quick evaluation and resolution of faults. Using "Loop-in-alarm", the operator can jump directly to the process display with the object which caused the fault, and can then call up the associated faceplate (loop display) through the process tag whose block symbol is colored (cyan). The faceplate window (loop display) can be anchored so that it remains visible even when the display is changed.

Flexible setting options for audible output and priorities which can be defined using signal variables additionally support the signaling of messages/alarms through a sound card or by controlling external horns via a signal module.

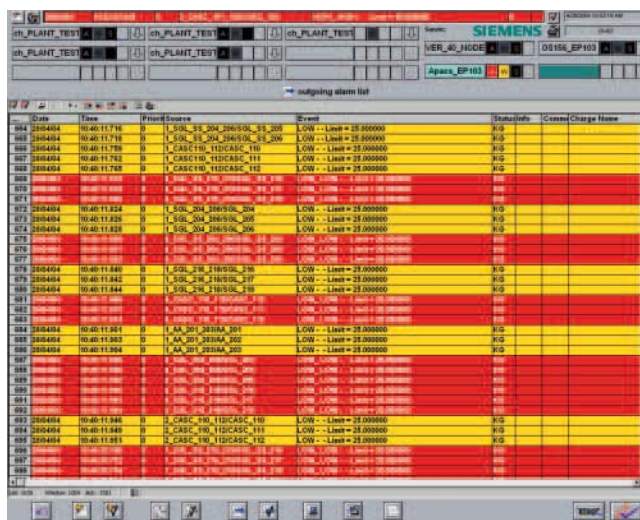

Message window on the operator station

Central user management, access control and electronic signature

With SIMATIC Logon, the operator system has central user administration with access control that complies with the validation requirements of 21 CFR Part 11. The administrator can divide the users into groups and assign differently defined access rights (roles) to these groups. The operator obtains the specific rights when logging on within the scope of the access control. Apart from the keyboard, an optional chipcard reader, for example, can be used as the logon device. In addition, SIMATIC Logon offers the "electronic signature" function.

SIMATIC Logon is already integrated in SIMATIC PCS 7 and need not be ordered separately. For further information on SIMATIC Logon as well as ordering data for an optional chipcard reader, see page 2/5.

Sign-of-life monitoring

With the "Sign-of-life monitoring" function, the operator system is able to monitor the correct operation of all subordinate systems connected to the plant bus. A graphical plant configuration display shows the status of each monitored component. The SIMATIC PCS 7 asset management offers enhanced functionality in this context (see Chapter "Asset Management").

Clock synchronization

SICLOCK TM central plant clock

Together with a SICLOCK time generator (see Catalog "Add Ons for SIMATIC PCS 7"), the operator system of the SIMATIC PCS 7 process control system can implement the system-wide synchronization on the basis of UTC (Universal Time Coordinated). This feature is especially beneficial for widely distributed plants present in different time zones, e.g. pipelines.

Script languages

Visual Basic and C are the scripting languages available for custom programming of OS applications.

Operator system

OS software

OS standard software for single station/server/client

Overview

The OS standard software is adapted to the SIMATIC PCS 7 Industrial Workstations offered (OS single station, OS server and OS client).

The OS standard software for OS single stations and OS servers can be adapted to plants of various size by means of the number of process objects (PO). The number of POs can be increased at any time by adding more PowerPacks in order to allow for higher requirements of system expansions.

You can also implement redundant system configurations with OS single stations and OS servers. See page 5/16 for details.

The engineering of the SIMATIC PCS 7 process control system is usually concentrated in a separate engineering system. In the case of OS single stations used for small plants, engineering and operator functionality can be combined in one station, except with redundant systems (for engineering software, see Section "Engineering system").

The high-performance cyclic buffer archiving system integrated as standard in OS single station and OS server for short-term archiving of up to 512 variables can be expanded to 1500, 5000 or 10000 variables using SIMATIC PCS 7 Archive PowerPacks. Furthermore, the variables of the SIMATIC PCS 7 archive itself can also be accumulated for the short-term archive within the expansion limit of 10000 variables (Count Relevant Licenses).

The short-term archive can also be combined with a long-term archive. See page 5/19 for details.

The OS standard software of OS single stations and OS clients can be expanded by SFC visualization and the safety matrix viewer.

Selection and Ordering Data Order No.

OS Software Single Station

SIMATIC PCS 7 OS Software Single Station V7.0

6 languages (German, English, French, Italian, Spanish, Chinese), executes with Windows XP Professional, single license for 1 installation

Electronic documentation on PCS 7 toolset DVD

Type of delivery:

License key disk, emergency key disk, certificate of license, terms and conditions;

PCS 7 V7.0 toolset DVDs, Microsoft SQL Server 2005 including EULA and supplementary CDs/DVDs (e.g. Microsoft ServicePacks and tools)

- 250 POs¹⁾
- 1000 POs
- 2000 POs
- 3000 POs
- 5000 POs

6ES7 658-2AA07-0YA0

6ES7 658-2AB07-0YA0

6ES7 658-2AC07-0YA0

6ES7 658-2AD07-0YA0

6ES7 658-2AE07-0YA0

SIMATIC PCS 7 OS Software Single Station PowerPack V7.0 for extending the OS Software Single Station

6 languages (German, English, French, Italian, Spanish, Chinese), executes with Windows XP Professional, single license for 1 installation

Type of delivery:

License key disk, emergency key disk, certificate of license, terms and conditions

- From 250 POs to 1000 POs
- From 1000 POs to 2000 POs
- From 2000 POs to 3000 POs
- From 3000 POs to 5000 POs

6ES7 658-2AB07-0YD0

6ES7 658-2AC07-0YD0

6ES7 658-2AD07-0YD0

6ES7 658-2AE07-0YD0

¹⁾ A process object (PO) is a synonym for an operable and observable block with approx. 30 to 50 individual OS variables (parameters). When licensing, an average of 50 OS variables is calculated for one PO.

Selection and Ordering Data Order No.**OS Software Server****SIMATIC PCS 7 OS Software Server V7.0**

6 languages (German, English, French, Italian, Spanish, Chinese), executes with Windows Server 2003, single license for 1 installation

Electronic documentation on PCS 7 toolset DVD

Type of delivery:

License key disk, emergency key disk, certificate of license, terms and conditions; PCS 7 V7.0 toolset DVDs, Microsoft SQL Server 2005 including EULA and supplementary CDs/DVDs (e.g. Microsoft ServicePacks and tools)

- 250 POs **6ES7 658-2BA07-0YA0**
- 1000 POs **6ES7 658-2BB07-0YA0**
- 2000 POs **6ES7 658-2BC07-0YA0**
- 3000 POs **6ES7 658-2BD07-0YA0**
- 5000 POs **6ES7 658-2BE07-0YA0**
- 8500 POs **6ES7 658-2BF07-0YA0**

SIMATIC PCS 7 OS Software Server PowerPack V7.0
for extending the OS Software Server

6 languages (German, English, French, Italian, Spanish, Chinese), executes with Windows Server 2003, single license for 1 installation

Type of delivery: License key disk, emergency key disk, certificate of license, terms and conditions

- From 250 POs to 1000 POs **6ES7 658-2BB07-0YD0**
- From 1000 POs to 2000 POs **6ES7 658-2BC07-0YD0**
- From 2000 POs to 3000 POs **6ES7 658-2BD07-0YD0**
- From 3000 POs to 5000 POs **6ES7 658-2BE07-0YD0**
- From 5000 POs to 8500 POs **6ES7 658-2BF07-0YD0**

Selection and Ordering Data Order No.**OS Software Client****SIMATIC PCS 7 OS Software Client V7.0**

6 languages (German, English, French, Italian, Spanish, Chinese), executes with Windows XP Professional, floating license for 1 user

Electronic documentation on PCS 7 toolset DVD

Type of delivery:

License key disk, emergency key disk, certificate of license, terms and conditions; PCS 7 V7.0 toolset DVDs, Microsoft SQL Server 2005 including EULA and supplementary CDs/DVDs (e.g. Microsoft ServicePacks and tools)

6ES7 658-2CX07-0YA5

Operator system

OS software

SFC Visualization

Overview

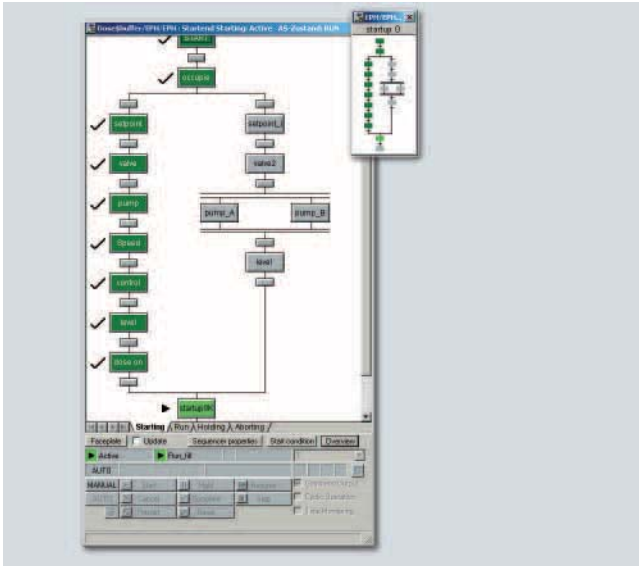

The SFC visualization function of the operator system enables you to display and operate the sequence controls configured with the SFC tool in the same way as on the engineering system. No additional configuration work is necessary.

In an overview display it is possible, for example, to open step and transition displays and to present step comments or dynamically supplied stepping conditions.

Selection and Ordering Data

Order No.

SIMATIC PCS 7 SFC Visualization V7.0

For displaying and operating SFC sequence controls on an operator station

6 languages (German, English, French, Italian, Spanish, Chinese), executes with Windows XP Professional or Windows Server 2003, floating license for 1 user

Type of delivery:
License key disk, emergency key disk, certificate of license, terms and conditions

6ES7 652-0XD07-2YB5

Overview

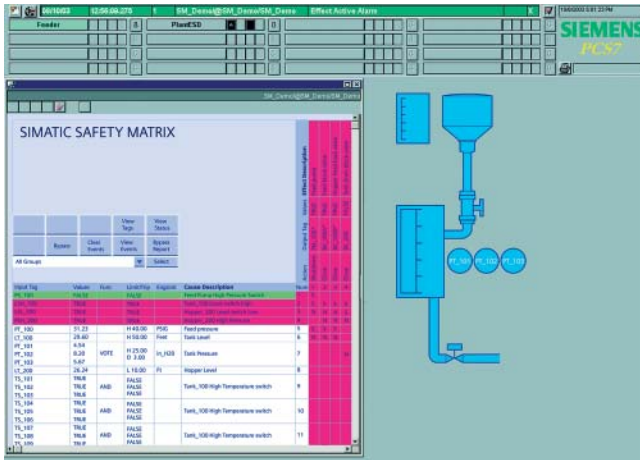

Using the SIMATIC Safety Matrix Viewer, you can operate and monitor the SIMATIC Safety Matrix from the SIMATIC PCS 7 OS Single Station or from the SIMATIC PCS 7 OS Client.

The SIMATIC Safety Matrix Viewer is available together with the SIMATIC PCS 7 OS software as a low-price SIMATIC PCS 7 Safety Matrix OS Package. The difference is in the SIMATIC PCS 7 OS software which depends on whether the OS Single Station or the OS Client is the target system.

By means of the SIMATIC PCS 7 Safety Matrix OS Extension Package, a SIMATIC PCS 7 OS Single Station or a SIMATIC PCS 7 OS Client can be subsequently expanded by the SIMATIC Safety Matrix Viewer.

Details on the SIMATIC Safety Matrix as well as information on SIMATIC PCS 7 Safety ES Packages can be found from page 4/20.

Selection and Ordering Data

Order No.

SIMATIC PCS 7 Safety Matrix OS Single Station Package

Executes with Windows XP Professional, single license for 1 installation

Combination of:

- SIMATIC PCS 7 OS Software Single Station for 250 POs, 6 languages (German, English, French, Italian, Spanish, Chinese)
- SIMATIC Safety Matrix Viewer, 1 language (English)

6ES7 652-6AA07-0YA0

SIMATIC PCS 7 Safety Matrix OS Client Package

Executes with Windows XP Professional, floating license for 1 user

Combination of:

- SIMATIC PCS 7 OS Software Client, 6 languages (German, English, French, Italian, Spanish, Chinese)
- SIMATIC Safety Matrix Viewer, 1 language (English)

6ES7 652-6CX07-0YA5

SIMATIC PCS 7 Safety Matrix OS Extension Package

Executes with Windows XP Professional, floating license for 1 user

comprising: SIMATIC Safety Matrix Viewer, 1 language (English)

6ES7 652-6BX07-0YA5

Operator system

Redundant operator systems

OS redundancy

5

Overview

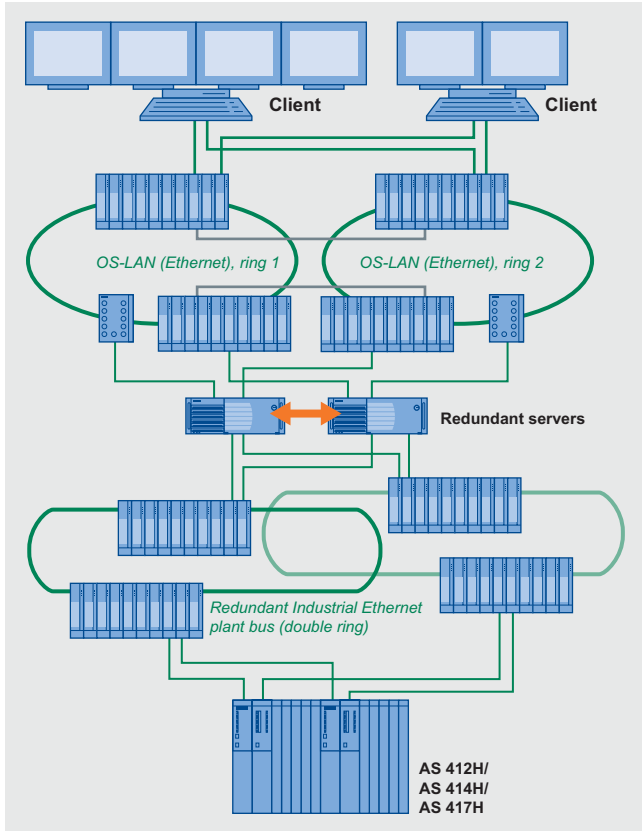

OS redundancy shown in a client/server architecture with high availability OS single stations and OS servers can have a redundant design if necessary:

- A SIMATIC PCS 7 Single Station Redundancy programming package is required to design redundant OS single stations. This contains:
 - OS Software Single Station
 - Software WinCC/Redundancy (in each case for two OS single stations)
 - RS 232 cable connector for optimization of internal communication between the two OS single stations.
- A SIMATIC PCS 7 Server Redundancy programming package is required to design redundant OS servers. This contains:
 - OS Software Server
 - Software WinCC/Redundancy (in each case for two OS servers)
 - RS 232 cable connector for optimization of internal server-server communication.

A separate Ethernet connection can be used instead of the serial RS 232 connection for optimization of internal communication between the two redundant stations (OS single stations/OS servers). This is an alternative e.g. with larger distances between the stations or if the COM interface is required elsewhere.

An optical or electrical connection can be used depending on the environmental conditions and the distance between the redundant stations, e.g. up to 100 m per crossover network cable with RJ45 connectors. For further information, refer to the Manual "SIMATIC PCS 7 V7.0 fault-tolerant process control systems"; for appropriate cable material and further accessories, refer to Catalog IK PI (Industrial Communication).

What further components are required depends on the plant architecture. The design of the plant bus and terminal bus (OS-LAN) is of particular importance, as well as the type and number of subordinate automation systems. The maximum requirements are determined by the redundant configuration shown in the figure with a fault-tolerant automation system and two redundant rings each for the plant bus and terminal bus.

Design

The following table provides an overview of which components are required for a redundant OS single station or OS pair of servers depending on certain criteria:

		Up to 8 AS per single station/pair of servers	9 to 64 AS per single station/pair of servers	Min. 1 fault-tolerant AS	
SIMATIC PCS 7 Industrial Workstation, single station or server version, alternatives	Incl. Ethernet network card 10/100/1000 Mbit/s and BCE	2	--	--	
	Incl. CP 1613 and S7-1613 software	2 (alternative to BCE)	2	2	
SIMATIC PCS 7 Single Station/Server Redundancy V7.0 (including RS 232 connecting cable)		1	1	1	
S7-REDCONNECT Upgrade		--	--	2	
Connection to redundant plant bus (2 rings), alternatives	BCE	Desktop adapter network card	2	--	
	CP 1613	CP 1613 communications processor	2 (alternative to BCE)	2	
		S7-1613 software	2 (alternative to BCE)	2	--
		S7-REDCONNECT software	--	--	2
Connection to redundant terminal bus (2 rings)	SIMATIC PCS 7 Redundant Terminalbus Adapter Package		2	2	

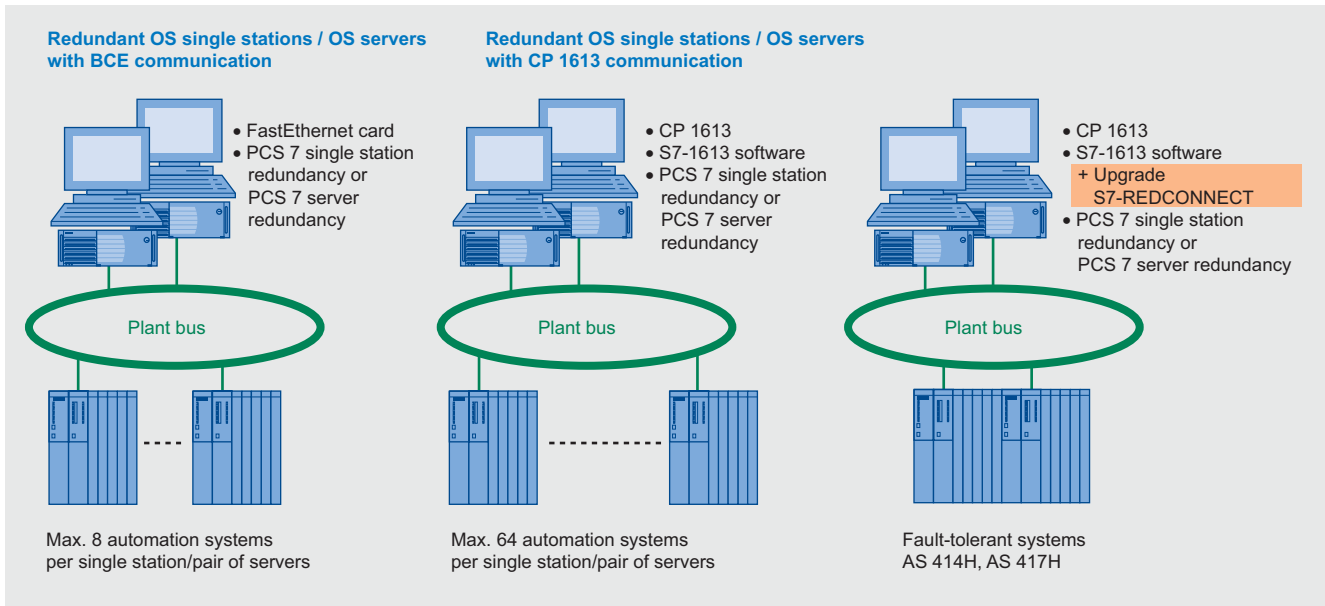

Connection of redundant OS single stations / OS servers on the plant bus

Connection to plant bus

The operator systems (single stations or servers) communicate with the automation systems via the Industrial Ethernet plant bus. The following special points must be observed for redundant configurations:

- BCE communication via Ethernet network card 10/100/1000 Mbit/s is generally also sufficient for redundant operator stations. Up to 8 automation systems can be connected per pair of servers in this manner.
- Communication using CP 1613 is only required in the following cases:
 - Connection of a subordinate fault-tolerant automation system
 - More than 8 stations are required per OS.
- An operator station with CP 1613 is delivered with the S7-1613 software. If a subordinate fault-tolerant automation system is to be connected, the S7-REDCONNECT software is required. In this case, the S7-REDCONNECT upgrade must be ordered.
- If an operator station with BCE communication is to be upgraded for operation with a subordinate fault-tolerant automation system, the S7-REDCONNECT software is required in addition to the CP 1613 communications processor.
- If the plant bus is to be designed as a redundant dual ring, you require two interface modules (2 x Ethernet network cards 10/100/1000 Mbit/s or 2 x CP 1613) per OS single station / OS server.

Connection to terminal bus (OS-LAN)

You can connect clients and servers to a non-redundant terminal bus (OS-LAN) using the onboard Ethernet interface or a desktop adapter network card. With a redundant terminal bus where two rings are connected together via two pairs of switches, each station must be connected to both rings using a SIMATIC PCS 7 redundant terminal bus adapter package. The SIMATIC PCS 7 redundant terminal bus adapter package consists of server and desktop adapter network cards (for details on the configuration, refer to the Manual "SIMATIC PCS 7 V7.0 fault-tolerant process control systems").

Selection and Ordering Data

Order No.

Design of redundant OS single stations

SIMATIC PCS 7 Single Station Redundancy V7.0

6 languages (German, English, French, Italian, Spanish, Chinese), executes with Windows XP Professional, single license for 2 installations with OS Software Single Station and WinCC/Redundancy as well as RS 232 connecting cable, 10 m
 Type of delivery:
 2 license key disks, 2 emergency key disks, certificate of license, terms and conditions; PCS 7 V7.0 toolset DVDs, Microsoft SQL Server 2005 including EULA, supplementary CDs/DVDs (e.g. Microsoft ServicePacks and tools) as well as RS 232 connecting cable, 10 m

- 250 POs
- 1000 POs
- 2000 POs
- 3000 POs
- 5000 POs

PowerPacks for PO expansion

See under OS Software Single Station PowerPack V7.0 (2 PowerPacks each required)

6ES7 652-3AA07-2YA0

6ES7 652-3AB07-2YA0

6ES7 652-3AC07-2YA0

6ES7 652-3AD07-2YA0

6ES7 652-3AE07-2YA0

Operator system

Redundant operator systems

OS redundancy

Selection and Ordering Data

Order No.

Design of redundant OS servers

SIMATIC PCS 7 Server Redundancy V7.0

6 languages (German, English, French, Italian, Spanish, Chinese), executes with Windows Server 2003, single license for 2 installations with OS Software Server und WinCC/Redundancy as well as RS 232 connecting cable, 10 m

Type of delivery:
2 license key disks, 2 emergency key disks, certificate of license, terms and conditions; PCS 7 V7.0 toolset DVDs, Microsoft SQL Server 2005 including EULA, supplementary CDs/DVDs (e.g. Microsoft ServicePacks and tools) as well as RS 232 connecting cable, 10 m

- 250 POs **6ES7 652-3BA07-2YA0**
- 1000 POs **6ES7 652-3BB07-2YA0**
- 2000 POs **6ES7 652-3BC07-2YA0**
- 3000 POs **6ES7 652-3BD07-2YA0**
- 5000 POs **6ES7 652-3BE07-2YA0**
- 8500 POs **6ES7 652-3BF07-2YA0**

PowerPacks for PO expansion

See under OS Software Server PowerPack V7.0 (2 PowerPacks each required)

Individual components for redundancy upgrading with existing OS single stations / OS servers

WinCC/Redundancy V6.2

For alignment of archives following OS restart; single license for 2 installations
Installation required on each of the two redundant SIMATIC PCS 7 Industrial Workstations

6AV6 371-1CF06-2AX0

RS 232 connecting cable, 10 m

6ES7 902-1AC00-0AA0

Expansion components for OS single stations / OS servers

For connection to redundant plant bus (BCE/CP 1613), for upgrading from BCE to CP 1613 including communication with fault-tolerant AS

Desktop adapter network card

for BCE and as spare part for redundant terminal bus
INTEL PCI network card for connection to Industrial Ethernet (10/100/1000 Mbit/s), with RJ45 connection

A5E00504378 B)

CP 1613 A2

PCI card for connection to Industrial Ethernet, with ITP and RJ45 connections

6GK1 161-3AA01 B)

SIMATIC NET S7-1613/2006 for Industrial Ethernet

S7 communications software for CP 1613, runtime software, in 2 languages (German, English), executes with Windows 2000 Professional/ 2000 Server/ XP Professional/ Server 2003, single license for 1 installation, software and electronic manual on CD-ROM, license key on diskette

6GK1 716-1CB64-3AA0

Selection and Ordering Data

Order No.

Communications software when using fault-tolerant AS

To be used instead of the S7-1613 software

SIMATIC NET S7-REDCONNECT/2006

Software for fail-safe S7 communication over redundant networks, for CP 1613, runtime software, in 2 languages (German, English), executes with Windows 2000 Professional/ 2000 Server/ XP Professional/ Server 2003, single license for 1 installation, software and electronic manual on CD-ROM, license key on diskette

6GK1 716-0HB64-3AA0

Upgrading for communication with fault-tolerant AS

Starting from OS single stations / OS servers with CP 1613 and S7-1613 software

SIMATIC NET S7-EDCONNECT/2006 Upgrade

Software for expansion of S7-1613 to S7-REDCONNECT, runtime software, in 2 languages (German, English), executes with Windows 2000 Professional/ 2000 Server/ XP Professional/ Server 2003, single license for 1 installation, software and electronic manual on CD-ROM, license key on diskette

6GK1 716-0HB64-3AC0

Components for connection of OS single

stations/OS servers/OS clients to a redundant terminal bus

SIMATIC PCS 7 Redundant Terminal Bus Adapter Package

Server and desktop adapter for designing a redundant terminal bus, consisting of 2 Intel PCI network cards for connection to Industrial Ethernet (10/100/1000 Mbit/s), with RJ45 connection

6ES7 652-0XX01-1XF0 B)

B) Subject to export regulations: AL: N, ECCN: EAR99H

Overview

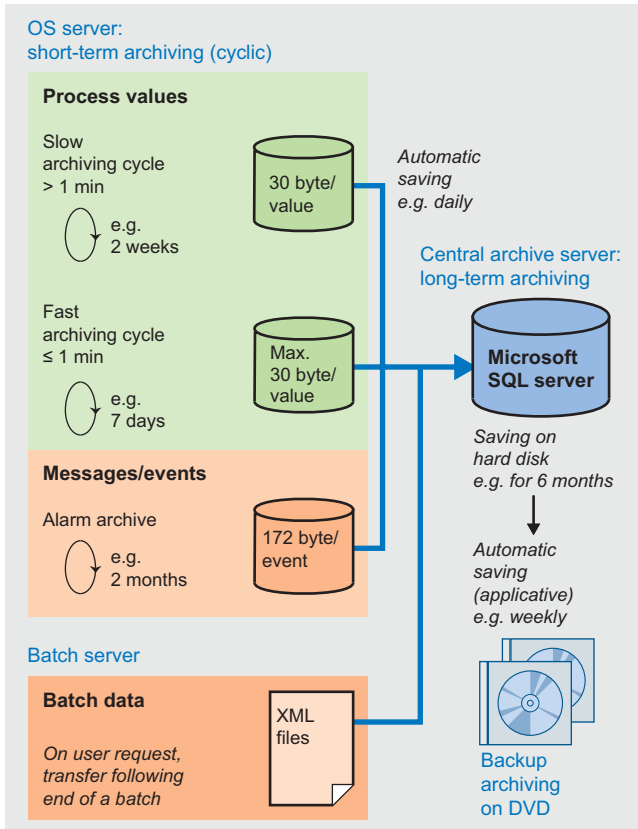

Overview of short-term and long-term archiving

The operator system already includes a high-performance archiving system based on Microsoft SQL Server with cyclic archives for short-term saving of process values (typically 1 to 4 weeks) and messages/events (typically 2 months). Data from the short-term archive as well as OS reports and batch data from SIMATIC BATCH can be exported time-controlled or event-controlled for permanent archiving in a long-term archive.

Design

Two alternatives with different features are available for the OS long-term archiving:

- **StoragePlus:** More economical version for the lower performance range; for the archiving of about 1600 values/s from as many as four single stations, servers or pairs of servers
- **Central archive server (CAS),** for single or redundant configuration: High-performance version for archiving about 10000 values/s from as many as 11 servers or pairs of servers

During long-term archiving with StoragePlus, the archived data can be visualized by means of the StoragePlus viewer. Process values and messages exported to the central archive server can also be accessed from an OS client.

The data managed in StoragePlus and in the central archive server can be saved on commercially available storage media (e.g. DVD). This requires additional hardware and software which support the respectively used operating system, e.g. a DVD writer with appropriate writer software.

The StoragePlus computer and the central archive server are stations on the terminal bus, and are not connected to the plant bus. When using a SIMATIC PCS 7 Industrial Workstation (BCE version) as the hardware platform, the Ethernet interface (Ethernet RJ45 port) already onboard can be used for connecting to the terminal bus.

Through a redundant design of the central archive server, the availability of long-term data is increased, and these can also be accessed by the OS clients or the OpenPCS 7 station. SIMATIC BATCH does not yet swap out the batch data to the two central archive servers. However, following automatic matching of the archives, the batch data are available on both central archive servers following swapping out.

Function

Features of the archive variables and licensing of short-term and long-term archiving

- There is only one type of archive variable for OS short-term archiving and CAS long-term archiving. SIMATIC PCS 7 Archive and SIMATIC PCS 7 Archive PowerPacks can be used universally - both for the operator system and for the CAS.
- The "SIMATIC PCS 7 Archives" are Count Relevant Licenses, i.e. the archive variables of several licenses are cumulative. Starting with the smallest cumulative number of 1500 variables, any combinations are possible with consideration of the expansion limits of 10000 variables for OS short-term archiving and 120000 variables for CAS long-term archiving, e.g. 2 x 1500 or 1 x 1500 with 1 x 5000 variables.
- The number of archive variables can also be increased using "SIMATIC PCS 7 Archive PowerPacks". Starting with 1500 variables, increasing is possible in steps through 5000, 10000, 30000 and 80000 variables up to 120000 variables.
- If a CAS is not used, the licenses of the SIMATIC PCS 7 Archive are installed on the OS single stations and OS servers of the system. Otherwise the installation is only on the CAS. OS single stations and OS servers then "book" their archive variables from the CAS's stock of variables. It is therefore unnecessary to carry out the complex installation of archive variable licenses on all OS single stations and OS servers in the system.
- Operator systems (OS single stations and OS servers) are assigned 512 archive variables each by the OS software, the CAS is immediately provided with 1500 archive variables by the central archive server basic package. If the short-term archiving of the operator systems is combined with the CAS long-term archiving, the 512 archive variables of the OS single stations and OS servers are not cumulated with the 1500 archive variables of the CAS. The 1500 archive variables of the CAS are then available universally for short-term and long-term archiving.
- In the case of redundant systems, two archives must be configured with the corresponding number of archive variables.

Operator system

OS archiving

OS short-term archiving

Overview

An integral component of the OS software of OS single stations and OS servers is a high-performance archiving system which can be configured during runtime and which is based on Microsoft SQL server technology. It is used to record process data (typical period 1 to 4 weeks) and messages/events (typical period 2 months) in cyclic archives.

The data from the short-term archive as well as OS reports and batch data from SIMATIC BATCH can be exported time-controlled or event-controlled for permanent archiving in StoragePlus or in a central archive server (CAS).

Commencing with the 512 archive variables present in the system, the short-term archive for process data can be expanded within the limit of 10000 archive variables with accumulated SIMATIC PCS 7 archives (Count Relevant Licenses) or SIMATIC PCS 7 Archive PowerPacks. The archive variables can be expanded in steps from 1500 to 5000 or 10000 variables using SIMATIC PCS 7 Archive PowerPacks.

Further information on licensing, in particular in combination with long-term archiving per CAS, can be found at page 5/19 under "Features of archive variables and licensing of short-term and long-term archiving".

Selection and Ordering Data Order No.

Expansion of integral high-performance cyclic buffer archive (512 variables) of OS Single Station and OS Server

SIMATIC PCS 7 Archive V7.0

6 languages (German, English, French, Italian, Spanish, Chinese), executes with Windows XP Professional or Windows Server 2003, single license for 1 installation (Count Relevant License)

Type of delivery:
License key disk, emergency key disk, certificate of license, terms and conditions

- 1500 variables
- 5000 variables
- 10000 variables

6ES7 658-2EA07-2YB0

6ES7 658-2EB07-2YB0

6ES7 658-2EC07-2YB0

SIMATIC PCS 7 Archive PowerPack V7.0

6 languages (German, English, French, Italian, Spanish, Chinese), executes with Windows XP Professional or Windows Server 2003, single license for 1 installation

Type of delivery:
License key disk, emergency key disk, certificate of license, terms and conditions

- For expansion from 1500 to 5000 variables
- For expansion from 5000 to 10000 variables

6ES7 658-2EB07-2YD0

6ES7 658-2EC07-2YD0

Overview

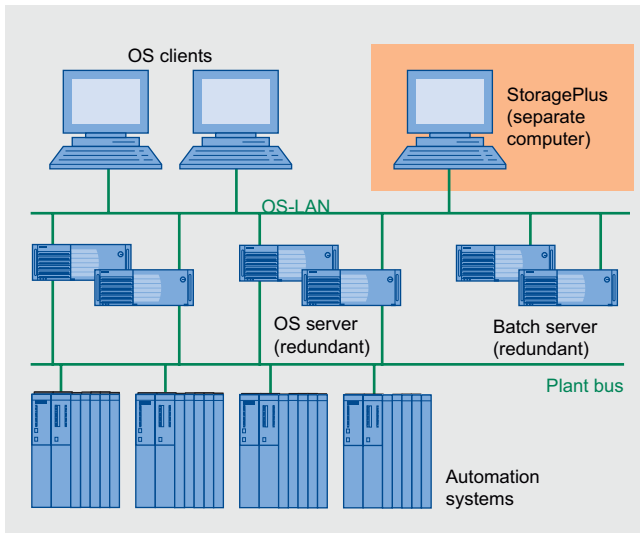

StoragePlus is a program package for long-term archiving of

- OS archive data (process values and messages),
- OS reports and
- batch data of the SIMATIC PCS 7 process control system.

StoragePlus manages the process values and messages exported from the OS archives, the OS reports as well as batch data from SIMATIC BATCH in a central database. All these data can be visualized in a graphic and clear manner using the Internet Explorer.

Application

StoragePlus can be used for long-term archiving of process values and messages, OS reports and SIMATIC BATCH data from up to 4 single stations/servers/pairs of servers of the SIMATIC PCS 7 V7.0 process control system. For this purpose StoragePlus has to be installed on a separate computer with Windows XP Professional oder Windows Server 2003 (see page 2/14) which is connected by terminal bus to the OS and batch servers/single stations of the SIMATIC PCS 7 system.

Function

StoragePlus manages the process values, messages and OS reports which are swapped out of the OS archives, as well as batch data from SIMATIC BATCH, in a central database and makes these data available independent of the PCS 7 runtime systems:

- All data can be visualized in a graphic and clear manner using the Internet Explorer, selection of the data is selected by integrated filter functions.
- Messages and process values can be shown in table form, and process values also in graphic form.
- Tables of process values can be exported in CSV format for processing in other Windows applications, e.g. Microsoft Excel.

The data managed by StoragePlus and the cataloging can be swapped out onto all commercially available storage media. You require additional hardware and software for this which support the StoragePlus operating system, e.g. DVD writer with appropriate writer software.

StoragePlus is able to read in data which were swapped out using StoragePlus V1.0 / V1.1 and to convert the data into the SIMATIC PCS 7 V7.0 (StoragePlus V1.2) data format.

Overview of functions

- Archiving of messages, process values and reports of the SIMATIC PCS 7 V7.0-operator systems
- Archiving of batch data from SIMATIC BATCH V7.0
- Cataloging of all StoragePlus data
- Swapping out of all StoragePlus data as well as the cataloging onto external storage media
- Reading-in of the swapped-out StoragePlus data and cataloging from external storage media
- Parameterizing of views (display windows and masks) including the selection criteria for displaying the data
- Visualizing of messages in table form dependent on filter functions
- Displaying of process values in table or graphic form dependent on filter functions
- Exporting of process values in CSV format, e.g. to Microsoft Excel
- Visualizing a batch overview (selecting the detailed protocol of a batch from the batch overview is possible)
- Web-based presentation of data
- Access protection with user-specific rights
- Migration of messages and measurement values from StoragePlus V1.0 / V1.1

Operator system

OS archiving

OS long-term archiving with StoragePlus

Technical specifications

StoragePlus

Long-term archiving	Up to 4 single stations, servers or pairs of servers simultaneously
Data input for process-value archiving by one server	Approx. 1000/s
Data input for process-value archiving by all servers	Approx. 1600/s
Max. data volume input per day	500 MB

Hardware requirements

Main memory	512 MB or more, 2 GB recommended
Hard disk memory recommended	
• Security	EIDE-RAID 1 with 2 hard disks for 80 GB or more
• Capacity	2 hard disks for 80 GB or more for separating database and log files

Software requirements

Operating system / applications	<ul style="list-style-type: none"> • Microsoft Windows XP Professional including SP2 or Windows Server 2003 including SP1 • Microsoft Internet Explorer V6.0 including SP1 • Microsoft Internet Information Services (IIS) and installed Message Queuing
Software required for StoragePlus from the scope of delivery of SIMATIC PCS 7; when used for StoragePlus, no additional licenses are required.	<ul style="list-style-type: none"> • Microsoft SQL Server 2005 • OS client SIMATIC PCS 7 V7.0 • Client software SIMATIC BATCH V7.0

Selection and Ordering Data

Order No.

SIMATIC StoragePlus V1.2

Software for long-term archiving of data from up to 4 single stations, servers or pairs of servers

4 languages (German, English, French, Chinese), executes with Windows XP Professional or Windows Server 2003, single license for 1 installation

Type of delivery:
License key disk, emergency key disk, certificate of license, terms and conditions

6ES7 652-0XC21-2YB0

Overview

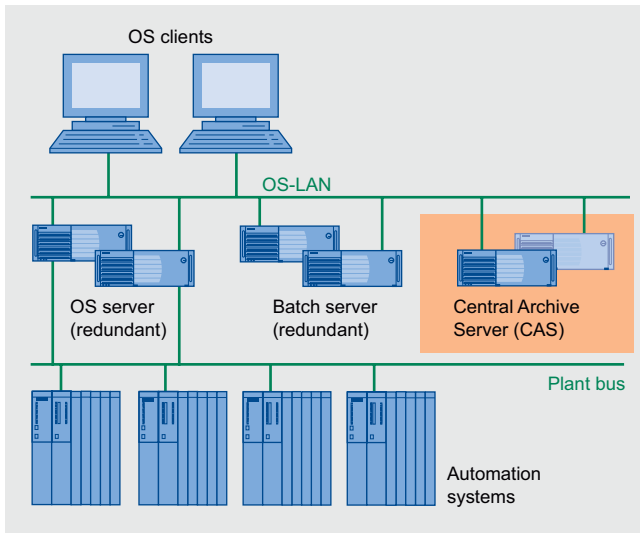

The central archive server (CAS) can be used for long-term archiving of

- OS archive data (process values and messages),
- OS reports and
- batch data of the SIMATIC PCS 7 process control system.

The process values and messages exported from the OS archives, as well as the OS reports and batch data from SIMATIC BATCH are managed by the CAS in a central database. They can be visualized directly on the OS clients or with the Storage-Plus viewer of the CAS.

Design

The SIMATIC PCS 7 OS Server (BCE version) with the Microsoft Windows Server 2003 operating system offered in Section "SIMATIC PCS 7 Industrial Workstation" in the Chapter "System-neutral components" can be used as the basic hardware for the CAS. The OS Software server of the SIMATIC PCS 7 V7.0 process control system is preinstalled on this basic device in addition to the operating system. The Central Archive Server Basic Package is required to configure the CAS. This can be extended to a maximum of 120000 archive variables using SIMATIC PCS 7 Archive/SIMATIC PCS 7 Archive PowerPack licenses. Detailed information on licensing of the CAS in combination with OS short-term archiving can be found at page 5/19 under "Features of archive variables and licensing of short-term and long-term archiving".

The CAS does not require a connection to the plant bus. It can be connected to the OS and batch servers of the SIMATIC PCS 7 plant via OS-LAN (terminal bus), e.g. via the integral network connection (Ethernet RJ45 port onboard) of the server.

Redundant design of central archive server

The CAS can also have a redundant design. This increases the availability of long-term data, and these can also be accessed by the OS clients or the OpenPCS 7 station. SIMATIC BATCH does not yet swap out the batch data to the two central archive servers. However, following automatic matching of the archives, the batch data are available on both central archive servers following swapping out.

The following table shows the corresponding number of components required for single and redundant CAS configurations.

	Single central archive server (CAS)	Redundant central archive server (CAS)
SIMATIC PCS 7 Industrial Workstation, server version Incl. Ethernet network card and BCE	1	2
Central archive server basic package	1	2
SIMATIC PCS 7 Archives/SIMATIC PCS 7 Archive PowerPacks for additional archive variables	Licenses for one server	Licenses for two servers
WinCC option "Redundancy"	--	1
RS 232 connecting cable, 10 m	--	1

Instead of the serial RS 232 connection, it is also possible to use a separate Ethernet connection for optimization of internal communication between the redundant central archive servers, e.g. as an alternative for larger distances.

Operator system

OS archiving

OS long-term archiving with Central Archive Server

Function

The central archive server (CAS) can archive approx. 10000 process values/s from as many as 11 servers or pairs of servers of the SIMATIC PCS 7 V7.0 process control system. It is configured in a SIMATIC PCS 7 project like other stations of the SIMATIC PCS 7 process control system (e.g. OS server, batch server, route control server, all clients or OpenPCS 7 station).

The process values and messages managed in the database of the CAS can be visualized clearly on the OS clients. The StoragePlus Viewer of the CAS can be used for data visualization on the OS single station. Data selection is supported by integrated filter functions. Messages and process values can be shown in table form, and process values also in graphic form. Tables of process values can be exported in CSV format for processing in other Windows applications, e.g. Microsoft Excel.

The data managed by CAS and the cataloging can be swapped out onto all commercially available storage media. This requires additional hardware and software which support the CAS operating system, e.g. a DVD writer with appropriate writer software. Swapping-out can be initiated either by an operator input or when a certain amount of the hard disk is full.

Overview of functions

- Archiving of messages, process values and reports of the SIMATIC PCS 7 V7.0-operator systems
- Archiving of batch data from SIMATIC BATCH V7.0
- Cataloging of all data
- Swapping out of all data as well as cataloging onto external storage media
- Reading-in of the swapped-out data and cataloging from external storage media
- Data visualization on the OS clients:
 - Parameterizing of views (display windows and masks) including the selection criteria for displaying the data
 - Visualizing of messages in table form dependent on filter functions
 - Displaying of process values in table or graphic form dependent on filter functions
 - Visualizing a batch overview (selecting the detailed protocol of a batch from the batch overview is possible)
- Exporting of process values in CSV format, e.g. to Microsoft Excel
- Access protection with user-specific privileges, also using SIMATIC logon
- Configurable redundancy mode

Technical specifications

Central archive server (CAS)

Long-term archiving	Up to 11 servers/server pairs simultaneously
Data input for process-value archiving by one server	Approx. 1000/s
Data input for process-value archiving by all servers	Approx. 10000/s
Message input by one server (limited by the performance of short-term archiving)	Steady-state load approx. 10/s Message peak approx. 3000/4 s

Selection and Ordering Data

Order No.

Central archive server (CAS)

Central Archive Server Basic Package V7.0, including 1500 variables

Can be expanded by SIMATIC PCS 7 Archives/SIMATIC PCS 7 Archive PowerPacks to up to 120000 variables; 6 languages (German, English, French, Italian, Spanish, Chinese), executes with Windows Server 2003, single license for 1 installation
Type of delivery: License key disk, emergency key disk, certificate of license, terms and conditions

6ES7 658-2FA07-0YB0

SIMATIC PCS 7 Archive V7.0

6 languages (German, English, French, Italian, Spanish, Chinese), executes with Windows XP Professional or Windows Server 2003, single license for 1 installation (Count Relevant License)

Type of delivery: License key disk, emergency key disk, certificate of license, terms and conditions

- 1500 variables
- 5000 variables
- 10000 variables
- 30000 variables
- 80000 variables
- 120000 variables

6ES7 658-2EA07-2YB0

6ES7 658-2EB07-2YB0

6ES7 658-2EC07-2YB0

6ES7 658-2ED07-2YB0

6ES7 658-2EE07-2YB0

6ES7 658-2EF07-2YB0

SIMATIC PCS 7 Archive Power-Pack V7.0

6 languages (German, English, French, Italian, Spanish, Chinese), executes with Windows XP Professional or Windows Server 2003, single license for 1 installation

Type of delivery: License key disk, emergency key disk, certificate of license, terms and conditions

- For expansion from 1500 to 5000 variables
- For expansion from 5000 to 10000 variables
- For expansion from 10000 to 30000 variables
- For expansion from 30000 to 80000 variables
- For expansion from 80000 to 120000 variables

6ES7 658-2EB07-2YD0

6ES7 658-2EC07-2YD0

6ES7 658-2ED07-2YD0

6ES7 658-2EE07-2YD0

6ES7 658-2EF07-2YD0

Additional components for redundant CAS

WinCC/Redundancy

For alignment of archives following restart; single license for 2 installations
Installation required on each of the redundant SIMATIC PCS 7 Industrial Workstations

6AV6 371-1CF06-2AX0

RS 232 connecting cable, 10 m

6ES7 902-1AC00-0AA0

Operator system

Operation and monitoring via Web

SIMATIC PCS 7 Web server

Overview

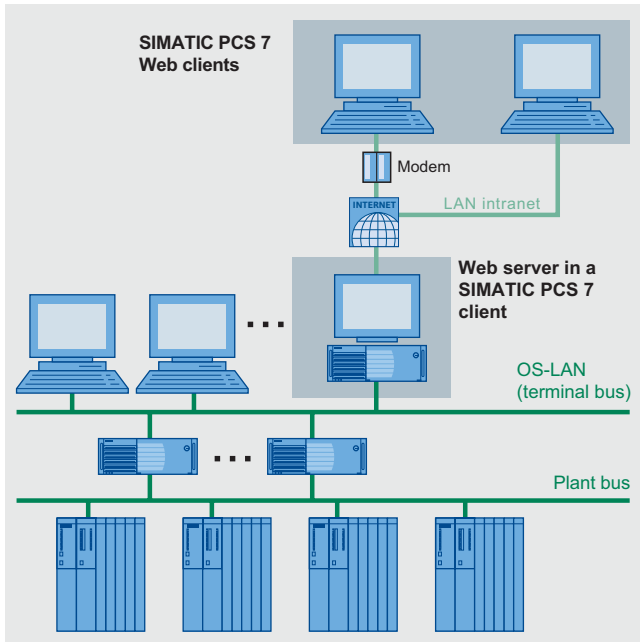

The SIMATIC PCS 7 Web server can be used to operate and monitor a system via intranet/Internet. The SIMATIC PCS 7 Web server uses the mechanisms of a multi-client for accessing the subordinate OS servers, and makes the project data globally available via intranet/Internet. The project-specific process data in the SIMATIC PCS 7 Web server are accessed via Web clients which are equipped with Internet Explorer.

Application

A differentiation is basically made between the following types of application when operating and monitoring SIMATIC PCS 7 systems via the Web:

- **Standard:**
Up to 50 Web clients access the data of **one** SIMATIC PCS 7 Web server over intranet/Internet.
- **Diagnostics:**
One or only a few Web clients have access to **several** SIMATIC PCS 7 Web servers/single-user systems for remote operation, diagnostics or monitoring.

Design

The products offered in the context of SIMATIC PCS 7 for operation and monitoring via Web permit cost-optimized solutions for both types of task:

- Server-based licensing is recommended for the "Standard" type of application. In this case, each SIMATIC PCS 7 Web server requires a SIMATIC PCS 7 Web Server license which includes the simultaneous access of 3, 10, 25 or 50 Web clients. Licenses are not installed on the Web clients themselves.
- Diagnostics licenses are tailored for such types of application. The SIMATIC PCS 7 Web Diagnostics license available for the Web diagnostics client allows the latter access to the assigned SIMATIC PCS 7 Web diagnostics servers/single-user systems at all times. On the server side, a SIMATIC PCS 7 Web Diagnostics Server license or SIMATIC PCS 7 Web Server license is required per SIMATIC PCS 7 Web server/single-user system. Since there are no functional differences between the license-free Web client and the Web client with SIMATIC PCS 7 Web Diagnostics license, mixed operation is possible.

The SIMATIC PCS 7 OS server with the Microsoft Windows Server 2003 operating system offered in Chapter "SIMATIC PCS 7 Industrial Workstation" in the Section "System-neutral components" can be used as the basic hardware for the SIMATIC PCS 7 Web server. The OS Software server of the SIMATIC PCS 7 V7.0 process control system is preinstalled on this basic device in addition to the operating system. In order to configure the SIMATIC PCS 7 Web server, you require the license "OS Software Client" in addition to the SIMATIC PCS 7 Web Server license or SIMATIC PCS 7 Web Diagnostics Server license. Deviating from the specification in the ordering data, the license of the OS Software Client in this special application is enabled for the Microsoft Windows Server 2003 operating system.

Function

The Web clients equipped with Internet Explorer and with plug-ins installable via the World Wide Web access the project data provided by the SIMATIC PCS 7 Web server via intranet/Internet. The process displays are converted by "Publishing" into a form suitable for presentation by the Internet Explorer.

A plant can be operated and monitored via the Web clients in the same manner as via the OS clients. The user must log on with the Web client just as with an OS client, and the rules for assignment of privileges are also identical. The input operations made on the Web clients are recorded in the OS operating log.

The integral OS user management guarantees high security when accessing the OS servers from the SIMATIC PCS 7 Web server. In line with the security requirements of the respective system, access protection is possible using password, firewall technology and individual security strategies.

Operator system

Operation and monitoring via Web

SIMATIC PCS 7 Web server

Selection and Ordering Data

Order No.

SIMATIC PCS 7 Web Server V7.0

6 languages (German, English, French, Italian, Spanish, Chinese), executes with Windows Server 2003, single license for 1 installation

Type of delivery:
License key disk, emergency key disk, certificate of license, terms and conditions

- For 3 clients
- For 10 clients
- For 25 clients
- For 50 clients

6ES7 658-2GA07-2YB0**6ES7 658-2GB07-2YB0****6ES7 658-2GC07-2YB0****6ES7 658-2GD07-2YB0**

SIMATIC PCS 7 PowerPack Web Server V7.0

6 languages (German, English, French, Italian, Spanish, Chinese), executes with Windows Server 2003, single license for 1 installation

Type of delivery:
License key disk, emergency key disk, certificate of license, terms and conditions

For expansion of PCS 7 Web server license

- From 3 to up to 10 clients
- From 10 to up to 25 clients
- From 25 to up to 50 clients

6ES7 658-2GB07-2YD0**6ES7 658-2GC07-2YD0****6ES7 658-2GD07-2YD0**

Selection and Ordering Data

Order No.

OS Software Client

SIMATIC PCS 7 OS Software Client V7.0¹⁾

6 languages (German, English, French, Italian, Spanish, Chinese), executes with Windows XP Professional, floating license for 1 user

Electronic documentation on PCS 7 toolset DVD

Type of delivery:

- License key disk, emergency key disk, certificate of license, terms and conditions
- PCS 7 V7.0 toolset DVDs, Microsoft SQL Server 2005 including EULA and supplementary CDs/DVDs (e.g. Microsoft ServicePacks and tools)

6ES7 658-2CX07-0YA5

SIMATIC PCS 7 Web Diagnostics Client V7.0

6 languages (German, English, French, Italian, Spanish, Chinese), executes with Windows XP Professional, single license for 1 installation

Type of delivery:
License key disk, emergency key disk, certificate of license, terms and conditions

6ES7 658-2JX07-2YB0

SIMATIC PCS 7 Web Diagnostics Server V7.0

6 languages (German, English, French, Italian, Spanish, Chinese), executes with Windows Server 2003, single license for 1 installation

Type of delivery: License key disk, emergency key disk, certificate of license, terms and conditions

6ES7 658-2HX07-2YB0

¹⁾ Deviating from the specification in the ordering data, the license of the OS Software Client V7.0 in this special application is also enabled for the Microsoft Windows Server 2003 operating system.

Overview

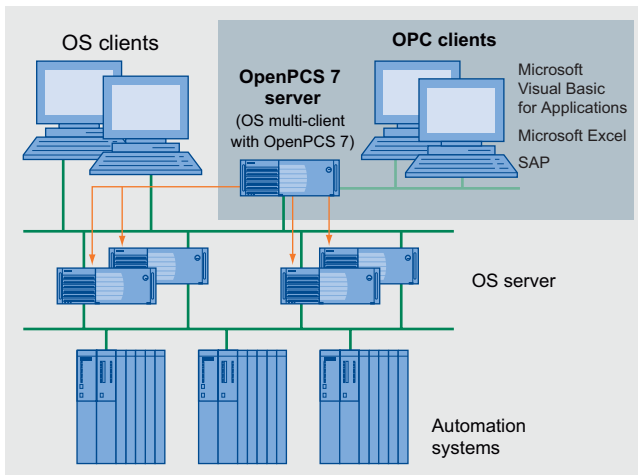

Systems for production planning, process data evaluation and management (OPC clients) that are at a higher level than the process control system can access SIMATIC PCS 7 V7.0 process data by means of the OpenPCS 7 server. The OpenPCS 7 server collects data for the OPC clients. Depending on the system configuration, these data may be distributed across different SIMATIC PCS 7 stations (OS server, central archive server). The OpenPCS 7 server covers the distribution of data with regard to the period (OS1 / OS2 / ... / CAS), the location (OS1 / OS2 / ...) and the redundancy (OS1 master / OS1 standby ...).

OpenPCS 7 replaces the @PCS 7 previously available in the SIMATIC PCS 7 context, and is simultaneously the pendant to the Connectivity Pack of the WinCC SCADA system. Access to the data of SIMATIC BATCH is therefore impossible.

Design

The OpenPCS 7 server can be operated in two different configurations:

- As autonomous OpenPCS 7 server based on a SIMATIC PCS 7 Industrial Workstation in the client version (recommended preferred configuration), or
- as multi-functional SIMATIC PCS 7 Industrial Workstation, client version, with OpenPCS 7 server and OS client functionalities (OpenPCS 7 server/OS client).

Each OPC client without PCS 7 OS/WinCC license requires a WinCC/Client Access license for access to the OpenPCS 7 server. The client access license referred to an OpenPCS 7 server is available in two versions:

- As access privilege for an OPC client and
- as access privilege for any number of OPC clients.

Function

The OpenPCS 7 interface is based on the OPC specifications (Openness, Productivity, Collaboration) that mainly make use of Microsoft's DCOM technology (Distributed Component Object Model) for communication between the applications. It supports the following standardized access options:

OPC DA (data access server)

For read and write access to process values according to OPC specification OPC DA V1.00, V2.05a, V3.00

As an OPC DA server, the OpenPCS 7 server provides other applications with current data from the OS data management. The OPC client can log itself on to ongoing changes or also write values.

OPC HDA (historical data access server)

For read-only access to archived process values according to OPC Specification OPC HDA V1.20

As an OPC HDA server, the OpenPCS 7 server provides other applications with historical data from the OS archive system. The OPC client, e.g. a reporting tool, can specifically request the required data by defining the start and end of a time interval. Numerous functions, e.g. variance, mean value or integral, already permit preprocessing by the HDA server and thus contribute towards reduction of the communications load.

OPC A&E (alarm & events server)

For read-only access to messages, alarms and events according to OPC Specification OPC A&E V1.10

As an OPC A&E server, the OpenPCS 7 server passes on OS messages together with all accompanying process values to the subscribers at the production and corporate management levels. They can of course also be acknowledged there. Filter mechanisms and subscriptions ensure that only selected, modified data are transmitted.

OPC "H" A&E (historical alarm & events server)

For read-only access to archived alarms and messages

By means of a Siemens extension to the OPC standard interface, the OpenPCS 7 server is also able to transmit historical alarms and messages from the archive to the subscribers at the production and corporate management levels.

OLE-DB

Simple, standardized direct access to the archive data in the Microsoft SQL server database of the operator system is possible with the OLE-DB. Through this, all OS archive data are accessible with the accompanying process values, message texts and user texts.

Operator system

Data exchange with host systems

OpenPCS 7

Selection and Ordering Data Order No.

Multi-functional OpenPCS 7 server/OS client

SIMATIC PCS 7 OpenPCS 7/OS Client V7.0

6ES7 658-0GX07-2YB0

Software for expansion of an existing OS client by OpenPCS 7 server functionality

6 languages (German, English, French, Italian, Spanish, Chinese), executes with Windows XP Professional, single license for 1 installation

Type of delivery:
License key disk, emergency key disk, certificate of license, terms and conditions

Autonomous OpenPCS 7 server

SIMATIC PCS 7 OpenPCS 7 V7.0

6ES7 658-0HX07-2YB0

OpenPCS 7 software for a separate OpenPCS 7 server, based on the hardware of the SIMATIC PCS Workstation, client version

6 languages (German, English, French, Italian, Spanish, Chinese), executes with Windows XP Professional, single license for 1 installation

Type of delivery:
License key disk, emergency key disk, certificate of license, terms and conditions

Selection and Ordering Data Order No.

OPC client access licenses to an OpenPCS 7 server

Access privilege for an OPC client WinCC/Client Access License (CAL)

6AV6 371-1ES06-0AX0

Single license for 1 installation

Access privilege for any number of OPC clients WinCC/Client Access License (CAL) per processor

6AV6 371-1ES06-0CX0

License for any number of clients per processor

Batch automation



6/2	SIMATIC BATCH
6/2	Introduction
6/3	SIMATIC BATCH hardware
6/5	SIMATIC BATCH software
6/5	Introduction
6/7	Server Basic Package
6/8	Batch Control Center
6/9	Recipe System
6/10	Batch Planning
6/11	Hierarchical Recipe
6/12	ROP Library
6/12	Separation Procedures/Formulas
6/12	SIMATIC BATCH API

Batch automation

SIMATIC BATCH

Introduction

Design



SIMATIC BATCH is configured as a single-user system or as a client/server system, and can be used in plants of any size due to its modular architecture and scalability in 5 steps using 10, 20, 40, 100 and unlimited units (instances of plant units).

With small applications, e.g. for laboratory automation, SIMATIC BATCH can also be combined with the PC-based starter system SIMATIC PCS 7 BOX 416. The capacity of SIMATIC BATCH is limited to 10 units in this case.

However, characteristic for the automation of batch processes using SIMATIC BATCH are client/server architectures with which one batch server and several batch clients process a plant project together. The batch server can also be configured with redundancy in order to increase availability.

Integration

Integration in SIMATIC PCS 7

SIMATIC BATCH is fully integrated in SIMATIC PCS 7. The plant data can be configured entirely using the engineering system. The engineering system transfers all data required for creating recipes to the batch server. It is therefore possible to edit recipes separate from the engineering system. Changes to the configuration which are made on the engineering system are available to the batch server using an update function (online/offline).

The SIMATIC Logon integrated in SIMATIC PCS 7 implements the following functions:

- Central user administration with access control
- Function "Electronic Signature"
This means that operations cannot be performed until enabled by authorized Windows users/user groups.

Communication with the automation systems

SIMATIC BATCH communicates with the automation system through the operator system. The PCS 7 operator stations relevant to the batch are made known to the batch server during configuration of the batch applications. Operator instructions and dialogs can also be integrated into the batch-AS communication. Attention is then drawn to necessary operator inputs, or data input is made possible, e.g. for laboratory values. SIMATIC BATCH provides special standard faceplates for controlling and monitoring plant units and equipment modules.

SFC instances derived from a SFC-type template are generally used as the interface to the subordinate automation level. The properties of the SFC type can be defined in a features dialog:

- Operations
- Setpoints/actual values
- Instance parameters
- Times etc.

It is also possible to use special batch interface blocks for communication with the processing programs in the automation systems, e.g. for plant expansions or for connection of non-SIMATIC systems.

Design

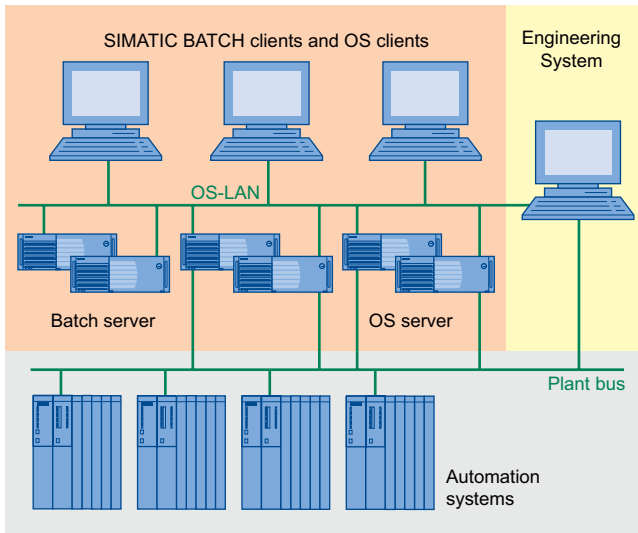

The modularity and flexibility of SIMATIC BATCH are optimally supported by the hardware available. The basic hardware from the Section "SIMATIC PCS 7 Industrial Workstation" in the Chapter "System-neutral components" can be used for SIMATIC BATCH. Please note that the operating system and the ES/OS software of the SIMATIC PCS 7 process control system are pre-installed as standard on the single station, server or client as the basic device. If these basic devices are used for SIMATIC BATCH, it is possible to extend or reject the existing SIMATIC PCS 7 installation, and restore it for the operating system using the restore DVD.

Hardware for small plants

For small plants, SIMATIC BATCH can be installed together with the OS software on a single station system. You can find further details on the hardware for this OS/BATCH single station with the ordering data of this section:

- In the Section "SIMATIC PCS 7 Industrial Workstation" of the Chapter "System-neutral components"
- In the Section "OS hardware" in the Chapter "Operator system"

A further alternative for small plants is operation of SIMATIC BATCH on the starter system SIMATIC PCS 7 BOX 416.

Client/server configuration

Batch process automation typically has a distributed client/server configuration with one batch server and several batch clients, which together process a plant project. The batch server of such a configuration can also be configured with redundancy in order to increase availability.

SIMATIC BATCH clients and OS clients can run on separate or common basic hardware. The batch server software is usually executed on separate server hardware (Batch Server). Depending on the load on the operator system, the OS and batch server software can also be executed on common server hardware (OS/Batch Server).

Since the batch server is only a node on the OS-LAN, we recommend that only the server version of the SIMATIC PCS 7 Industrial Workstation with BCE communication is used. The 10/100/1000 Mbit/s Ethernet RJ45 port is already onboard and can be used for connecting to the OS LAN.

Redundancy

The batch server redundancy is supported by the SIMATIC BATCH basic package. The two batch servers of a redundant pair of servers have identical configurations. Contrary to the case of OS redundancy, they must always be connected via a separate Ethernet connection in order to optimize the internal communication. Since the batch server is not usually connected to the plant bus, the Ethernet network card of the SIMATIC PCS 7 Industrial Workstation which is provided as standard for the plant bus connection can be used for the redundant communication.

An optical or electrical connection can be used depending on the environmental conditions and the distance between the two batch servers, e.g. up to 100 m per crossover network cable (RJ45 connectors). For details, refer to Manual "SIMATIC PCS 7 V7.0 fault-tolerant process control systems"; for appropriate cable material and further accessories, refer to Catalog I K PI.

If the SIMATIC BATCH software and the SIMATIC PCS 7 OS software are installed together on a redundant pair of servers, the two servers must be connected together via an additional desktop adapter network card for the redundant communication. The serial RS 232 connection described in the Section "OS redundancy" is omitted.

For information and components for connection to a redundant terminal bus, see page 9/28.

Expansion options

The basic hardware is expandable according to the customer's particular requirements and whether the hardware is used as single station, server or client with the following options:

- Multi-VGA graphics card for connection of up to 4 monitors
- Process monitors (see Spage 2/17)

The multi-VGA graphics cards "2 Screens" and "4 Screens" are offered for multichannel operation of an OS/batch single station or a batch client with 2 up to 4 process monitors. Using a multi-VGA graphics card, the visualization of the plant/unit can be divided among up to 4 process monitors per operator station by using different views. These plant sections can all be operated using just one keyboard and one mouse. The multi-VGA graphics cards are compliant with the EN 55022 and EN 50082 standards. Each card occupies one PCI slot.

Note:

Since all messages from SIMATIC BATCH are processed in the operator system's message system, the use of a signal module is only recommendable with multi-function OS/batch stations (clients, single stations).

Batch automation

SIMATIC BATCH

SIMATIC BATCH hardware

Selection and Ordering Data Order No.

Batch single station

SIMATIC PCS 7 Industrial Workstation, single station version

Windows XP Professional MUI operating system (German, English, French, Italian, Spanish, Chinese)

- | | | |
|--|----------------------------|----|
| • SIMATIC PCS 7 ES/OS 547B BCE WXP
Connection to plant bus with Ethernet network card RJ45 (PCI) 10/100/1000 Mbit/s and Basic Communication Ethernet (BCE) | 6ES7 650-0NF07-0YX0 | D) |
| • SIMATIC PCS 7 ES/OS 547B IE WXP
Connection to plant bus via Industrial Ethernet with CP 1613 A2 communications processor | 6ES7 650-0NF07-0YX1 | D) |

Batch server

SIMATIC PCS 7 Industrial Workstation, server version

Windows Server 2003 MUI operating system (German, English, French, Italian, Spanish, Chinese)

- | | | |
|--|----------------------------|----|
| • SIMATIC PCS 7 OS Server 547B BCE SRV03
Connection to plant bus with Ethernet network card RJ45 (PCI) 10/100/1000 Mbit/s and Basic Communication Ethernet (BCE) | 6ES7 650-0NH07-0YX0 | D) |
|--|----------------------------|----|

Batch client

SIMATIC PCS 7 Industrial Workstation, client version

Windows XP Professional MUI operating system (German, English, French, Italian, Spanish, Chinese)

- | | | |
|--|----------------------------|----|
| • SIMATIC PCS 7 OS Client 547B WXP | | |
| - without multi-VGA graphics card | 6ES7 650-0NG07-0YX0 | D) |
| - with Multi-VGA graphics card "2 Screens" | 6ES7 650-0NG07-0YA0 | D) |
| - with Multi-VGA graphics card "4 Screens" | 6ES7 650-0NG07-0YB0 | D) |

Selection and Ordering Data Order No.

Additional and expansion components

See also page 2/15

- | | | |
|--|--------------------|----|
| • Desktop adapter network card for redundant communication between two redundant OS/batch servers | A5E00504378 | B) |
|--|--------------------|----|

SIMATIC PCS 7 BOX 416

See page 3/8

B) Subject to export regulations: AL: N, ECCN: EAR99H
D) Subject to export regulations: AL: N, ECCN: 5D992B1

Note:

Ordering data in abbreviated form; for detailed Ordering data, see page 2/14.

Overview

The basic software for all SIMATIC BATCH system configurations (single stations or client/server systems) is the SIMATIC BATCH Server Basic Package, configured with

- Batch server software for 10 units (instances of plant units)
- 1 x SIMATIC BATCH BatchCC (Batch Control Center)
- 1 x SIMATIC BATCH Recipe System (recipe editor)

The basic software is always required. It provides everything needed to implement a small SIMATIC BATCH project on the hardware of a SIMATIC PCS 7 BOX 416, a single station or a client/server configuration consisting of a batch client and a batch server. It also includes the SIMATIC Logon for central user administration with access control and for the electronic signature.

Design

The capacity of the SIMATIC BATCH server basic packages can be expanded by SIMATIC BATCH PO options and PowerPacks. An appropriate number of SIMATIC BATCH BatchCC und SIMATIC BATCH Recipe System option packages is needed to expand the client/server configuration with additional batch clients. The functions of SIMATIC PCS 7 BOX 416, single stations, batch clients and batch servers can be expanded using the following optional packages (see table).

SIMATIC BATCH software components for SIMATIC PCS 7 BOX, single station, batch server and batch client

Software component		SIMATIC PCS 7 BOX 416	Single station	Batch server	Batch client 1	Batch Client 1+n
Basic software						
SIMATIC BATCH server basic package	Batch Server for 10 units	●	●	●		
	Batch Control Center	●	●		●	
	Recipe System	●	●		●	
Option packages						
SIMATIC BATCH ROP Library		opt	opt	opt		
SIMATIC BATCH Hierarchical Recipe		opt	opt	opt		
SIMATIC BATCH Separation Procedures/Formulas		opt	opt	opt		
SIMATIC BATCH API			opt	opt		
SIMATIC BATCH Batch Planning		opt	opt		opt	opt
SIMATIC BATCH Batch Control Center						opt
SIMATIC BATCH Recipe System						opt
SIMATIC BATCH PO options						
For expansion of the SIMATIC BATCH Server Basic Package to	20 units		opt	opt		
	40 units		opt	opt		
	100 units		opt	opt		
	Unlimited units		opt	opt		

●: Components included in delivery of basic software
opt: Can be ordered as options

SIMATIC BATCH works closely with the operator system and communicates through the operator system with the automation systems. For small plants, SIMATIC BATCH can therefore be installed together with the OS software on a single station or a SIMATIC PCS 7 BOX 416. The ordering data for the OS software can be found in the Chapter "Operator system".

Batch automation

SIMATIC BATCH software

Introduction

Function

SIMATIC BATCH offers a versatile range of powerful functions for automating batch processes, and these are described in detail in the system documentation. The most important functions of the various program components are presented in summarized form on the following pages. The current system version SIMATIC BATCH V7.0 particularly features the following new functions:

- By means of a user-friendly formula editor which is able to link process parameters or constants using the four fundamental arithmetic operations, you can enter formulas at the step points of a sequence (phase parameters, transitions).
- Deepening and further development of cooperation with SIMATIC Route Control:
 - The locations for material transport which are defined in the SIMATIC Manager and are specific to Route Control can be exported to SIMATIC BATCH.
 - The locations can be used as transfer parameters (source, target or via) for the transport phases so that products of a batch can be routed into other specific units.
- It is possible to compare text variables and fixed text strings for transitions.
- Product names can be saved in the formulas.
- System-based support for versioning of recipes, formulas and library objects facilitates plant validation.
- Through user-specific saving of individual system settings, e.g. GUI, window or language, the usual working environment is available on any client.
- In the recipe editor and in BatchCC (except in the message window), swapping to a new language is effective immediately, i.e. even before the current application is completed.

Batch automation SIMATIC BATCH software

Server Basic Package

Overview

The SIMATIC BATCH server basic package contains:

- Batch server software for 10 units (instances of plant units)
- SIMATIC BATCH BatchCC (Batch Control Center)
- SIMATIC BATCH Recipe System (recipe editor)

An integral component is also SIMATIC Logon for central user administration and access control as well as for the "Electronic signature", e.g. for enabling basic recipes, formulas and library objects.

A small SIMATIC BATCH project can be implemented on the hardware of a SIMATIC PCS 7 BOX 416, single station or client/server combination (batch client and batch server) with the SIMATIC BATCH Server Basic Package.

The capacity of the Server Basic Package can be extended by means of SIMATIC BATCH PO options and SIMATIC BATCH PowerPacks to batches with 20, 40, 100 or unlimited units.

Selection and Ordering Data

Order No.

SIMATIC BATCH Server Basic Package V7.0 (10 units)

For single station, client/server configuration or SIMATIC PCS 7 BOX 416, comprising:

- Batch server for 10 units ¹⁾
 - Recipe System
 - Batch Control Center (BatchCC)
- 6 languages (German, English, French, Italian, Spanish, Chinese), executes with Windows XP Professional or Windows Server 2003, single license for 1 installation

Type of delivery:
License key disk, certificate of license, terms and conditions

6ES7 657-0SA07-0YB0 C)

SIMATIC BATCH PO Option V7.0

For expansion of the SIMATIC BATCH Server Basic Package

6 languages (German, English, French, Italian, Spanish, Chinese), executes with Windows XP Professional or Windows Server 2003, single license for 1 installation

Type of delivery:
License key disk, certificate of license, terms and conditions

- To 20 units
- To 40 units
- To 100 units
- To unlimited units

6ES7 657-0XB07-2YB0

6ES7 657-0XC07-2YB0

6ES7 657-0XD07-2YB0

6ES7 657-0XE07-2YB0

SIMATIC BATCH PowerPack V7.0

For expansion of the units

6 languages (German, English, French, Italian, Spanish, Chinese), executes with Windows XP Professional or Windows Server 2003, single license for 1 installation

Type of delivery:
License key disk, certificate of license, terms and conditions

- From 20 units to 40 units
- From 40 units to 100 units
- From 100 units to unlimited units

6ES7 657-0XC07-2YD0

6ES7 657-0XD07-2YD0

6ES7 657-0XE07-2YD0

C) Subject to export regulations: AL: N, ECCN: EAR99S

¹⁾ Instances of plant units

Batch automation SIMATIC BATCH software

Batch Control Center

Overview

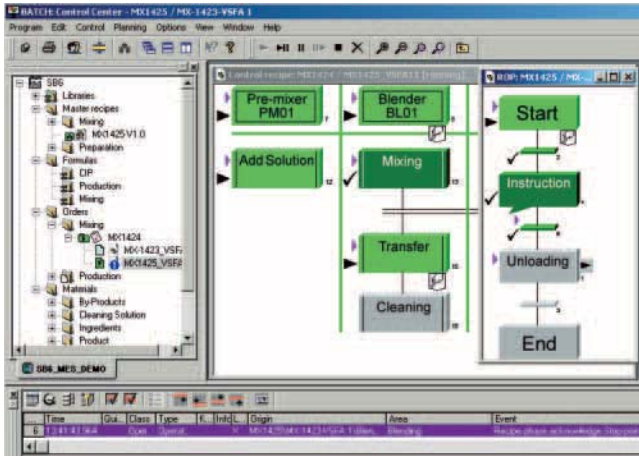

The SIMATIC BATCH Batch Control Center (BatchCC) is the "command center" for monitoring and controlling batch processes with SIMATIC BATCH. Using BatchCC you can manage all data relevant to SIMATIC BATCH through a graphical user interface.

Note:

The SIMATIC BATCH batch control center option package is included once in the SIMATIC BATCH server basic package.

Function

BatchCC offers powerful functions for the following tasks:

- Reading in and updating the plant data of the basic automation
- Definition of user privileges for all functions, for clients, or for plant units of SIMATIC BATCH
- Definition of material names and codes
- Management of master recipes, and starting the recipe editor in order to enter the recipe structure
- Management of libraries with recipe elements (library operations)
- Importing and exporting of basic recipes, formulas and library objects
- Editing of formula categories and management of associated formulas (parameter sets)
- Creation of batches with master recipes
- Starting of batch processing and controlling of batches
- Monitoring and diagnostics of batch processing
- Online modification of occupation strategy and assignment of units during batch processing
- Recording and archiving of recipes and batch data

Selection and Ordering Data

Order No.

SIMATIC BATCH BatchCC V7.0

6 languages (German, English, French, Italian, Spanish, Chinese), executes with Windows XP Professional or Windows Server 2003, floating license for 1 user

Type of delivery: License key disk, certificate of license, terms and conditions

6ES7 657-0LX07-2YB5

Overview

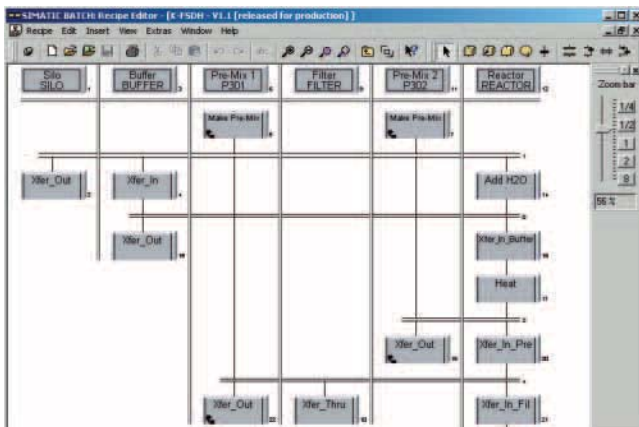

The SIMATIC BATCH recipe system option package presents itself to the user in the form of a recipe editor. The recipe editor is a convenient tool for simple, intuitive creation and modification of master recipes and library operations. It has a graphical user interface, editing functions typical of those in Microsoft Windows for single and group objects, and a structural syntax check function.

The basis for recipe creation are the batch objects created from the batch plant configuration using the SIMATIC PCS 7 engineering system, e.g. plant units and technological functions. The batch recipe editor can be started individually, but can also be called from BatchCC.

Note:

The SIMATIC BATCH recipe system option package is included once in the SIMATIC BATCH server basic package.

Function

- Creation of new master recipes and library operations
- Modification of existing master recipes and library operations (changes in structure or parameters)
- Documentation of master recipes and library operations
- Implementation of plausibility checks
- Selection of unit candidates using limitation of equipment properties
- Assignment of enabling for test or production of master recipes and library operations
- Routing of products of one batch into specific other units

Selection and Ordering Data

Order No.

SIMATIC BATCH Recipe System V7.0

6 languages (German, English, French, Italian, Spanish, Chinese), executes with Windows XP Professional or Windows Server 2003, floating license for 1 user

Type of delivery: License key disk, certificate of license, terms and conditions

6ES7 657-0AX07-2YB5

Batch automation

SIMATIC BATCH software

Batch Planning

Overview

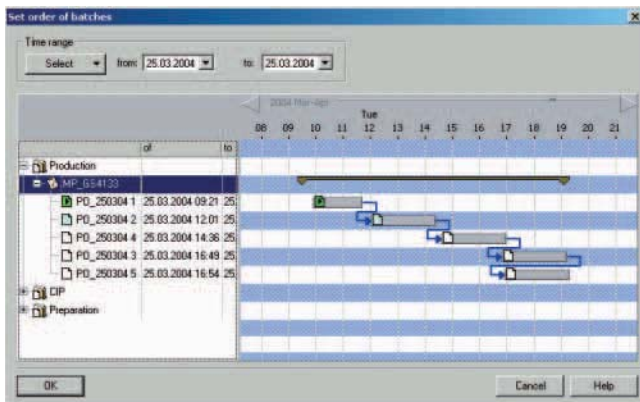

The SIMATIC BATCH BatchCC enables the creation of individual production orders and batches. Far more planning functionality is offered by the additional SIMATIC BATCH batch planning option package. BatchCC can then be used to plan batches in advance for a large number of production orders.

Function

The range of functions includes not only the planning but also the modification, canceling, deleting and releasing of batches. Dividing and saving batches for a production can be performed manually or, after specifying the number of batches and the production quantity, automatically. The following batch parameters can be selected and changed before the release order is given:

- Quantity to be prepared
- Starting mode (immediately, by operator input or time-controlled)
- Plant unit assignment
- Formula (parameter set)
- Run sequence (interlinking with the previous or next batch)
- Indication of batch runtime

Batch planning and control are conveniently supported and simplified by special displays such as order category list, production order list, batch planning list, batch status list and batch results list.

All batches and their plant unit assignments can be clearly presented by a combination of Gantt diagram and table. Conflicts of time or due to multiple assignment of plant units are marked by symbols. Time conflicts are easily eliminated by moving the affected batches in the Gantt diagram.

Selection and Ordering Data

Order No.

SIMATIC BATCH Batch Planning V7.0

6 languages (German, English, French, Italian, Spanish, Chinese), executes with Windows XP Professional or Windows Server 2003, floating license for 1 user

Type of delivery: License key disk, certificate of license, terms and conditions

6ES7 657-0BX07-2YB5

Overview

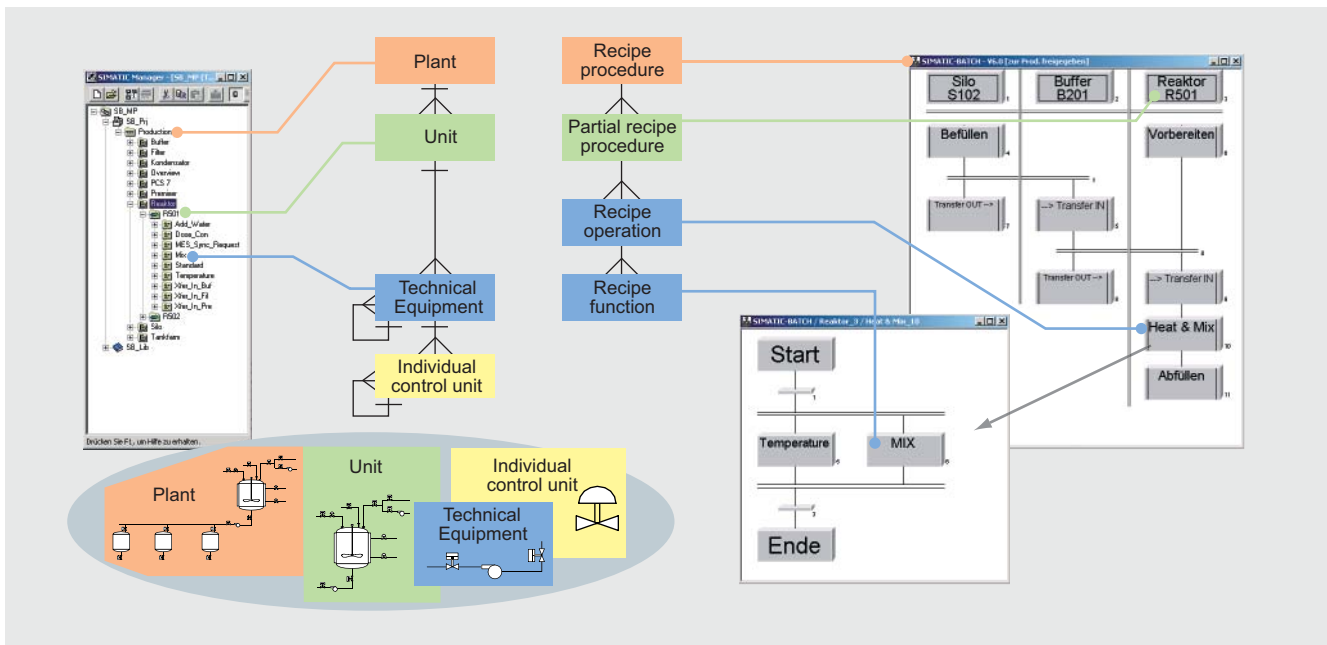

Hierarchical recipes according to ISA-88.01

SIMATIC BATCH and SIMATIC PCS 7 form a functional unit that fully covers the models described in the ISA-88.01 standard.

The hierarchical recipe structure is mapped on the plant module as follows:

- Recipe procedure for controlling the process or the production in a plant
- Partial recipe procedure for controlling a process step in a plant unit
- Recipe operation/function for the process engineering task/function in an equipment module

Selection and Ordering Data

Order No.

SIMATIC BATCH**Hierarchical Recipe V7.0**

6 languages (German, English, French, Italian, Spanish, Chinese), executes with Windows XP Professional or Windows Server 2003, single license for 1 installation

Type of delivery: License key disk, certificate of license, terms and conditions

6ES7 657-0FX07-2YB0

Batch automation

SIMATIC BATCH software

ROP Library

Overview

The management of recipe operations is conveniently supported by a user library (ROP library). Library recipe operations can be inserted as a reference in recipe procedures and can thus be modified from a central location. This reduces the requirements for engineering and validation. If the reference link is broken, the recipe operation becomes a fixed component of the recipe procedure, and is thus independent of further central modifications.

Selection and Ordering Data

Order No.

SIMATIC BATCH ROP Library V7.0

6 languages (German, English, French, Italian, Spanish, Chinese), executes with Windows XP Professional or Windows Server 2003, single license for 1 installation

Type of delivery: License key disk, certificate of license, terms and conditions

6ES7 657-0GX07-2YB0

Separation Procedures/Formulas

Overview

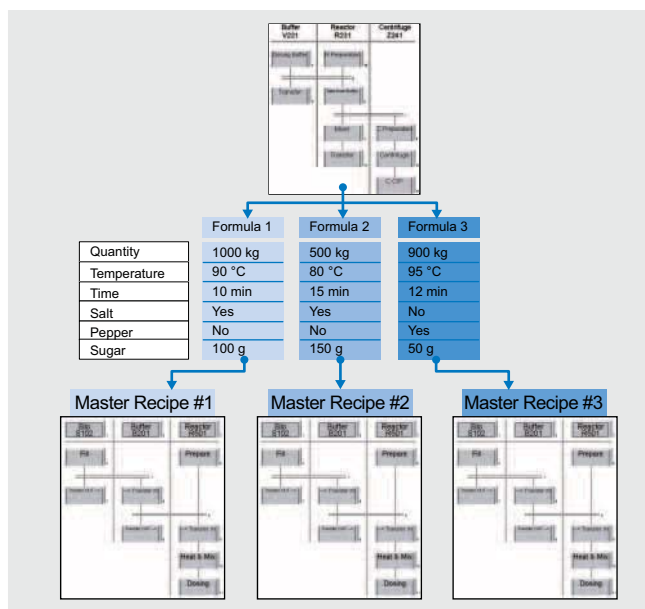

The flexibility achieved by recipes which are independent of plant units can be increased even further if the procedure and parameter sets (formulas) are separated from one another. Various master recipes can be created by linking several formulas using a recipe procedure. This enables central modification of procedures. The formula structure is determined by the formula category defined by the user.

Selection and Ordering Data

Order No.

SIMATIC BATCH Separation Procedures/ Formulas V7.0

6 languages (German, English, French, Italian, Spanish, Chinese), executes with Windows XP Professional or Windows Server 2003, single license for 1 installation

Type of delivery: License key disk, certificate of license, terms and conditions

6ES7 657-0HX07-2YB0

SIMATIC BATCH API

Overview

The SIMATIC BATCH API application programming interface is an open interface for custom expansions. It provides the user with access to SIMATIC BATCH data and functions and enables the programming of special industry or project specific applications.

Selection and Ordering Data

Order No.

SIMATIC BATCH API V7.0

1 language (English), executes with Windows XP Professional or Windows Server 2003, single license for 1 installation

Type of delivery: License key disk, certificate of license, terms and conditions

6ES7 657-0MX07-2YB0

SIMATIC Route Control



7/2	Introduction
7/4	Route Control hardware
7/6	Route Control runtime software
7/8	Route Control engineering software



SIMATIC Route Control

Introduction

Overview



SIMATIC Route Control adds a tool for the configuration, control, monitoring and diagnostics of material transports in pipeline networks. It is not specialized on any particular industry.

With SIMATIC Route Control, which can also be combined with SIMATIC BATCH, users of SIMATIC PCS 7 are capable of automating not only their production processes and associated warehouses but also the material transports linking both areas.

SIMATIC Route Control can handle complex networks as well as simple transport routes. In particular SIMATIC Route Control is predestined for plants with a multitude of complex route combinations or extensive tank farms such as are found above all in the chemical, petrochemical and food and drinks industries.

Application

The possible applications of SIMATIC Route Control extend from small plants with simple/static lines up to plants in the medium and upper performance range with an extensive network of routes/pipes.

SIMATIC Route Control is particularly recommended for the following conditions:

- Frequent conversions and extensions of the transport network including actuators and sensors
- Transport routes with high flexibility, characterized by:
 - Regularly changing materials
 - Dynamic selection of the origin and destination of the material transport (including reversal of direction on bidirectional transport routes)
- Numerous simultaneous material transports
- Plant projects in combination with SIMATIC BATCH

Configuration

SIMATIC Route Control is fully integrated in SIMATIC PCS 7 and, thanks to the modular architecture and 3-step scalability (up to 30 / up to 100 / up to 300 simultaneous material transports), can be flexibly adapted to different sizes of plant.

SIMATIC Route Control provides graded user privileges for engineering, operating and maintenance personnel who are integrated into the user administration with SIMATIC Logon. SIMATIC Logon is an integral component of SIMATIC PCS 7.

Route Control in the engineering system

The Route Control Engineering Tool, the Route Control Library and the Route Control Assistant are integrated together with the other engineering tools of the SIMATIC PCS 7 process control system in the central engineering system.

In SIMATIC PCS 7, blocks from the SIMATIC PCS 7 standard library are inserted into CFC plans and connected to plant control blocks in accordance with the technological requirements in order to control and monitor the elements of a plant. These individual connections are omitted with SIMATIC Route Control (RC). You adapt the standard blocks of the technological elements relevant to RC (RC elements) using standardized interface blocks from the Route Control library, and allow RC to control and monitor the elements during operation. This is of course also possible with existing plants without an increased overhead.

The blocks of the Route Control library support redundancy at the controller level. They can be used with standard automation systems or also with fault-tolerant systems or mixed configurations. The changes in the engineering system can be recorded (Change log), both in the SIMATIC PCS 7 project and in the RC project.

The Route Control Assistant functions as the interface between the PCS 7 basic configuration expanded by RC components and the RC engineering tool. It analyzes the hardware and software configuration of the SIMATIC PCS 7 (multi-)project, and generates a database which serves as the basis for further, RC-specific configuration with the RC engineering tool.

During the RC-specific configuration, the elements imported from the SIMATIC PCS 7 project by the Route Control Assistant must be inserted into a sub-route structure. These sub-routes divide the plant. The complete routes will be subsequently "joined together" from them during the automatic route searching. The response of the sub-routes in a particular function are already defined when inserting the elements into them. Functions represent the technological requirements when operating the plant (e.g. "Open source", "Pumps" etc.).

As a rule: the more finely divided the sub-route structure, the more flexible the subsequent automatic route searching. With purely static routes, a sub-route can already be a complete route.

Route Control Server/Route Control Center

After the transport network has been configured and the variants of the material transports tested, the Route Control configuration data are transferred to the Route Control Server where they can be activated via the Route Control Center at a suitable time from the process engineering viewpoint. From then onwards, the new data are taken into consideration when searching for the route.

If a material transport is pending during operation, a route (material transport) is requested by the controller (e.g. using an adapted RC SFC type) or by the operator on the Route Control Center. In addition to definition of the source and target as well as up to 10 optional locations (intermediate points), this also includes the creation of a start signal on the route control block RC_IF_ROUTE in the automation system (AS). The AS "informs" the RC Server which then starts searching for the route and – if possible – combines the statically defined sub-routes into a complete transport route. From this point onward, the Route Control takes over control and monitoring of all RC elements involved in the transport route. If faults occur, detailed diagnostics information is provided concerning the cause, e.g. why the search for a suitable transport route was unsuccessful. The plant control program only switches the individual technological functions, everything else is handled by the Route Control.

The Route Control Server (RC Server) supplies the Route Control Clients (Route Control Center) with the necessary data and transfers their operations to the automation systems.

For maintenance purposes, an automation system can be specifically set to "in maintenance" (out of service). The material transports being carried out by this automation system are still continued until finished. However, new material transports are no longer permitted.

RC block symbols and faceplates

In the process displays of the SIMATIC PCS 7 operator systems, each route block is represented by an RC block symbol and an RC faceplate. Through a route block's RC block symbol it is possible to select its RC faceplate, and through a route block's RC faceplate it is possible to select the Route Control Center.

Drop-down lists for location selection

The selection of locations (synonym: nodes) is made simpler in the process display by means of drop-down lists.

SIMATIC Route Control

Route Control Hardware

Design

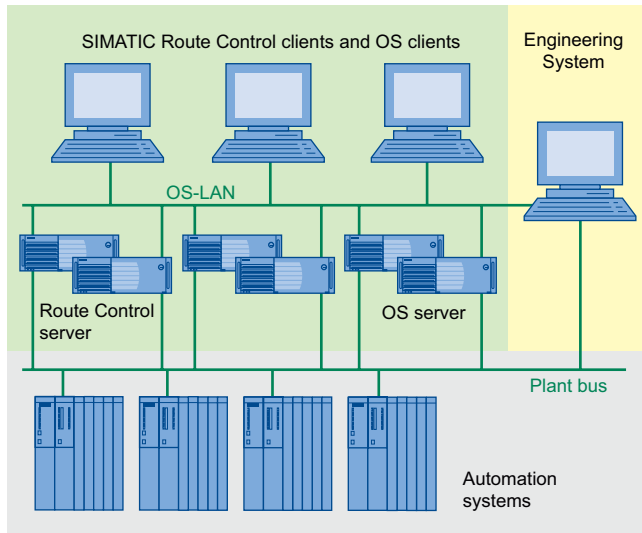

The modularity and flexibility of SIMATIC Route Control are optimally supported by the hardware available. The basic hardware from page 2/14 can be used for SIMATIC Route Control.

Hardware for small plants

For small plants, SIMATIC Route Control can be installed either alone or together with the OS software on a single station system or a SIMATIC PCS 7 BOX 416. You can select the hardware for the OS/RC single station at page 2/14, page 5/6, or further down in this section. You can find information and the ordering data for the SIMATIC PCS 7 BOX 416 at page 3/8.

Client/server configuration

Distributed multi-user systems with client/server architecture, expandable with up to 32 clients per server, are typical for the automation of material transports with SIMATIC Route Control. Basically it is possible to operate an RC Server, Batch Server and OS Server on shared basic hardware. However, availability will be higher and performance better if each component has its own server hardware. The availability of the RC Server can be further increased through redundant configuration of the server hardware. SIMATIC PCS 7 supports multiple-station systems with up to 12 servers/server pairs.

The Route Control Client is represented by the Route Control Center (RCC). The RCC can be installed on an OS Client, a Batch Client or separate client hardware.

RC server and OS/RC single stations can be connected to the Industrial Ethernet plant bus via a CP 1613 A2 communications processor or via a simple FastEthernet network card with BCE (suitable for communication with up to 8 automation systems; not H systems).

The CP 1613 communication integrated in the IE version of the SIMATIC PCS 7 Workstation for single stations and servers is a combination of CP 1613 communications processor and S7-1613 communications software. When using fault-tolerant automation systems, the SIMATIC PCS 7 Workstation requires the S7-REDCONNECT software instead of the S7-1613 communications software. The S7-REDCONNECT Upgrade is suitable for upgrading the communications software (for ordering data, see page 9/28).

Redundancy

RC Server redundancy is supported by the SIMATIC Route Control Server software. Further software components or a separate connection between the two servers as is the case with the OS server redundancy or batch server redundancy are not required.

With the assistance of the SIMATIC Route Control Server software, the two redundant RC servers carry out mutual monitoring during operation. If the active RC server fails, the redundant partner immediately becomes the master and takes over operation. The RC clients are automatically switched over to the new master in this case. Following return of the failed RC server, data matching is carried out with the active RC server, and the latter remains the master.

For information and components for the redundant bus connection (plant bus and terminal bus), see page 9/28.

Expansion options

The basic hardware (PC basic unit) is expandable with the following options according to the customer's particular requirements and whether the hardware is used as RC Single Station, RC Server or Batch Client:

- Multi-VGA graphics card for connection of up to 4 monitors
- Process monitors (see page 2/17)

The Multi-VGA graphics cards "2 Screens" and "4 Screens" are offered for multichannel operation of an OS/RC Single Station or a client with 2 up to 4 process monitors. Views distributed over 2 or as many as 4 process monitors by means of a graphics card can be controlled using one keyboard and one mouse. The Multi-VGA graphics cards are compliant with EN 55022 and EN 50082 standards. Each card occupies one PCI slot in the operator station.

Note:

Since all messages from SIMATIC Route Control are processed in the operator system's message system, it is not necessary to use a signal module.

Requirements for selection of the automation systems

SIMATIC Route Control can operate together with the WinAC Slot 416 controller of the SIMATIC PCS 7 BOX 416 (up to 30 simultaneous material transports) and with the following automation systems of the SIMATIC PCS 7 process control system:

- AS 416-3 (up to 30 simultaneous material transports)
- AS 417-4
- AS 417H

Safety-related automation systems, e.g. AS 417F/FH, cannot be used to control material transport with SIMATIC Route Control.

Selection and Ordering Data	Order No.
RC single station	
SIMATIC PCS 7 Industrial Workstation, single station version Windows XP Professional MUI operating system (German, English, French, Italian, Spanish, Chinese)	
<ul style="list-style-type: none"> • SIMATIC PCS 7 ES/OS 547B BCE WXP Connection to plant bus with Ethernet network card RJ45 (PCI) 10/100/1000 Mbit/s and Basic Communication Ethernet (BCE) for up to 8 automation systems (not H-systems) 	6ES7 650-0NF07-0YX0 D)
<ul style="list-style-type: none"> • SIMATIC PCS 7 ES/OS 547B IE WXP Connection to plant bus with CP 1613 A2 communications processor 	6ES7 650-0NF07-0YX1 D)

RC server

SIMATIC PCS 7 Industrial Workstation, server version Windows Server 2003 MUI operating system (German, English, French, Italian, Spanish, Chinese)	
<ul style="list-style-type: none"> • SIMATIC PCS 7 OS Server 547B BCE SRV03 Connection to plant bus with Ethernet network card RJ45 (PCI) 10/100/1000 Mbit/s and Basic Communication Ethernet (BCE) for up to 8 automation systems (not H-systems) 	6ES7 650-0NH07-0YX0 D)
<ul style="list-style-type: none"> • SIMATIC PCS 7 OS Server 547B IE SRV03 Connection to plant bus with CP 1613 A2 communications processor 	6ES7 650-0NH07-0YX1 D)

RC client

SIMATIC PCS 7 Industrial Workstation, client version Windows XP Professional MUI operating system (German, English, French, Italian, Spanish, Chinese)	
<ul style="list-style-type: none"> • SIMATIC PCS 7 OS Client 547B WXP <ul style="list-style-type: none"> - without multi-VGA graphics card - with Multi-VGA graphics card "2 Screens" - with Multi-VGA graphics card "4 Screens" 	6ES7 650-0NG07-0YX0 D) 6ES7 650-0NG07-0YA0 D) 6ES7 650-0NG07-0YB0 D)

Selection and Ordering Data Order No.**Additional and expansion components****SIMATIC NET S7-REDCONNECT Upgrade**

for communication with fault-tolerant AS systems, see page 9/28

Further additional and expansion components can be found at page 2/15

D) Subject to export regulations: AL: N, ECCN: 5D992B1

Note:

Ordering data in abbreviated form; for detailed Ordering data, see page 2/14.

For Ordering data of the SIMATIC PCS 7 BOX 416, refer to page 3/8.

SIMATIC Route Control

Route Control runtime software

Overview

The Route Control Software is structured such that SIMATIC Route Control can be flexibly adapted to different plant sizes and architectures (single/multi-user systems):

- Route Control Engineering (component of the SIMATIC PCS 7 Engineering System)
- Route Control Server
- Route Control Center (RCC)

Software components (runtime)	SIMATIC PCS 7 BOX 416	Single station	Server single	Server redundant	Client
SIMATIC Route Control Server Up to 30 simultaneous material transports	1	1	1	2	--
SIMATIC Route Control Server PowerPack	--	1	1	2	--
• From 30 up to 100 simultaneous material transports	--	1	1	2	--
• From 100 up to 300 simultaneous material transports	--	1	1	2	--
SIMATIC Route Control Center	1	1	--	--	1

SIMATIC Route Control works closely with the operator system, hence where small plants are concerned it is possible for the Route Control Center and Route Control Server to be installed not only on their own but also together with the OS software on a single station or a SIMATIC PCS 7 BOX 416 (up to 30 simultaneous material transports). The ordering data for the OS software can be found in the Chapter "Operator system".

In the case of multi-user systems with small quantity frameworks it is also possible to operate the Route Control Server, Batch Server and OS Server on shared basic hardware. However, availability will be higher and performance better if they are installed on separate server hardware.

The Route Control Server program package suitable for up to 30 simultaneous material transports can be expanded by means of add-on PowerPacks to meet higher requirements (up to 100 or 300 simultaneous material transports).

The Route Control Client is represented by the Route Control Center (RCC). The RCC can be installed on an OS Client, a Batch Client or separate client hardware.

Function

Route Control Server

The Route Control Server supplies the RC Clients (Route Control Center) with the necessary data and transfers their operations to the automation systems. When a material transport is requested through the Route Control Center, it is the job of the RC Server to dynamically compile a suitable transport route from the partial routes which were configured using a map of the automation systems on the basis of the selected parameters (source, destination and intermediate locations) and with due consideration of other parameters (e.g. function catalogs, function IDs or material IDs). Configuration changes can be taken immediately into account in the determination of a suitable transport route after transfer from the Route Control Engineering Tool to the Route Control Server and subsequent activation through the Route Control Center (online loading).

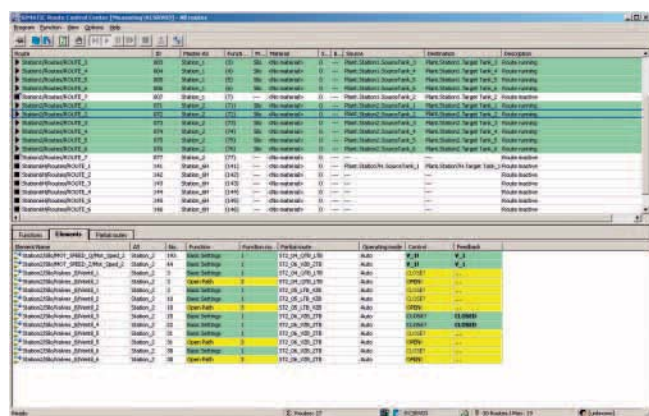

Route Control Center

Route Control Center (RCC)

The RCC can be called either from the faceplate of a route block or from the keyset on the operator station. It displays all of a material transport's relevant route data and error information in several coordinated views

Route Control runtime software

Key functional features are:

- Overview of all RC elements, partial routes and request details
- Operation of the selected material transport: Selection of operating mode: manual/automatic; request, start, stop, continue and end material transport in manual mode; set/change request parameters (locations: source, destination, intermediate locations) and general properties (function catalog, function ID, material ID and "ignore error") in manual mode; activate/deactivate sequence functions in manual mode
- Diagnostics of material transport request errors caused by locked RC elements, locked partial routes, inconsistent actuations or prohibited sequential material
- Diagnostics of currently running material transports: color and text display of transport route status in the route view of the RCC; detailed analyses by evaluation of feedback signals from RC elements
- Server functions: select RC Server, display RC Server status, update view (read in data again from the RC Server)
- Display of the operator who has logged on
- Definition of route parameters (source, destination, material, function ID etc.), and saving and loading these settings with names
- Switchover between "AS in maintenance" and "AS in operation"

Selection and Ordering Data

Order No.

SIMATIC Route Control Server V7.0**for up to 30 simultaneous material transports**

For SIMATIC PCS 7 BOX 416, single station and client/server configuration

6 languages (German, English, French, Italian, Spanish, Chinese), executes with Windows XP Professional or Windows Server 2003, single license for 1 installation

Type of delivery: License key disk, emergency key disk, certificate of license, terms and conditions

6ES7 658-7FA07-0YB0**SIMATIC Route Control Server PowerPack V7.0**

For expansion of SIMATIC Route Control Server

6 languages (German, English, French, Italian, Spanish, Chinese), executes with Windows XP Professional or Windows Server 2003, single license for 1 installation

Type of delivery: License key disk, emergency key disk, certificate of license, terms and conditions

- From 30 to up to 100 simultaneous material transports

6ES7 658-7FB07-0YD0

- From 100 to up to 300 simultaneous material transports

6ES7 658-7FC07-0YD0**SIMATIC Route Control Center V7.0**

6 languages (German, English, French, Italian, Spanish, Chinese), executes with Windows XP Professional or Windows Server 2003, floating license for 1 user

Type of delivery: License key disk, emergency key disk, certificate of license, terms and conditions

6ES7 658-7EX07-0YB5

SIMATIC Route Control

Route Control engineering software

Overview

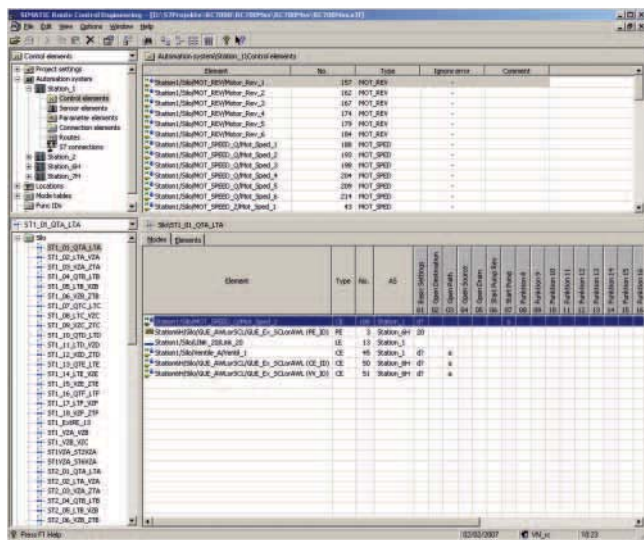

The Route Control (RC) configuration supplements the basic SIMATIC PCS 7 plant configuration with blocks from the PCS 7 standard library. Existing plants are then also easy to upgrade with SIMATIC Route Control. Technological elements of relevance for control of the material transport (RC elements) are adapted in the CFC Editor using uniform interface blocks from the Route Control Library. The RC elements include:

- Control elements (actuators)
- Sensor elements (sensors)
- Parameter elements (setpoints)
- Connection elements (material information related to partial route)

Function

Locations of partial or complete routes are configured in the SIMATIC Manager as "Equipment properties of plant units" and transferred to the RC project together with the other RC-relevant basic data of the SIMATIC PCS 7 project. The configuration requirements caused by many repeated sequences can be minimized by exporting locations in CSV format, duplicating and modifying them using a spreadsheet program, and then importing them again.

Locations (synonym: nodes) are parameters for requesting a material transport (source, destination, intermediate locations/via) and which mark the start and end of each partial route, and thus also the source and destination of a material transport.

In addition to the basic tools (SIMATIC Manager, CFC, etc.) of the SIMATIC PCS 7 engineering system, the following configuration components of the SIMATIC Route Control Engineering program package are available for configuration of the route control applications:

Route Control library

The Route Control library contains blocks for RC and transport route configuration and interface blocks for RC elements. It is provided in the catalog of the CFC editor.

Route Control wizard

The Route Control wizard is the interface between the SIMATIC PCS 7 basic configuration supplemented with RC interface blocks and the actual RC configuration in the RC engineering tool. The wizard, which can be called up from the SIMATIC Manager menu, accepts the RC-specific configuration data of the SIMATIC PCS 7 project into the Route Control engineering. In doing so, it carries out plausibility checks, defines the AS-OS and AS-AS communication connections (NetPro and CFC), and configures the RC server signals.

Route Control Engineering tool

Following importing of the basic data of a SIMATIC PCS 7 project relevant to the RC into an RC project, the RC-specific objects are configured using the Route Control Engineering tool:

- Partial routes:
 - division of the transport paths into partial routes is used to increase the flexibility and minimize the configuring overhead by means of repeated application. Relevant partial route parameters: "bidirectional" and "priority" (lowest total of partial route priorities is decisive when searching for the overall route).
- Interconnections:
 - Through inclusion in a partial route, the RC elements receive additional properties depending on the type, and these can be edited using configuration dialogs (e.g. in the basic setting: "close valve").
- Function catalogs:
 - The partial routes can be assigned to function catalogs depending on technological and product-specific aspects, e.g. "cleaning" or "product transport". In the route search, function catalogs permit restriction of the resulting quantity to the type of material transport.
- Function steps/sequence functions:
 - Function catalogs contain as many as 32 configurable technological sequence functions which define the sequence of material transport by means of the RC elements connected in the partial routes, e.g. base position of the control elements, open transport valves, open origin valve, switch on pump).

Route Control engineering software

Configuration of the partial routes and assignment of the RC elements to the partial routes are performed in a matrix of the Route Control Engineering tool. With the aid of generic elements, objects or blocks generated on a user-specific basis can be integrated into the RC project and handled like RC elements.

Special configuration functions make it easier to perform repetitive routine work and extend the range of options for controlling material transport, e.g.:

- Exporting configuration data in the form of CSV files to Microsoft Excel, copying and editing the data there, and then re-importing the files into Route Control
- Controlling the joint use of partial routes by configurable function IDs
- Checking material compatibilities and interlocking partial routes in case of incompatible material sequences based on the material ID saved in the connection element of the partial route
- Injection of dynamic (external) setpoints coming from the process at runtime into the route block (e.g. weighed quantity)

Selection and Ordering Data

Order No.

SIMATIC Route Control Engineering V7.0

6 languages (German, English, French, Italian, Spanish, Chinese), executes with Windows XP Professional or Windows Server 2003

Type of delivery: License key disk, emergency key disk (not with rental license), certificate of license, terms and conditions

- Floating license for 1 user
- Rental license for 30 days

6ES7 658-7DX07-0YB5**6ES7 658-7DX07-0YB6**

SIMATIC Route Control



7

Asset Management

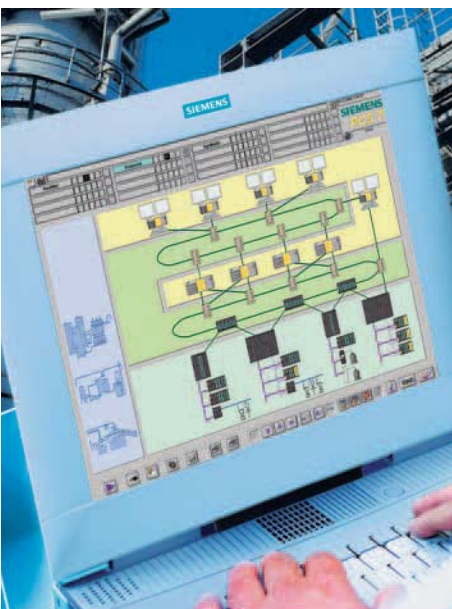

8/2	Introduction
8/3	Maintenance station



Asset Management

Introduction

Overview

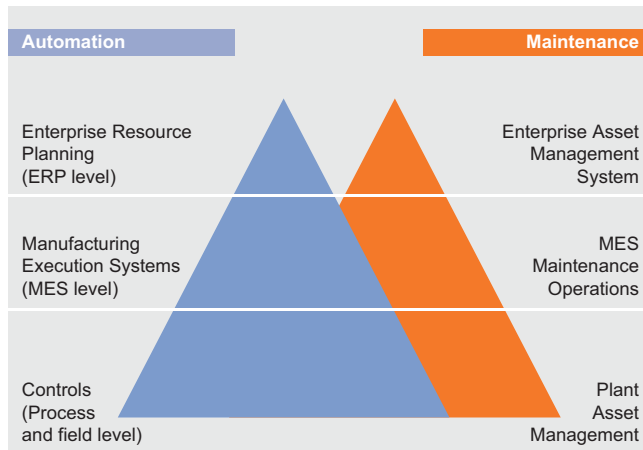

The PCS 7 Asset Management supplements SIMATIC PCS 7 by a valuable instrument for minimization of the total cost of ownership of a plant.

Asset management for plant engineering is understood to be the administration and management of the plant equipment, particularly the I&C equipment, as well as all activities and measures which serve to retain or increase the value of a plant. These primarily include:

- Corrective maintenance
Reaction to existing fault and diagnostics messages
- Preventive maintenance
Preventive diagnostics and maintenance
- Predictive maintenance
Predictive maintenance and diagnostics

Function

Maintenance functions and information are frequently only available in a separate level independent of the production. Parallel to process control, SIMATIC PCS 7 with the integral asset management system also provides uniform maintenance information and functions in the process control system for the system components of the plant (assets). Supplementary hardware or software tools for asset management functions are therefore superfluous.

Whereas the plant operator receives all information relevant to the process via the operator system and can specifically access the process, the maintenance engineer checks the hardware of the automation plant via the maintenance station, and processes its diagnostics messages and maintenance requests.

When implementing the SIMATIC PCS 7 asset management, consistent attention was paid to the conformity with international standards, specifications and recommendations. SIMATIC PCS 7 asset management takes into account e.g. the NAMUR requirements (process control standards committee in the chemical and pharmaceutical industries) defined in the following documents for systems for asset management at plant level and for status messages from field devices:

- NAMUR recommendation NE91 (requirements for systems for asset management at plant level)
- NAMUR recommendation NE 105 (requirements for the integration of fieldbus devices in engineering tools)
- NAMUR recommendation NE107 (status messages "Device failure", "Maintenance requirements", "Function check" from field devices).

In addition, it observes the IEC 61804-2 for describing devices by means of the Electronic Device Description Language (EDDL) and specifications made by the PROFIBUS & PROFINET International (PI) organization, e.g.:

- PROFIBUS Profile Guidelines Identification & Maintenance Functions
- PROFIBUS PA Profile for Process Control Devices

Integration

The SIMATIC PCS 7 Asset Management is integrated seamlessly into the SIMATIC PCS 7 process control system as a sector-independent software package. It consistently uses the hardware and software components of the engineering system and operator system.

The system interface for maintenance engineers is the maintenance station based on the engineering system (for details, see the next Section "Maintenance station").

Configuration

The PCS 7 Asset Management is based on the hardware and software project of the application which is generated during the standard configuration with the SIMATIC PCS 7 engineering system. Supported by the system, all data relevant to the PCS 7 asset management are derived from the project data of the application simply by pressing a button, and the diagnostics displays are also generated.

The procedure is simple, and no additional overhead is required for the asset management. It can be summarized as follows:

- Generation of the hardware and software project of the application
- System-supported generation of the diagnostics displays with all components present in the project, including the display hierarchy, according to the project's hardware structure. The names of the displays, symbols etc. imported from the project can be changed by users according to personal requirements or depending on project-specific features. These modifications are retained during further operations
- Compilation of the configuration data, and downloading to the operator station and maintenance station with subsequent test and commissioning phase.

Overview



The maintenance engineer can process the diagnostics messages and maintenance requests of the assets on the maintenance station. Via the maintenance station the engineer can access:

- Components of the process control system, e.g. intelligent field devices and I/O modules, fieldbus, controller, network components and plant bus as well as servers and clients of the operator systems
- Assets that do not belong directly to the process control system, such as pumps, motors, centrifuges, heat exchangers or control loops (passive or indirect assets). These are represented by proxy objects in which the diagnostics rules are stored.

The maintenance station for PCS 7 asset management uses hardware and software components of the engineering system and operator system. As a result of the close interlacing, ES, OS and asset management functions execute on common hardware. Such a multi-functional station cannot only be used for asset management, but also for system engineering or HMI.

The message system, user desktop, display hierarchy and operator prompting are oriented according to the HMI philosophy of the operator system. The diagnostics data of all assets are displayed on uniform faceplates whose contents depend on the intelligence of the respective component. This means that working with the maintenance station is simple and intuitive – complex familiarization is not required.

The diagnostics displays structured according to the plant hierarchy with the operating states of all PCS 7 components can be displayed on the maintenance station and also on an OS client. However, enhanced online diagnostics functions in conjunction with HW-Config or SIMATIC PDM can only be called from the maintenance station.

The user management and access control for the maintenance station accept the SIMATIC Logon integrated in SIMATIC PCS 7.

Design

Depending on the architecture of the SIMATIC PCS 7 plant, the maintenance station can be implemented based on a SIMATIC PCS 7 BOX RTX/416, PCS 7 single station or client/server combination.

The following table shows possible hardware/software configurations of the maintenance station (MS).

Required SIMATIC PCS 7 hardware/software	SIMATIC PCS 7 BOX RTX/416	SIMATIC PCS 7 ES single station	MS/ES client	MS server
Basic hardware				
SIMATIC PCS 7 BOX RTX/416 all-in-one system (Windows XP operating system)	●			
SIMATIC PCS 7 ES/OS 547B BCE/IE WXP (Windows XP operating system)		●	●	
SIMATIC PCS 7 OS Server 547B BCE/IE SRV03 (Windows Server 2003 operating system)				●
Required SIMATIC PCS 7 software corresponding to operating system or basic hardware (without taking into account the quantity frameworks)				
SIMATIC PCS 7 Engineering Software V7.0 AS/OS		●	●	
SIMATIC PDM PCS 7 V6.0 SP2 HF1 or higher	●	●	●	
SIMATIC PCS 7 OS Software Server V7.0				●
SIMATIC PCS 7 OS Software Client V7.0			●	
SIMATIC PCS 7 Asset Engineering V7.0	●	●	●	
SIMATIC PCS 7 Asset Runtime V7.0 (basic package and additional asset TAGs)	●	●		●

Two MS servers can also be operated as a redundant pair of servers. The redundant MS servers must be configured like redundant OS servers and expanded by the SIMATIC PCS 7 Asset Runtime software.

The SIMATIC PCS 7 Asset Runtime basic package already contains 100 asset TAGs. These can be expanded by cumulative SIMATIC PCS 7 Asset Runtime licenses for 10, 100 or 1000 asset TAGs (Count Relevant Licenses).

Maintenance station

Function

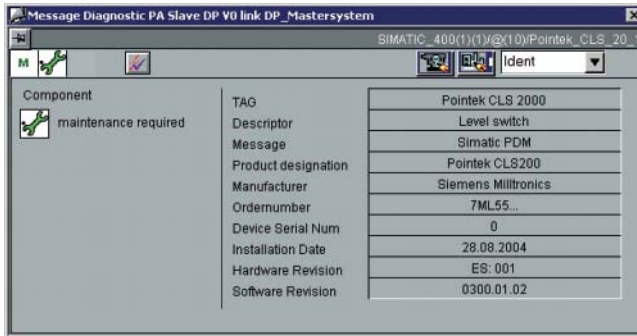

Diagnostics message of a component in the faceplate view "Identity"

The maintenance station provides comprehensive maintenance information for the system components of the plant (assets). In order to obtain information on the diagnostics status of individual plant areas or components, maintenance engineers can change from the overview display to the respective diagnostics display of the subordinate hardware level. If a fault is signaled in the overview display, the "loop in alarm" function permits rapid switching to the diagnostics faceplate of the associated component.

The scope of information available depends on the individual possibilities of the asset, and is filtered according to the user's area of responsibility.

The following information is available:

- Display of diagnostics status determined by the system
- Information on components such as tag name, vendor or serial number
- Display of diagnostics messages of a component
- Visualization of type and current state of initiated maintenance measure

Information on passive or indirect assets

For passive or indirect assets (pumps, motors, control loops etc.) without self-diagnostics, you can use the programmable logic block AssetMon to derive inadmissible operating states from various measured values and their deviations from a defined normal status and to display them as a maintenance alarm on the maintenance station. AssetMon is able to process up to 3 analog values and up to 16 binary values.

With the aid of the AssetMon, individual diagnostics structures, project-specific diagnostics rules and condition monitoring functions can also be implemented.

Enhanced information for assets according to IEC 61804-2

Further information can be called for assets described by the electronic device description (EDD) according to IEC 61804-2. This information is automatically read out of the components and made available by SIMATIC PDM in the background.

- Detailed diagnostics information
 - Device-specific information from the vendor
 - Information on fault diagnostics and troubleshooting
 - Additional documentation
- Results of internal condition monitoring functions
- Status information (e.g. local operation, local configuration changes)
- Display of modification logbook (audit trail) of the component with all entries on the persons, times and types of operator intervention on the component
- Parameter view of the assets (display of parameters saved in the component and in the project; if required, also differences between them)

Uniform symbols

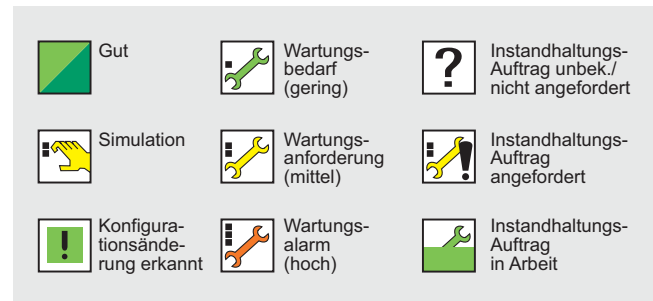

Uniform symbols for visualization of the maintenance status and for HMI on the maintenance station

A significant feature with visualization of the access management functionality is the uniform symbols and texts for displaying the statuses of all assets, i.e. for operator stations as well as for network components, controllers or field devices. The asset faceplates are also uniform. The amount of information displayed depends on the intelligence of the respective component.

Typical sequence of a maintenance cycle

- Intelligent sensors recognize the threat of failures by means of the implemented diagnostics system long before the actual failure, and can signal these.
- Diagnostics information on network components and basic PC devices is transferred to the maintenance station via an OPC SNMP link present in the assets.
- The symbol of the associated component (e.g. a field device) signals "Maintenance required" on the maintenance station. An entry is automatically made in the message log so that the chronology of occurred events can also be analyzed later. Parallel to this, the vendor's detailed diagnostics information is determined by means of SIMATIC PDM and the device description (EDD).
- On the overview display, maintenance engineers recognize "Maintenance required" in the technological plant. The maintenance engineers are rapidly guided to the corresponding device using standard mechanisms known from the operator station such as "Common display" and "Operator prompting using loop in alarm". Important information is then shown in the faceplate of the associated device, e.g. process tag number, location and device type.
- The existing detailed diagnostics information on the problem can then be called using the "Diagnostics" view depending on the device type and vendor, e.g. fault description, cause, trend information or handling instructions.
- They can assess the fault in the "Maintenance" view, and initiate corresponding reactions. This can be e.g. the input of a comment or handling instruction, the assignment of a work instruction number, or the increasing/decreasing of the maintenance requirement priority depending on the significance for the technological plant. Current working measures can also be traced/accompanied in this view. All operations can be logged. The log also contains the faceplate contents with ID data, messages, detailed diagnostics information, work instructions, notes and status.
- The work request with all information gained on the maintenance station is passed on to the corresponding maintenance department (identified by symbol "Maintenance order requested"). The release for maintenance of the component can also be made on the maintenance station (identified by symbol "Maintenance order being processed"). The current status of the maintenance measure is then indicated for all involved parties, and also for subsequent shifts.
- Once the maintenance measure has been carried out, it is concluded on the maintenance station – the status displays then return to the normal state. The complete maintenance cycle is documented on the maintenance station without gaps – automatically and without additional configuration overhead.

Selection and Ordering Data

Order No.

SIMATIC PCS 7 Asset Runtime Basic Package V7.0including SNMP OPC server license and 100 asset TAGs ¹⁾

For installation on SIMATIC PCS 7 BOX RTX/416, single station or server

6 languages (German, English, French, Italian, Spanish, Chinese), executes with Windows XP Professional or Windows Server 2003, single license for 1 installation

Type of delivery:
License key disk, certificate of license, terms and conditions**6ES7 658-7GB07-0YB0****SIMATIC PCS 7 Asset Runtime V7.0**

for expansion of asset TAGs

6 languages (German, English, French, Italian, Spanish, Chinese), executes with Windows XP Professional or Windows Server 2003, single license for 1 installation

Type of delivery:
License key disk, certificate of license, terms and conditions

- 10 asset TAGs
- 100 asset TAGs
- 1000 asset TAGs

6ES7 658-7GA07-2YB0**6ES7 658-7GB07-2YB0****6ES7 658-7GC07-2YB0****Asset engineering****SIMATIC PCS 7 Asset Engineering V7.0**

For installation on SIMATIC PCS 7 BOX 416, single station or client

6 languages (German, English, French, Italian, Spanish, Chinese), executes with Windows XP Professional / Server 2003, floating license for 1 user

Type of delivery:
License key disk, emergency key disk, certificate of license, terms and conditions**6ES7 658-7GX07-0YB5**

¹⁾ With asset TAGs, the number of asset objects monitored in SIMATIC PCS 7 is licensed. An asset object represents individual hardware components within a SIMATIC PCS 7 project, e.g.

- measuring devices, positioners, switchgear or remote I/O stations monitored per EDD or
- basic devices or Ethernet components monitored in the maintenance station via an SNMP OPC link.

The asset TAGs of the SIMATIC PCS 7 Asset Runtime licenses (groups of 10, 100 and 1000) are cumulative (Count Relevant Licenses).

Asset Management



8

Communication



9/2	Introduction
9/3	Industrial Ethernet
9/3	Introduction
9/6	SCALANCE X Industrial Ethernet switches
9/21	OSM/ESM/OMC Industrial Ethernet switches
9/23	Passive network components: FastConnect
9/25	Passive network components: ITP cables and connectors
9/26	Passive network components: Fiber-optic cables
9/28	System connection PCS 7 systems
9/30	Industrial Wireless LAN (IWLAN)
9/33	Industrial Security
9/33	Introduction
9/34	Industrial Security components
9/35	PROFIBUS
9/35	Introduction
	<u>PROFIBUS DP</u>
9/36	Introduction
9/37	Electrical networks
9/39	Optical networks with glass fiber-optic cables
9/40	Optical networks with plastic fiber-optic cables
9/41	AS connection
9/42	Y-Link
	<u>PROFIBUS PA</u>
9/43	Introduction
9/45	Routers: DP/PA link and DP/PA coupler
9/49	Active field distributor AFD and active field splitter AFS
9/50	FastConnect/SpliTConnect
9/51	Other communication
9/51	AS-Interface
9/52	Modbus



Introduction

Overview



The SIMATIC NET network components based on globally established standards provide SIMATIC PCS 7 with a powerful and rugged range of products for implementing totally integrated communications networks for reliable data exchange between all system components and levels of a plant.

The SIMATIC NET products specially developed for industrial applications are completely suitable for all types of plant in all industrial sectors. They are matched to one another and meet high standards, especially in areas where they are subject to extreme influences, such as

- interfering electromagnetic fields,
- corrosive liquids and atmospheres,
- explosion hazards,
- high mechanical loads.

The SIMATIC NET products guarantee expandability and safeguard investments through compatible further developments as well as uniformity from incoming goods to outgoing goods and from field devices up to the management information system.

Design

Incorporated in Totally Integrated Automation, the unique basis offered by Siemens for uniform automation of all sectors in the production, process or hybrid industries, the SIMATIC NET buses promote fast and reliable communication between the individual systems/applications of the SIMATIC PCS 7 process control systems such as:

- Automation systems, distributed I/Os and field components
- Asset management/engineering system and operator system
- SIMATIC BATCH and SIMATIC Route Control
- Process control via Internet/intranet and IT applications.

Industrial Ethernet is used as the plant bus as well as OS-LAN (terminal bus) for multi-user systems with client/server architecture. For small systems, the "Basic Communication Ethernet" (BCE) integrated in the SIMATIC PCS 7 Industrial Workstations permits operation of single stations and servers on the plant bus even without a CP 1613 communications processor.

In medium and large plants characterized by high requirements, SIMATIC PCS 7 applies modern Gigabit and FastEthernet technology which combines the high security provided by redundant optical rings with the scalable performance provided by switching technology and high transmission rates up to 1 Gbit/s.

PROFIBUS in the DP or PA version is used as the communications medium for interfacing intelligent distributed I/O devices, transmitters and actuators to the controller level. The rugged and reliable PROFIBUS is a universal, open fieldbus complying with the IEC 61158 and IEC 61784 international standards. In the PA version (which permits digital data transmission and power supply for the field devices on a two-wire cable), or with a series-connected isolating transformer (RS 485-iS coupler), it can be routed intrinsically-safe into hazardous areas of Zone 1.

Overview

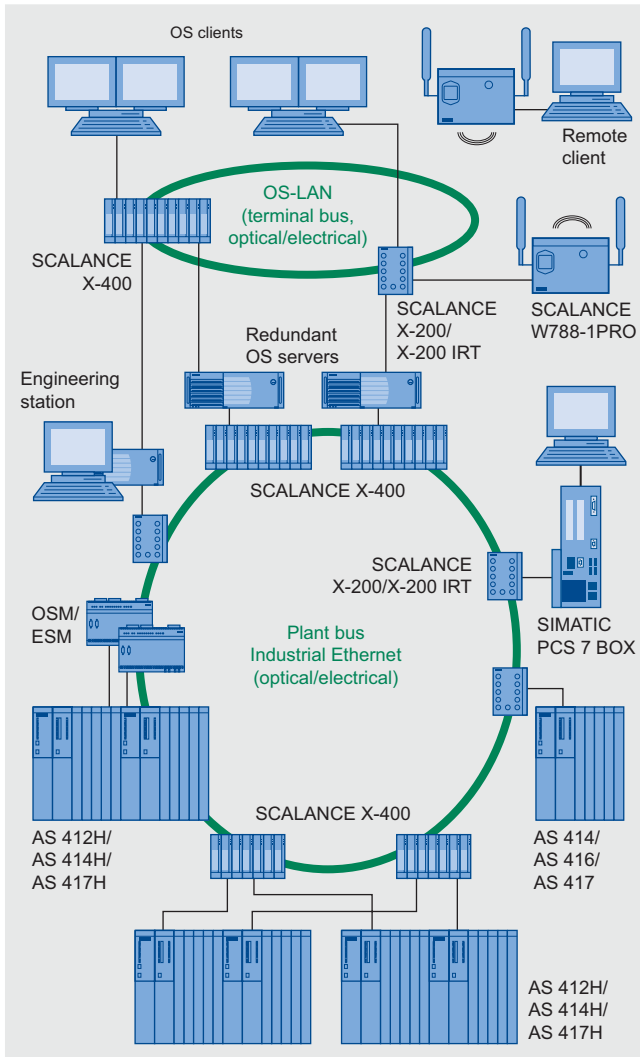

Industrial Ethernet, connection examples

The plant bus and the OS-LAN (terminal bus) for multi-user systems with client/server architecture are implemented with Industrial Ethernet, a powerful area and cell network for industrial applications in line with the international IEEE 802.3 standard (Ethernet). Bus structures with optical rings are particularly suitable for this because of their high noise immunity and high availability.

In medium-sized and large plants characterized by high requirements, SIMATIC PCS 7 applies modern Gigabit and FastEthernet technology. This combines the high reliability of optical rings with the scalable performance of switching technology and high transmission rates up to 1 Gbit/s.

Benefits

Ethernet currently has a market share of over 80% with a tendency to rise further, thus placing it in pole position in the global LAN landscape. Ethernet offers important characteristics that can give you significant advantages for your application:

- Fast commissioning through simple connections
- High flexibility since existing networks can be extended without any adverse effects
- High availability thanks to redundant network topologies
- Almost unlimited communications performance because scalable performance is available through switching technology if required
- Networking of different application areas such as office and production areas
- Investment protection through continuous and compatible further development
- Plant-wide clock system permits exact assignment of events within the complete plant

Ethernet technology for industrial environment

With Industrial Ethernet, SIMATIC NET expands the Ethernet technology by special components and capabilities for use in industrial environments:

- Network components for tough industrial environments
- Fast local assembly using the FastConnect cabling system with RJ45 technology
- Failsafe networks with fast switchover to redundant system (≤ 300 ms)
- Continuous monitoring of network components through a simple yet effective signaling concept
- Future-oriented network components with the SCALANCE X Ethernet product family

Communication

Industrial Ethernet

Introduction

Design

In the various SIMATIC PCS 7 subsystems (ES, OS, AS etc.) on-board interface modules, simple network cards or special communications processors (e.g. CP 1613) are used as communication interfaces. These are defined when selecting the respective system components depending on the requirements (for further information, refer to page 9/28).

The communication nodes are integrated into the bus with the aid of Industrial Ethernet switches. The modern Industrial Ethernet switches from the SCALANCE X range are to be recommended in particular. These offer scalable performance at an attractive price and support a wide variety of possible configurations. Further alternatives result by using the tried and tested ESM and OSM switches.

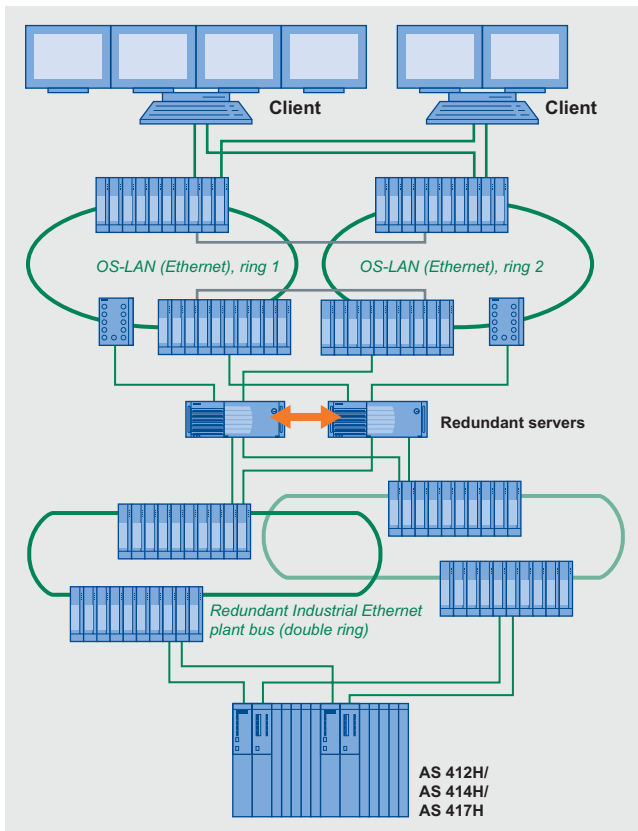

Example configuration with plant bus and OS LAN with two redundant rings

OS LAN (terminal bus)

Client-server and server-server communication is carried out on a dedicated Ethernet LAN. The communication network identified as OS LAN or terminal bus can be implemented with standard SIMATIC NET components such as switches, onboard interfaces, network cards, communications processors (CP), cables etc.

A ring design avoids communication failures if e.g. the line is damaged or opened at a particular point. To increase the availability even further, the OS LAN can also be distributed redundantly between two rings which are connected together by two pairs of switches (see example configuration). The switches from the SCALANCE X-400, X-300 and X-200 IRT ranges have the standby redundancy function required for this. Each of the redundant servers and clients can then be connected to both rings via two separate interface modules (redundant terminal bus adapter package). Communication is as standard on ring 1. Communication on ring 2 is only activated in the event of a fault on ring 1 which is relevant to the redundant switchover.

Industrial Ethernet plant bus

The automation systems (AS) communicate with one another and with the engineering system and operator systems (servers/single stations) over the Industrial Ethernet plant bus. This can be designed analogous to the OS LAN with standard SIMATIC NET components such as switches, network cards, communications processors (CP), cables etc. In the case of small plants with up to 8 standard automation systems per operator system, single stations and servers can be operated cost-effectively on the plant bus using "Basic Communication Ethernet" (BCE) and a FastEthernet network card. The CP 1613 communications processor is always required if more than 8 standard automation systems or fault-tolerant automation systems are used.

As far as availability is concerned, ring topologies are always the first choice for the plant bus. With particularly high availability requirements, the plant bus can also be configured as a redundant double ring (two CPs per AS CPU and OS server). Double faults such as a switch failure on ring 1 with a simultaneous interruption in the bus cable on ring 2 can then be tolerated. The two rings in such a configuration are physically separated. The coupling partners are linked together logically when configuring with NetPro over a fault-tolerant S7 connection (4-way redundancy). One switch each takes over the function of the redundancy manager for each ring. The current switches of the SCALANCE X-400, X-300, X-200 IRT and X-200 ranges can be used as the redundancy manager in a ring.

Note:

Detailed information on Industrial Ethernet and on the network components can be found in Catalog IK PI, in the A&D Mall, or in Catalog CA 01 under "Communication/Networks/SIMATIC NET communication systems".

Function

Decision aid for Industrial Ethernet switches

Different types of switches can be used for the Industrial Ethernet communication within the SIMATIC PCS 7 process control system. In addition to the OSM/ESM switches, these are currently the following switches:

SCALANCE X range	Switches
X-400	SCALANCE X414-3E and X408-2
X-300	SCALANCE X308-2, X308-2LD and X310
X-200	SCALANCE X224, X216, X208, X212-2, X212-2LD, X204-2 and X206-1LD
X-200 IRT	SCALANCE X204 IRT, X202-2 IRT, X202-2P IRT, X201-3P IRT and X200-4P IRT

In order to support you when selecting, the following list shows important properties of the various switch ranges.

SCALANCE X-400

- 1-Gbit ports and 100-Mbit ports (optical/electrical, number and version depend on device)
- Modular design for flexible electrical or optical Industrial Ethernet networks; variable network topology, type and number of ports (retrofitting of optical ports, extension by 8 further ports with X414-3E)
- Digital inputs
- Redundant 24 V DC supply
- Redundancy manager for the ring
- Standby redundancy (redundant connection between two rings)
- Many ports at one central position in the control cabinet
- IP20 protection
- Electrical 100-Mbit ports with collar for FastConnect cabling system
- Router functionality (X414-3E; connection of two subnets)
- Support of office standards such as virtual LANs incl. priority assignment (port-based VLANs), Rapid Spanning Tree (RSTP), Simple Network Management Protocol (SNMP) or IP Multicast filtering (e.g. for video applications) permits integration of automation networks into company networks
- Configuration of MAC address filters
- Slot numbering and labeling strips
- Option: C-PLUG swap medium for simple replacement of devices in event of fault

SCALANCE X-300

- Compact design
- IP30 protection
- Gigabit ports and FastEthernet ports (optical/electrical; version depends on device)
- 10 ports (3 x Gigabit and 7 x FastEthernet)
- Redundant 24 V DC supply
- Redundancy manager for the ring
- Standby redundancy between two rings
- Variable assembly (DIN rail, SIMATIC rail, horizontal and vertical wall mounting)
- Electrical ports with collar for FastConnect cabling system
- Option: C-PLUG swap medium for simple replacement of devices in event of fault

SCALANCE X-200 IRT

- Compact design
- IP30 protection
- 100-Mbit ports (electrical/optical; number and version depend on device)
- Max. 4 ports
- Redundant 24 V DC supply
- Redundancy manager for the ring
- Standby redundancy between two rings
- Variable assembly (DIN rail, SIMATIC rail, horizontal and vertical wall mounting)
- Electrical ports with collar for FastConnect cabling system
- Option: C-PLUG swap medium for simple replacement of devices in event of fault

SCALANCE X-200

- Compact design
- IP30 protection
- 100-Mbit ports (electrical/optical; number and version depend on device)
- 6 to 24 ports
- Redundant 24 V DC supply
- Redundancy manager for the ring
- Variable assembly (DIN rail, SIMATIC rail, horizontal and vertical wall mounting)
- Electrical ports with collar for FastConnect cabling system
- Operation of SCALANCE X208 in temperature range from -20 to +70 °C
- Option: C-PLUG swap medium for simple replacement of devices in event of fault

OSM/ESM

- Standby redundancy between two rings
- Redundancy manager for the ring
- Digital inputs
- Configuration of MAC address filters and had

Technical specifications

Plant bus / OS-LAN	Industrial Ethernet
Number of stations	1,023 per network segment (IEEE 802.3 standard)
Number of switches	Up to 50
Length of the network	
• Local network	Electrical: up to approx. 5 km Optical: up to approx. 150 km
• WAN	Worldwide with TCP/IP
Topology	Line, tree, ring, star

Communication

Industrial Ethernet

SCALANCE X Industrial Ethernet switches

Overview



Switches are active network components that specifically distribute data to the relevant addressees. SCALANCE X is the modern range of Industrial Ethernet switches from SIMATIC NET. The SCALANCE X family comprises product lines that complement each other and are carefully tuned to the specific automation task.

Application

The products referred to below from the SCALANCE X-400, X-300, X-200 IRT and X-200 ranges are suitable for use in SIMATIC PCS 7 systems.

SCALANCE X-400

SCALANCE X-400 switches are suitable for designing a plant bus and OS-LAN (terminal bus) with an electrical or optical Gigabit ring technology (non-redundant and redundant rings).

- SCALANCE X414-3E with 2 Gigabit Ethernet ports (electrical/optical), 12 electrical FastEthernet ports and optionally 4 optical FastEthernet ports (BFOC); can be expanded by extender module with 8 electrical or 8 optical FastEthernet ports (BFOC)
- SCALANCE X408-2 with 4 Gigabit Ethernet ports (electrical/optical) and 4 FastEthernet ports (electrical/optical)

Both versions permit a maximum communications performance, in particular with very large plants with comprehensive quantity frameworks and expansive communication networks.

SCALANCE X-300

SCALANCE X-300 switches can be used to implement Industrial Ethernet structures with a line, star or ring topology (non-redundant and redundant rings) with transmission rates up to 1000 Mbit/s.

- SCALANCE X310 with 3 electrical Gigabit Ethernet RJ45 ports and 7 electrical FastEthernet RJ45 ports
- SCALANCE X308-2 with 2 optical Gigabit Ethernet SC ports for glass multimode FO cables, 1 electrical Gigabit Ethernet RJ45 port and 7 electrical FastEthernet RJ45 ports
- SCALANCE X308-2LD with 2 optical Gigabit Ethernet SC ports for glass multimode FO cables, 1 electrical Gigabit Ethernet RJ45 port and 7 electrical FastEthernet RJ45 ports

SCALANCE X-200 IRT

SCALANCE X-200 IRT switches are used for Industrial Ethernet structures with a line, star or ring topology (non-redundant and redundant rings) with transmission rates up to 100 Mbit/s.

- SCALANCE X204 IRT with 4 electrical RJ45 ports
- SCALANCE X202-2 IRT with 2 electrical RJ45 ports and 2 optical BFOC ports for glass multimode FO cables
- SCALANCE X202-2P IRT with 2 electrical RJ45 ports and 2 POF (polymer optical fiber) ports
- SCALANCE X201-3P IRT with 1 electrical RJ45 port and 3 POF ports
- SCALANCE X200-4P IRT with 4 POF ports

SCALANCE X-200

SCALANCE X-200 switches are suitable for Industrial Ethernet structures with a line, star or ring topology with transmission rates up to 100 Mbit/s (non-redundant and redundant rings). However, they do not have a standby redundancy functionality (see table with product characteristics).

- SCALANCE X208 with 8 electrical RJ45 ports
- SCALANCE X204-2 with 2 optical glass FO ports and 4 electrical RJ45 ports
- SCALANCE X224 with 24 electrical RJ45 ports
- SCALANCE X216 with 16 electrical RJ45 ports
- SCALANCE X208 with 8 electrical RJ45 ports
- SCALANCE X204-2 with 4 electrical RJ45 ports and 2 optical BFOC ports for glass multimode FO cables
- SCALANCE X212-2 with 12 electrical RJ45 ports and 2 optical BFOC ports for glass multimode FO cables
- SCALANCE X212-2LD with 12 electrical RJ45 ports and 2 optical BFOC ports for glass singlemode FO cables
- SCALANCE X206-1LD with 6 electrical RJ45 ports and 1 optical BFOC port for glass singlemode FO cables

SCALANCE X Industrial Ethernet switches

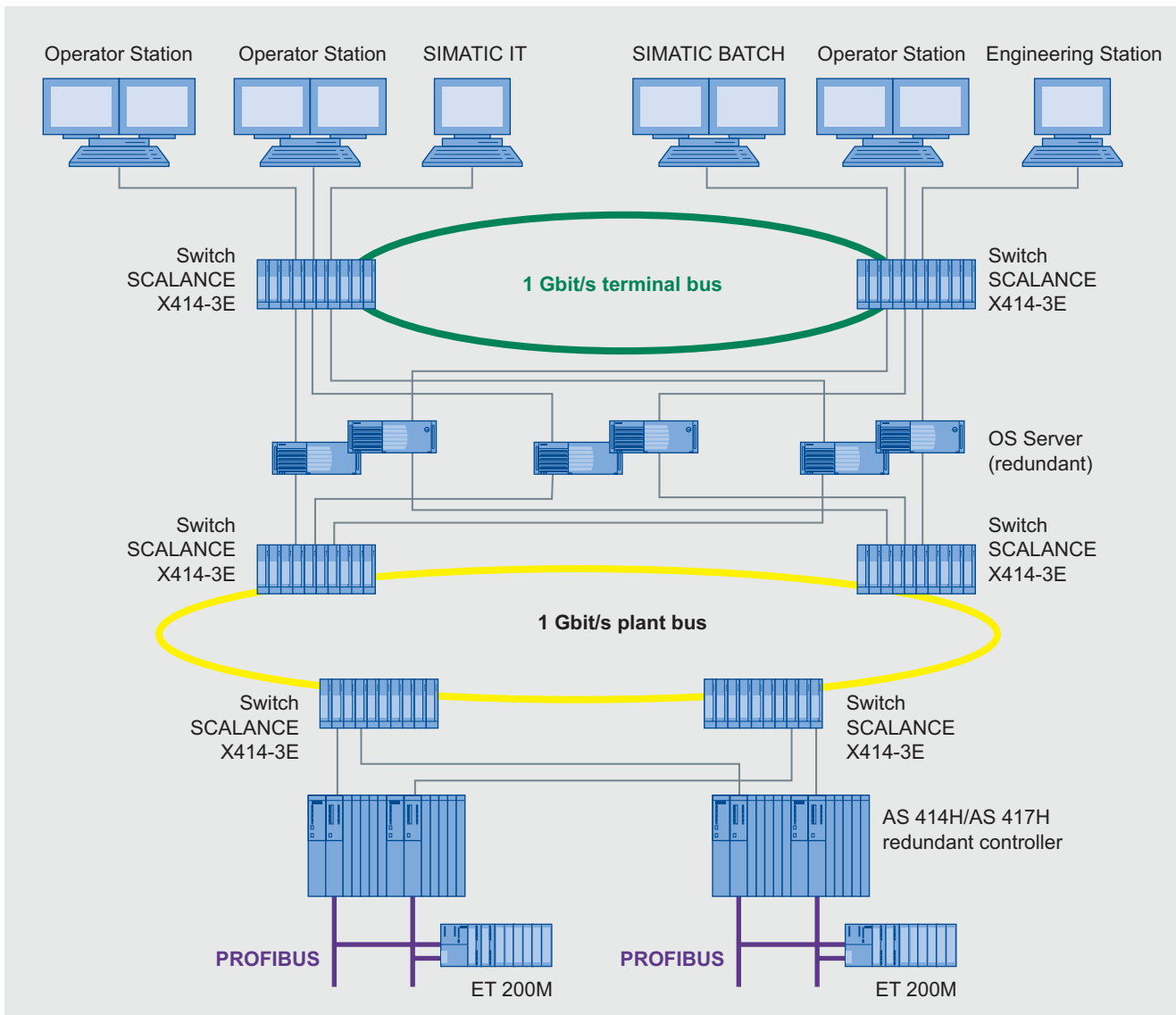

Example of the use of SCALANCE X414-3E switches in the SIMATIC PCS 7 process control system

Communication Industrial Ethernet

SCALANCE X Industrial Ethernet switches

Design

Product characteristics

Features	X414-3E	X408-2	X310, X308-2, X308-2LD	X204 IRT, X202-2 IRT, X202-2P IRT	X201-3P IRT, X200-4P IRT	X224, X216	X212-2, X212-2LD	X208, X206-1LD, X204-2
Compact enclosure			•	•	•	•	•	•
LED diagnostics	•	•	•	•	•	•	•	•
SIMATIC world	•	•	•	•	•	•	•	•
2 x 24 V DC	•	•	•	•	•	•	•	•
Signaling contact	•	•	•	•	•	•	•	•
Local display (set button)	•	•	•	•	•	•	•	•
Diagnostics: Web, SNMP	•	•	•	•	•	•	•	•
PROFINET diagnostics	•	•	•	•	•	•	•	•
C-PLUG	•	•	•	•	•	•	•	•
Ring redundancy with RM	•	•	•	•	•	•	•	•
Standby redundancy	•	•	•	•	•			
IRT capability				•	•			
Gigabit technology	•	•	•					
Modular design	•	•						
Digital inputs	8							
IT features (VLAN, RSTP, IGMP, ...)	•	•	•					
Layer 3 switching (IP routing)	•							

Summary of interfaces

Module type	Type and number of ports				
	Gigabit Ethernet 1000 Mbit/s		Fast Ethernet 100 Mbit/s		
	Electrical (TP)	Optical (FO)	Electrical (TP)	Optical (FO)	
	RJ45 socket	SC socket	RJ45 socket	Plastic FO: (POF/PCF) SC RJ socket	Glass FO: ST socket (BFOC connection)
X414-3E (Gigabit ports either optical or electrical)	2	2 (multimode or singlemode)	12 / 20 ¹⁾	–	4 ²⁾ / 12 ³⁾ (multimode or singlemode)
X408-2 (Gigabit and FastEthernet ports each either optical or electrical)	4	4 (multimode or singlemode)	4	–	4 ²⁾ (multimode or singlemode)
X310	3	–	7	–	–
X308-2	1	2 (multimode)	7	–	–
X308-2LD	1	2 (singlemode)	7	–	–
X204 IRT	–	–	4	–	–
X202-2 IRT (optical and electrical ports additive)	–	–	2	–	2 (multimode)
X202-2P IRT (optical and electrical ports additive)	–	–	2	2	–
X201-3P IRT (optical and electrical ports additive)	–	–	1	3	–
X200-4P IRT	–	–	–	4	–
X224	–	–	24	–	–
X216	–	–	16	–	–
X212-2	–	–	12	–	2 (multimode)
X212-2LD	–	–	12	–	2 (singlemode)
X208	–	–	8	–	–
X206-1LD	–	–	6	–	1 (singlemode)
X204-2 (optical and electrical ports additive)	–	–	4	–	2 (multimode)

¹⁾ With additional EM495-8 extender module

²⁾ 2 additive plug-on media modules

³⁾ With EM496-4 extender module and 4 plug-on media modules additive to 2)

SCALANCE X Industrial Ethernet switches



SCALANCE X414-3E and X408-2

- Modular switches with IP20 protection for installation in control cabinets; can be combined with media modules (X414-3E and X408-2) and extenders (only X414-3E)
- Mounting possibilities: SIMATIC S7-300 rail or 35 mm DIN rail
- Redundant 24 V DC supply
- 10/100/1000 Mbit/s technology for different transmission media (8-core electric, twisted-pair or fiber-optic, multimode/singlemode)
- Two (X414-3E) or four (X408-2) integral Gigabit Ethernet twisted-pair interfaces (10/100/1000 Mbit/s, RJ45 sockets) for connecting several switches together
- Node connection via 12 (X414-3E) or 4 (X408-2) Fast Ethernet twisted-pair ports integrated in the switch (10/100 Mbit/s; RJ45 sockets with retaining collar)
- Extender interface for expansion by 8 Fast Ethernet ports (only X414-3E):
 - Electrical ports with Fast Ethernet extender (can be docked on right of switch) or
 - optical ports with module extender and media modules
- Implementation of optical Gigabit rings with 2-port Gigabit Ethernet media module for conversion of integral Gigabit Ethernet ports to fiber-optic conductors (FOC):
 - Module version for multimode (1000BaseSX ports for up to 750 m FOC) and
 - singlemode (up to 70 km FOC, see Catalog IK PI)
- SCALANCE X414-3 has 2 slots for optical Fast Ethernet media modules with 2 ports, SCALANCE X408-2 has 2 universal slots which can be alternatively used for optical Fast Ethernet or Gigabit Ethernet media modules with 2 ports
- Integration in optical 100-Mbit/s rings using plug-in 2-port Fast Ethernet media module for multi-mode FOC (up to 3 km) or alternatively single-mode FOC (up to 26 km)
- Optical interfacing of remote nodes via a second plug-in 2-port FOC media module for Fast Ethernet
- Hot swapping of extenders (only X414-3) and media modules
- Max. cable lengths between two modules for communication via multimode FOC (for cables, see page 9/26):
 - Up to 3000 m via 100BaseFX ports (100 Mbit/s)
 - Up to 750 m via 1000BaseSX ports (1000 Mbit/s)
- Max. cable lengths between two modules for communication via twisted-pair (for cables, see page 9/25):
 - Up to 100 m via 10/100BaseTX (10/100 Mbit/s) or 1000BaseTX Ports (1000 Mbit/s)

- Detection of failure of a transmission link or a switch in the ring, and activation of the replacement link within 0.3 s (also in large networks):
 - With Gigabit Ethernet (SCALANCE X-400 switches in ring) just like
 - with Fast Ethernet (SCALANCE X-200, X-200 IRT or OSM/ESM)
- Standby functionality for redundant connection of two rings
- Slot numbering and labeling strips for unambiguous port identification
- Suitable for operating temperatures from 0 to +60 °C

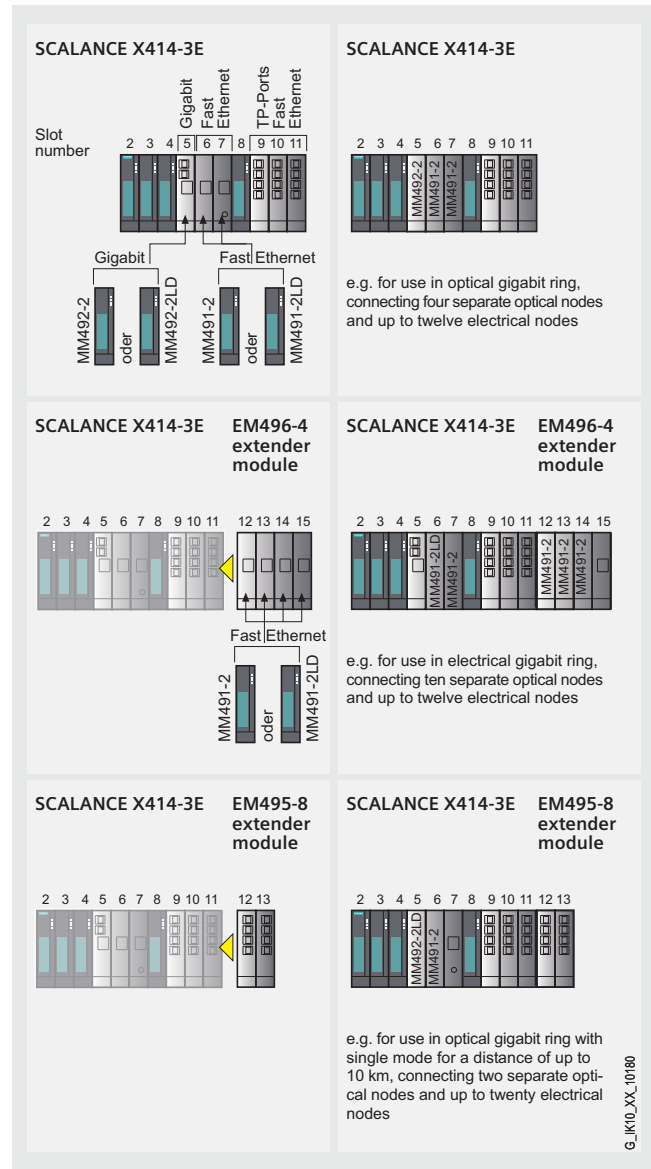

Possible applications of media and extender modules with SCALANCE X-414-3

Communication

Industrial Ethernet

SCALANCE X Industrial Ethernet switches

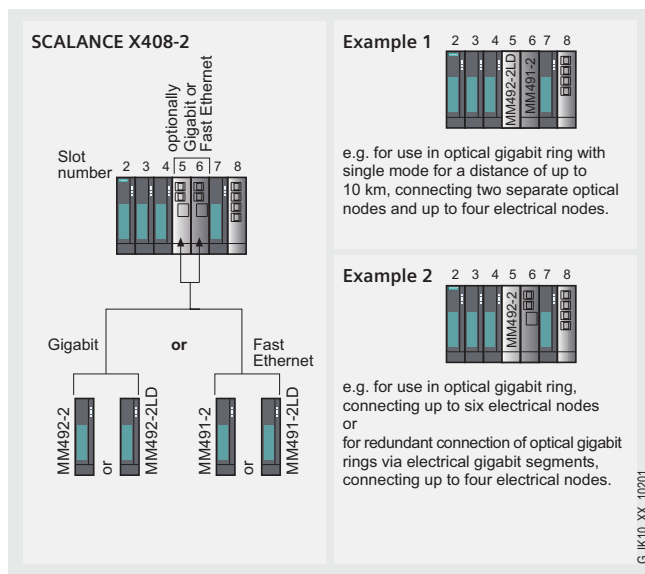

Possible applications of media modules with SCALANCE X-408-2

SCALANCE X-300



With the X310, X308-2 and X308-2LD switches from the SCALANCE X-300 range, it is possible to implement line and star topologies as well as low-cost electrical or optical ring topologies with transmission rates up to 1000 Mbit/s. All switches can be used in the ring as redundancy managers. They additionally support standby redundancy for bus configurations with two redundant rings. As a redundancy manager, an X-300 switch monitors the SCALANCE X switches connected via its ring ports, and switches without interruption to the substitute link on failure of a transmission link or a switch in the ring. Each X-300 switch has 3 Gigabit Ethernet ports and 7 FastEthernet ports which are designed as follows depending on the device type:

- SCALANCE X310 with
 - 3 electrical Gigabit Ethernet RJ45 ports (1000BaseTX)
 - 7 electrical FastEthernet RJ45 ports (10/100BaseTX)

- SCALANCE X308-2 with
 - 2 optical Gigabit Ethernet SC ports for glass multimode FOC (1000BaseSX)
 - 1 electrical Gigabit Ethernet RJ45 port (1000BaseTX)
 - 7 electrical FastEthernet RJ45 ports (10/100BaseTX)
- SCALANCE X308-2LD with
 - 2 optical Gigabit Ethernet SC ports for glass singlemode FOC (1000BaseFX)
 - 1 electrical Gigabit Ethernet RJ45 port (1000BaseTX)
 - 7 electrical FastEthernet RJ45 ports (10/100BaseTX)

Features of the X-300 switches

- Rugged metal enclosure of S7-300 format, IP30 protection, for installation in control cabinets
- Mounting possibilities: DIN rail, SIMATIC S7-300 rail, direct wall mounting
- Redundant 24 V DC supply
- Cable length between two devices with electrical transmission per TP ports 1000BaseTX with RJ45 sockets:
 - Depending on the cable type, up to 90 m with IE FC cable, IE FC RJ45 Modular Outlet and patch cable, up to 10 m with TP-Cord (see page 9/23)
- Cable length between two devices with optical transmission:
 - Up to 750 m via 1000BaseSX ports (1000 Mbit/s) and Industrial Ethernet glass multimode FOC (see page 9/26 or in Catalog IK PI)
 - Up to 10 km via 1000BaseFX ports (1000 Mbit/s) and Industrial Ethernet glass singlemode FOC (see Section "Passive network components" in Catalog IK PI)
- Cable length between two devices with electrical transmission per TP ports 10/100BaseTX with RJ45 sockets:
 - Depending on the cable type, up to 100 m with IE FC cable and IE FC RJ45 Plugs (see page 9/23 or in Catalog IK PI)
 - Up to 10 m with TP-Cord (see Section "Passive network components" in Catalog IK PI)
- Permissible operating temperature for all device types: 0 to +60°C

SCALANCE X Industrial Ethernet switches

SCALANCE X-200 IRT



With the X204 IRT, X202-2 IRT, X202-2P IRT, X201-3P IRT and X200-4P IRT switches from the SCALANCE X-200 IRT range, it is possible to implement line and star topologies as well as low-cost electrical or optical ring topologies with transmission rates up to 100 Mbit/s. All switches can be used in the ring as redundancy managers, and additionally support the standby redundancy for bus configurations with two redundant rings. As a redundancy manager, an X-200 IRT switch monitors the SCALANCE X switches connected via its ring ports, and switches without interruption to the substitute link on failure of a transmission link or a switch in the ring. Each X-200 IRT switch has 4 FastEthernet ports which are designed as follows depending on the device type:

- SCALANCE X204 IRT with
 - 4 electrical RJ45 ports (10/100BaseTX)
- SCALANCE X202-2 IRT with
 - 2 electrical RJ45 ports (10/100BaseTX)
 - 2 optical BFOC ports (100BaseFX) for glass multimode FOC
- SCALANCE X202-2P IRT with
 - 2 electrical RJ45 ports (10/100BaseTX)
 - 2 optical POF (Polymer Optical Fiber) ports
- SCALANCE X201-3P IRT with
 - 1 electrical RJ45 port (10/100BaseTX)
 - 3 optical POF ports
- SCALANCE X200-4P IRT with
 - 4 optical POF ports

Features of the X-200 IRT switches

- Rugged metal enclosure of S7-300 format, IP30 protection, for installation in control cabinets
- Mounting possibilities: DIN rail, SIMATIC S7-300 rail, direct wall mounting
- Redundant 24 V DC supply
- Cable length between two devices with electrical transmission per TP ports 10/100BaseTX with RJ45 sockets:
 - Depending on the cable type, up to 100 m with IE FC cable and IE FC RJ45 Plugs (see page 9/23 or in Catalog IK PI)
 - Up to 10 m with TP-Cord (see Section "Passive network components" in Catalog IK PI)
- Cable length of a segment with optical transmission:
 - Up to 3 km via 100BaseFX ports with BFOC socket (corresponds to ST socket) and Industrial Ethernet glass multimode FOC (see page 9/26 or in Catalog IK PI)
 - Up to 100 m via POF ports and Industrial Ethernet PCF (Polymer Cladded Fiber) (see Section "Passive network components" in Catalog IK PI)
 - Up to 50 m via POF ports and Industrial Ethernet POF (Polymer Optical Fiber) (see Section "Passive network components" in Catalog IK PI)
- The permissible operating temperatures vary as follows depending on the device type:
 - -20 to +70°C (X204 IRT)
 - -10 to +60°C (X202-2-IRT)
 - 0 to +60°C (X202-2P IRT)
 - 0 to +50°C (X201-3P IRT)
 - 0 to +40°C (X200-4P IRT)

SCALANCE X-200



With the X208, X216, X224, X204-2, X212-2, X212-2LD and X206-1LD switches from the SCALANCE X-200 range, it is possible to implement line and star topologies as well as low-cost electrical or optical ring topologies with transmission rates up to 100 Mbit/s. All switches can be used in the ring as redundancy managers. As a redundancy manager, an X-200 switch monitors the SCALANCE X switches connected via its ring ports, and switches without interruption to the substitute link on failure of a transmission link or a switch in the ring.

Communication

Industrial Ethernet

SCALANCE X Industrial Ethernet switches

The SCALANCE X-200 switches have 6 to 24 FastEthernet ports which are designed as follows depending on the device type:

- SCALANCE X224 with
 - 24 electrical RJ45 ports (10/100BaseTX)
- SCALANCE X216 with
 - 16 electrical RJ45 ports (10/100BaseTX)
- SCALANCE X208 with
 - 8 electrical RJ45 ports (10/100BaseTX)
- SCALANCE X204-2 with
 - 4 electrical RJ45 ports (10/100BaseTX)
 - 2 optical BFOC ports (100BaseFX) for glass multimode FOC
- SCALANCE X212-2 with
 - 12 electrical RJ45 ports (10/100BaseTX)
 - 2 optical BFOC ports (100BaseFX) for glass multimode FOC
- SCALANCE X212-2LD with
 - 12 electrical RJ45 ports (10/100BaseTX)
 - 2 optical BFOC ports (100BaseFX) for glass singlemode FOC
- SCALANCE X206-1LD with
 - 6 electrical RJ45 ports (10/100BaseTX)
 - 1 optical BFOC port (100BaseFX) for glass singlemode FOC

Features of the X-200 switches

- Rugged metal enclosure of S7-300 format, IP30 protection, for installation in control cabinets
- Mounting possibilities: DIN rail, SIMATIC S7-300 rail, direct wall mounting
- Redundant 24 V DC supply
- Cable length between two devices with electrical transmission per TP ports 10/100BaseTX with RJ45 sockets:
 - Depending on the cable type, up to 100 m with IE FC cable and IE FC RJ45 Plugs (see page 9/23 or in Catalog IK PI)
 - Up to 10 m with TP-Cord (see Section "Passive network components" in Catalog IK PI)
- Cable length of a segment with optical transmission via 100BaseFX ports with BFOC socket (corresponds to ST socket):
 - Up to 3 km with Industrial Ethernet glass multimode FOC (see page 9/26 or in Catalog IK PI)
 - Up to 26 km with Industrial Ethernet glass singlemode FOC (see Section "Passive network components" in Catalog IK PI)
- The permissible operating temperatures vary depending on the device type:
 - -20 to +70°C (X208)
 - -10 to +60°C (X204-2)
 - 0 to +60°C (all others)

Technical specifications

Type	SCALANCE X414-3E	SCALANCE X408-2
Transmission rate	10/100/1000 Mbit/s	10/100/1000 Mbit/s
Interfaces		
• Communications connection, electrical (see also table "Summary of interfaces")	In the basic device: 2 x RJ45 (10/100/1000 Mbit/s; TP); 12 x RJ45 (10/100 Mbit/s; TP) With extender modules: 8 x RJ45 (10/100 Mbit/s; TP) via EM495-8	4 x RJ45 (10/100/1000 Mbit/s; TP); 4 x RJ45 (10/100 Mbit/s; TP)
• Communications connection, optical (see also table "Summary of interfaces")	In the basic device: up to 2 x glass FOC with SC sockets (1000 Mbit/s) via MM492-2, MM492-2LD, MM492-2LH or MM492-2LH+ media module; or up to 4 x glass FOC with BFOC sockets (100 Mbit/s) via MM491-2 or MM491-2LD media module With extender modules: up to 12 x glass FOC with BFOC sockets (100 Mbit/s) via EM496-4 and MM491-2 or MM491-2LD	Up to 4 x glass FOC with SC sockets (1000 Mbit/s) via MM492-2 or MM492-2LD media module; or up to 4 x glass FOC with BFOC sockets (100 Mbit/s) via MM491-2 or MM491-2LD media module
• Extender interface	EM495-8 or EM496-4	--
• Connection for power supply	1 x 4-contact terminal block	1 x 4-contact terminal block
• Connection for signaling contact	1 x 4-contact terminal block	1 x 4-contact terminal block
• Connection for digital input signals	2 x 5-contact terminal block	--
• Slot for swap medium	C-PLUG	C-PLUG
Power supply	2 x 24 V DC (18 to 32 V)	2 x 24 V DC (18 to 32 V)
Current consumption	< 2000 mA	< 700 mA
Power loss at 24 V DC	15 W (without media and extender modules), < 48 W (maximum configuration)	15 W (without media modules), < 48 W (maximum configuration)

Type	SCALANCE X414-3E	SCALANCE X408-2
Network size parameters / TP cable length		
• 0 to 55 m	IE TP Torsion Cable with IE FC RJ45 Plug	IE TP Torsion Cable with IE FC RJ45 Plug
• 0 to 85 m	IE FC Marine/ Trailing/ Flexible/ FRNC Cable with IE FC RJ45 Plug	IE FC Marine/ Trailing/ Flexible/ FRNC Cable with IE FC RJ45 Plug
• 0 to 100 m	IE FC Standard Cable GP with IE FC RJ45 Plug	IE FC Standard Cable GP with IE FC RJ45 Plug
• 0 to 750 m	Cable length multimode FOC at 1000 Mbit/s; MM492-2 with glass FOC 50/125 µm; ≤ 2.7 dB/km with 850 nm; ≥ 600 MHz x km	Cable length multimode FOC at 1000 Mbit/s; MM492-2 with glass FOC 50/125 µm; ≤ 2.7 dB/km with 850 nm; ≥ 600 MHz x km
• 0 to 3000 m	Cable length multimode FOC at 100 Mbit/s; MM491-2 with glass FOC 62.5/125 µm or 50/125 µm; ≤ 1 dB/km with 1300 nm; ≥ 600 MHz x km	Cable length multimode FOC at 100 Mbit/s; MM491-2 with glass FOC 62.5/125 µm or 50/125 µm; ≤ 1 dB/km with 1300 nm; ≥ 600 MHz x km
• 0 to 10 km	Cable length singlemode FOC at 1000 Mbit/s; MM492-2LD with glass FOC 10/125 µm or 9/125 µm; ≤ 0.5 dB/km with 1300 nm	Cable length singlemode FOC at 1000 Mbit/s; MM492-2LD with glass FOC 10/125 µm or 9/125 µm; ≤ 0.5 dB/km with 1300 nm
• 0 to 26 km	Cable length singlemode FOC at 100 Mbit/s; MM491-2LD with glass FOC 10/125 µm or 9/125 µm; ≤ 0.5 dB/km with 1300 nm	Cable length singlemode FOC at 100 Mbit/s; MM491-2LD with glass FOC 10/125 µm or 9/125 µm; ≤ 0.5 dB/km with 1300 nm
• 0 to 40 km	Cable length singlemode FOC at 1000 Mbit/s; MM492-2LH with glass FOC 10/125 µm or 9/125 µm; ≤ 0.5 dB/km with 1300 nm	Cable length singlemode FOC at 1000 Mbit/s; MM492-2LH with glass FOC 10/125 µm or 9/125 µm; ≤ 0.5 dB/km with 1300 nm
• 0 to 70 km	Cable length singlemode FOC at 1000 Mbit/s; MM492-2LH+ with glass FOC 10/125 µm or 9/125 µm; ≤ 0.5 dB/km with 1300 nm	Cable length singlemode FOC at 1000 Mbit/s; MM492-2LH+ with glass FOC 10/125 µm or 9/125 µm; ≤ 0.5 dB/km with 1300 nm
Permissible ambient conditions		
• Operating temperature	0 to +60 °C	0 to +60 °C
• Transport/storage temperature	-40 °C to +80 °C	-40 °C to +80 °C
• Relative humidity during operation	< 95% (no condensation)	< 95% (no condensation)
Design		
• Dimensions (W x H x D) in mm	344 x 145 x 117	275 x 145 x 117
• Weight	3.1 kg	1.9 kg
• Mounting	S7-300 rail, DIN rail	S7-300 rail, DIN rail
Degree of protection	IP20	IP20
Approvals		
• Radio interference suppression level	EN 61000-6-4 Class A	EN 61000-6-4 Class A
• Noise immunity	EN 61000-6-2	EN 61000-6-2
• cUL-Listung	UL 60950-1, CSA C22.2 No. 60950-1, UL 508, CSA C22.2 No. 14-M91, UL 1604 and 2279 (Hazardous Location)	UL 60950-1, CSA C22.2 No. 60950-1, UL 508, CSA C22.2 No. 14-M91, UL 1604 and 2279 (Hazardous Location)
• FM	FM 3611, FM Hazardous Location	FM 3611, FM Hazardous Location
• ATEX Zone 2	EN 50021	EN 50021
• C-Tick	AS/NZS 2064 (Class A)	AS/NZS 2064 (Class A)
• CE	EN 61000-6-2, EN 61000-6-4	EN 61000-6-2, EN 61000-6-4
• Shipbuilding approvals	<ul style="list-style-type: none"> • Germanischer Lloyd (GL) • American Bureau of Shipping (ABS) • Llyods Register of Shipping (LRS) • Bureau Veritas (BV) • Nippon Kaiji Kyokai (NK) • Det Norske Veritas (DNV) 	Available soon

Communication

Industrial Ethernet

SCALANCE X Industrial Ethernet switches

Type	SCALANCE X310	SCALANCE X308-2	SCALANCE X308-2LD
Transmission rate	10/100/1000 Mbit/s	10/100/1000 Mbit/s	10/100/1000 Mbit/s
Interfaces			
• Communications connection, electrical (see also table "Summary of interfaces")	3 x RJ45 (10/100/1000 Mbit/s; TP) 7 x RJ45 (10/100 Mbit/s; TP)	1 x RJ45 (10/100/1000 Mbit/s; TP) 7 x RJ45 (10/100 Mbit/s; TP)	1 x RJ45 (10/100/1000 Mbit/s; TP) 7 x RJ45 (10/100 Mbit/s; TP)
• Communications connection, optical (see also table "Summary of interfaces")	--	2 x glass FO cable (multimode) with SC socket (1000 Mbit/s)	2 x glass FO cable (single-mode) with SC socket (1000 Mbit/s)
• Connection for power supply	1 x 4-contact terminal block	1 x 4-contact terminal block	1 x 4-contact terminal block
• Connection for signaling contact	1 x 2-contact terminal block	1 x 2-contact terminal block	1 x 2-contact terminal block
• Slot for swap medium	C-PLUG	C-PLUG	C-PLUG
Power supply	2 x 24 V DC (18 to 32 V)	2 x 24 V DC (18 to 32 V)	2 x 24 V DC (18 to 32 V)
Current consumption	400 mA	400 mA	400 mA
Power loss at 24 V DC	9.6 W	9.6 W	9.6 W
Network size parameters / TP cable length			
• 0 to 55 m	IE TP Torsion Cable with IE FC RJ45 Plug IE FC Outlet RJ45 with IE TP Torsion Cable (0 to 45 m) + 10 m TP Cord	IE TP Torsion Cable with IE FC RJ45 Plug IE FC Outlet RJ45 with IE TP Torsion Cable (0 to 45 m) + 10 m TP Cord	IE TP Torsion Cable with IE FC RJ45 Plug IE FC Outlet RJ45 with IE TP Torsion Cable (0 to 45 m) + 10 m TP Cord
• 0 to 85 m	IE FC Marine/ Trailing/ Flexible/ FRNC Cable with IE FC RJ45 Plug IE FC Outlet RJ45 with IE FC Marine/Trailing/Flexible Cable (0 to 75 m) + 10 m TP Cord	IE FC Marine/ Trailing/ Flexible/ FRNC Cable with IE FC RJ45 Plug IE FC Outlet RJ45 with IE FC Marine/Trailing/Flexible Cable (0 to 75 m) + 10 m TP Cord	IE FC Marine/ Trailing/ Flexible/ FRNC Cable with IE FC RJ45 Plug IE FC Outlet RJ45 with IE FC Marine/Trailing/Flexible Cable (0 to 75 m) + 10 m TP Cord
• 0 to 100 m	IE FC Standard Cable GP with IE FC RJ45 Plug IE FC Outlet RJ45 with IE FC TP Standard Cable GP (0 to 90 m) + 10 m TP Cord	IE FC Standard Cable GP with IE FC RJ45 Plug IE FC Outlet RJ45 with IE FC Standard Cable GP (0 to 90 m) + 10 m TP Cord	IE FC Standard Cable GP with IE FC RJ45 Plug IE FC Outlet RJ45 with IE FC Standard Cable GP (0 to 90 m) + 10 m TP Cord
• 0 to 750 m	--	Cable length multimode FOC at 1000 Mbit/s; glass FOC 50/125 µm; ≤ 2.7 dB/km with 850 nm; ≥ 600 MHz x km	--
• 0 to 10 km	--	--	Cable length singlemode FOC at 1000 Mbit/s; 10/125 µm or 9/125 µm; ≤ 0.5 dB/km with 1300 nm
Permissible ambient conditions			
• Operating temperature	0 to +60 °C	0 to +60 °C	0 to +60 °C
• Transport/storage temperature	-40 to +80 °C	-40 to +80 °C	-40 to +80 °C
• Relative humidity during operation	< 95% (no condensation)	< 95% (no condensation)	< 95% (no condensation)
Design			
• Dimensions (W x H x D) in mm	120 x 125 x 124	120 x 125 x 124	120 x 125 x 124
• Weight	1400 g	1400 g	1400 g
• Mounting	DIN rail, S7-300 rail, wall mounting	DIN rail, S7-300 rail, wall mounting	DIN rail, S7-300 rail, wall mounting
Degree of protection	IP30	IP30	IP30
Approvals			
• Radio interference suppression level	EN 61000-6-4 Class A	EN 61000-6-4 Class A	EN 61000-6-4 Class A
• Noise immunity	EN 61000-6-2	EN 61000-6-2	EN 61000-6-2
• cUL-Listung	UL 60950-1, CSA C22.2 No. 60950-1; UL 508, CSA C22.2 No. 14-M91; UL 1604 and 2279 (Hazardous Location)	UL 60950-1, CSA C22.2 No. 60950-1; UL 508, CSA C22.2 No. 14-M91; UL 1604 and 2279 (Hazardous Location)	UL 60950-1, CSA C22.2 No. 60950-1; UL 508, CSA C22.2 No. 14-M91; UL 1604 and 2279 (Hazardous Location)
• FM	FM 3611	FM 3611	FM 3611
• ATEX Zone 2	EN 50021	EN 50021	EN 50021
• C-Tick	AS/NZS 2064 (Class A)	AS/NZS 2064 (Class A)	AS/NZS 2064 (Class A)
• CE	EN 61000-6-2, EN 61000-6-4	EN 61000-6-2, EN 61000-6-4	EN 61000-6-2, EN 61000-6-4

Type	SCALANCE X204 IRT	SCALANCE X202-2 IRT	SCALANCE X202-2P IRT
Transmission rate	10/100 Mbit/s	10/100 Mbit/s	10/100 Mbit/s
Interfaces			
• Communications connection, electrical (see also table "Summary of interfaces")	4 x RJ45 (10/100 Mbit/s; TP)	2 x RJ45 (10/100 Mbit/s; TP)	2 x RJ45 (10/100 Mbit/s; TP)
• Communications connection, optical (see also table "Summary of interfaces")	--	2 x BFOC socket (100 Mbit/s)	2 x SC RJ socket (100 Mbit/s)
• Connection for power supply	1 x 4-contact terminal block	1 x 4-contact terminal block	1 x 4-contact terminal block
• Connection for signaling contact	1 x 2-contact terminal block	1 x 2-contact terminal block	1 x 2-contact terminal block
• Slot for swap medium	C-PLUG	C-PLUG	C-PLUG
Power supply	2 x 24 V DC (18 to 32 V)	2 x 24 V DC (18 to 32 V)	2 x 24 V DC (18 to 32 V)
Current consumption	200 mA	300 mA	300 mA
Power loss at 24 V DC	4.8 W	7.2 W	7.2 W
Network size parameters / TP cable length			
• 0 to 50 m	--	--	POF 980/1000 with 650 nm 10 MHz x 100 m
• 0 to 55 m	IE TP Torsion Cable with IE FC RJ45 Plug	IE TP Torsion Cable with IE FC RJ45 Plug	IE TP Torsion Cable with IE FC RJ45 Plug
	IE FC Outlet RJ45 with IE TP Torsion Cable (0 to 45 m) + 10 m TP Cord	IE FC Outlet RJ45 with IE TP Torsion Cable (0 to 45 m) + 10 m TP Cord	IE FC Outlet RJ45 with IE TP Torsion Cable (0 to 45 m) + 10 m TP Cord
• 0 to 85 m	IE FC Marine/ Trailing/ Flexible/ FRNC Cable with IE FC RJ45 Plug	IE FC Marine/ Trailing/ Flexible/ FRNC Cable with IE FC RJ45 Plug	IE FC Marine/ Trailing/ Flexible/ FRNC Cable with IE FC RJ45 Plug
	IE FC Outlet RJ45 with IE FC Marine/Trailing/Flexible Cable (0 to 75 m) + 10 m TP Cord	IE FC Outlet RJ45 with IE FC Marine/Trailing/Flexible Cable (0 to 75 m) + 10 m TP Cord	IE FC Outlet RJ45 with IE FC Marine/Trailing/Flexible Cable (0 to 75 m) + 10 m TP Cord
• 0 to 100 m	--	--	PCF 200/230 with 650 nm 17 MHz x km
	IE FC Standard Cable GP with IE FC RJ45 Plug	IE FC Standard Cable GP with IE FC RJ45 Plug	IE FC Standard Cable GP with IE FC RJ45 Plug
	IE FC Outlet RJ45 with IE FC TP Standard Cable GP (0 to 90 m) + 10 m TP Cord	IE FC Outlet RJ45 with IE FC Standard Cable GP (0 to 90 m) + 10 m TP Cord	IE FC Outlet RJ45 with IE FC Standard Cable GP (0 to 90 m) + 10 m TP Cord
• 0 to 3000 m	--	Glass FOC 62.5/125 µm or 50/125µm; ≤ 1.0 dB/km with 1300 nm; ≥ 600 MHz x km	--
Permissible ambient conditions			
• Operating temperature	-20 °C to +70 °C	-10 to +60 °C	0 to +60 °C
• Transport/storage temperature	-40 °C to +80 °C	-40 to +80 °C	-40 to +80 °C
• Relative humidity during operation	< 95% (no condensation)	< 95% (no condensation)	< 95% (no condensation)
Design			
• Dimensions (W x H x D) in mm	60 x 125 x 124	60 x 125 x 124	60 x 125 x 124
• Weight	780 g	780 g	780 g
• Mounting	DIN rail, S7-300 rail, wall mounting	DIN rail, S7-300 rail, wall mounting	DIN rail, S7-300 rail, wall mounting
Degree of protection	IP30	IP30	IP30
Approvals			
• Radio interference suppression level	EN 61000-6-4 Class A	EN 61000-6-4 Class A	EN 61000-6-4 Class A
• Noise immunity	EN 61000-6-2	EN 61000-6-2	EN 61000-6-2
• cUL-Listung	UL 60950-1, CSA C22.2 No. 60950-1	UL 60950-1, CSA C22.2 No. 60950-1	UL 60950-1, CSA C22.2 No. 60950-1
• FM	FM 3611	FM 3611	FM 3611
• ATEX Zone 2	EN 50021	EN 50021	EN 50021
• C-Tick	AS/NZS 2064 (Class A)	AS/NZS 2064 (Class A)	AS/NZS 2064 (Class A)
• CE	EN 61000-6-2, EN 61000-6-4	EN 61000-6-2, EN 61000-6-4	EN 61000-6-2, EN 61000-6-4
• Shipbuilding approvals	<ul style="list-style-type: none"> American Bureau of Shipping Nippon Kaiji Kyokai Det Norske Veritas 	<ul style="list-style-type: none"> American Bureau of Shipping Nippon Kaiji Kyokai Det Norske Veritas 	<ul style="list-style-type: none"> Lloyds Register of Shipping Det Norske Veritas Germanischer Lloyd

Communication Industrial Ethernet

SCALANCE X Industrial Ethernet switches

Type	SCALANCE X201-3P IRT	SCALANCE X200-4P IRT
Transmission rate	10/100 Mbit/s	10/100 Mbit/s
Interfaces		
• Communications connection, electrical (see also table "Summary of interfaces")	1 x RJ45 (10/100 Mbit/s; TP)	--
• Communications connection, optical (see also table "Summary of interfaces")	3 x SC RJ socket (100 Mbit/s)	4 x SC RJ socket (100 Mbit/s)
• Connection for power supply	1 x 4-contact terminal block	1 x 4-contact terminal block
• Connection for signaling contact	1 x 2-contact terminal block	1 x 2-contact terminal block
• Slot for swap medium	C-PLUG	C-PLUG
Power supply	2 x 24 V DC (18 to 32 V)	2 x 24 V DC (18 to 32 V)
Current consumption	350 mA	400 mA
Power loss at 24 V DC	8.4 W	9.6 W
Network size parameters / TP cable length		
• 0 to 50 m	POF 980/1000 with 650 nm 10 MHz x 100 m	POF 980/1000 with 650 nm 10 MHz x 100 m
• 0 to 55 m	IE TP Torsion Cable with IE FC RJ45 Plug	--
	IE FC Outlet RJ45 with IE TP Torsion Cable (0 to 45 m) + 10 m TP Cord	--
• 0 to 85 m	IE FC Marine/ Trailing/ Flexible/ FRNC Cable with IE FC RJ45 Plug	--
	IE FC Outlet RJ45 with IE FC Marine/Trailing/Flexible Cable (0 to 75 m) + 10 m TP Cord	--
• 0 to 100 m	IE FC Standard Cable GP with IE FC RJ45 Plug	--
	IE FC Outlet RJ45 with IE FC Standard Cable GP (0 to 90 m) + 10 m TP Cord	--
	PCF 200/230 with 650 nm 17 MHz x km	PCF 200/230 with 650 nm 17 MHz x km
• 0 to 3000 m	--	--
Permissible ambient conditions		
• Operating temperature	0 to +50 °C	0 to +40 °C
• Transport/storage temperature	-40 to +80 °C	-40 to +80 °C
• Relative humidity during operation	< 95% (no condensation)	< 95% (no condensation)
Design		
• Dimensions (W x H x D) in mm	60 x 125 x 124	60 x 125 x 124
• Weight	780 g	780 g
• Mounting	DIN rail, S7-300 rail, wall mounting	DIN rail, S7-300 rail, wall mounting
Degree of protection	IP30	IP30
Approvals		
• Radio interference suppression level	EN 61000-6-4 Class A	EN 61000-6-4 Class A
• Noise immunity	EN 61000-6-2	EN 61000-6-2
• cUL-Listung	UL 60950-1, CSA C22.2 No. 60950-1	UL 60950-1, CSA C22.2 No. 60950-1
• FM	FM 3611	FM 3611
• ATEX Zone 2	EN 50021	EN 50021
• C-Tick	AS/NZS 2064 (Class A)	AS/NZS 2064 (Class A)
• CE	EN 61000-6-2, EN 61000-6-4	EN 61000-6-2, EN 61000-6-4
• Shipbuilding approvals	<ul style="list-style-type: none"> • Lloyds Register of Shipping • Det Norske Veritas • Germanischer Lloyd 	<ul style="list-style-type: none"> • Lloyds Register of Shipping • Det Norske Veritas • Germanischer Lloyd

Type	SCALANCE X208	SCALANCE X206-1LD	SCALANCE X204-2
Transmission rate	10/100 Mbit/s	10/100 Mbit/s	10/100 Mbit/s
Interfaces			
• Communications connection, electrical (see also table "Summary of interfaces")	8 x RJ45 (10/100 Mbit/s; TP)	6 x RJ45 (10/100 Mbit/s; TP)	4 x RJ45 (10/100 Mbit/s; TP)
• Communications connection, optical (see also table "Summary of interfaces")	--	1 x BFOC socket (100 Mbit/s)	2 x BFOC socket (100 Mbit/s)
• Connection for power supply	1 x 4-contact terminal block	1 x 4-contact terminal block	1 x 4-contact terminal block
• Connection for signaling contact	1 x 2-contact terminal block	1 x 2-contact terminal block	1 x 2-contact terminal block
• Slot for swap medium	C-PLUG	C-PLUG	C-PLUG
Power supply	2 x 24 V DC (18 to 32 V)	2 x 24 V DC (18 to 32 V)	2 x 24 V DC (18 to 32 V)
Current consumption	185 mA	200 mA	215 mA
Power loss at 24 V DC	4 W	4.8 W	5.16 W
Network size parameters / TP cable length			
• 0 to 55 m	IE TP Torsion Cable with IE FC RJ45 Plug	IE TP Torsion Cable with IE FC RJ45 Plug	IE TP Torsion Cable with IE FC RJ45 Plug
	IE FC Outlet RJ45 with IE TP Torsion Cable (0 to 45 m) + 10 m TP Cord	IE FC Outlet RJ45 with IE TP Torsion Cable (0 to 45 m) + 10 m TP Cord	IE FC Outlet RJ45 with IE TP Torsion Cable (0 to 45 m) + 10 m TP Cord
• 0 to 85 m	IE FC Marine/Trailing/Flexible/FRNC Cable with IE FC RJ45 Plug	IE FC Marine/Trailing/Flexible/FRNC Cable with IE FC RJ45 Plug	IE FC Marine/Trailing/Flexible/FRNC Cable with IE FC RJ45 Plug
	IE FC Outlet RJ45 with IE FC Marine/Trailing/Flexible Cable (0 to 75 m) + 10 m TP Cord	IE FC Outlet RJ45 with IE FC Marine/Trailing/Flexible Cable (0 to 75 m) + 10 m TP Cord	IE FC Outlet RJ45 with IE FC Marine/Trailing/Flexible Cable (0 to 75 m) + 10 m TP Cord
• 0 to 100 m	IE FC Standard Cable GP with IE FC RJ45 Plug	IE FC Standard Cable GP with IE FC RJ45 Plug	IE FC Standard Cable GP with IE FC RJ45 Plug
	IE FC Outlet RJ45 with IE FC Standard Cable (0 to 90 m) + 10 m TP Cord	IE FC Outlet RJ45 with IE FC Standard Cable GP (0 to 90 m) + 10 m TP Cord	IE FC Outlet RJ45 with IE FC Standard Cable GP (0 to 90 m) + 10 m TP Cord
• 0 to 3 km	--	--	Glass FOC 62.5/125 µm or 50/125 µm; ≤ 1.0 dB/km with 1300 nm; ≥ 600 MHz x km
• 0 to 26 km	--	Glass FOC or 9/125 µm single-mode fiber; 0.5 dB/km with 1300 nm	--
Permissible ambient conditions			
• Operating temperature	-20 to +70 °C	0 to +60 °C	-10 to +60 °C
• Transport/storage temperature	-40 to +80 °C	-40 to +80 °C	-40 to +80 °C
• Relative humidity during operation	< 95% (no condensation)	< 95% (no condensation)	< 95% (no condensation)
Design			
• Dimensions (W x H x D) in mm	60 x 125 x 124	60 x 125 x 124	60 x 125 x 124
• Weight	780 g	780 g	780 g
• Mounting	DIN rail, S7-300 rail, wall mounting	DIN rail, S7-300 rail, wall mounting	DIN rail, S7-300 rail, wall mounting
Degree of protection	IP30	IP30	IP30
Approvals			
• Radio interference suppression level	EN 61000-6-4 Class A	EN 61000-6-4 Class A	EN 61000-6-4 Class A
• Noise immunity	EN 61000-6-2	EN 61000-6-2	EN 61000-6-2
• cUL-Listung	UL 60950-1, CSA C22.2 No. 60950-1	UL 60950-1, CSA C22.2 No. 60950-1	UL 60950-1, CSA C22.2 No. 60950-1
• FM	FM 3611	FM 3611	FM 3611
• ATEX Zone 2	EN 50021	EN 50021	EN 50021
• C-Tick	AS/NZS 2064 (Class A)	AS/NZS 2064 (Class A)	AS/NZS 2064 (Class A)
• CE	EN 61000-6-2, EN 61000-6-4	EN 61000-6-2, EN 61000-6-4	EN 61000-6-2, EN 61000-6-4
• Shipbuilding approvals	<ul style="list-style-type: none"> • Lloyds Register of Shipping • Det Norske Veritas • Germanischer Lloyd • Nippon Kaiji Kyokai • American Bureau of Shipping • Bureau Veritas 	<ul style="list-style-type: none"> • Lloyds Register of Shipping • Det Norske Veritas • Germanischer Lloyd • Nippon Kaiji Kyokai • Bureau Veritas 	<ul style="list-style-type: none"> • Lloyds Register of Shipping • Det Norske Veritas • Germanischer Lloyd • Nippon Kaiji Kyokai • Bureau Veritas

Communication Industrial Ethernet

SCALANCE X Industrial Ethernet switches

Type	SCALANCE X212-2	SCALANCE X212-2LD
Transmission rate	10/100 Mbit/s	10/100 Mbit/s
Interfaces		
• Communications connection, electrical (see also table "Summary of interfaces")	12 x RJ45 (10/100 Mbit/s; TP)	12 x RJ45 (10/100 Mbit/s; TP)
• Communications connection, optical (see also table "Summary of interfaces")	2 x BFOC socket (100 Mbit/s)	2 x BFOC socket (100 Mbit/s)
• Connection for power supply	1 x 4-contact terminal block	1 x 4-contact terminal block
• Connection for signaling contact	1 x 2-contact terminal block	1 x 2-contact terminal block
• Slot for swap medium	C-PLUG	C-PLUG
Power supply	2 x 24 V DC (18 to 32 V)	2 x 24 V DC (18 to 32 V)
Current consumption	330 mA	330 mA
Power loss at 24 V DC	7.92 W	7.92 W
Network size parameters / TP cable length		
• 0 to 55 m	IE TP Torsion Cable with IE FC RJ45 Plug IE FC Outlet RJ45 with IE TP Torsion Cable (0 to 45 m) + 10 m TP Cord	IE TP Torsion Cable with IE FC RJ45 Plug IE FC Outlet RJ45 with IE TP Torsion Cable (0 to 45 m) + 10 m TP Cord
• 0 to 85 m	IE FC Marine/ Trailing/ Flexible/ FRNC Cable with IE FC RJ45 Plug IE FC Outlet RJ45 with IE FC Marine/ Trailing/Flexible Cable (0 to 75 m) + 10 m TP Cord	IE FC Marine/ Trailing/ Flexible/ FRNC Cable with IE FC RJ45 Plug IE FC Outlet RJ45 with IE FC Marine/ Trailing/Flexible Cable (0 to 75 m) + 10 m TP Cord
• 0 to 100 m	IE FC Standard Cable GP with IE FC RJ45 Plug IE FC Outlet RJ45 with IE FC Standard Cable GP (0 to 90 m) + 10 m TP Cord	IE FC Standard Cable GP with IE FC RJ45 Plug IE FC Outlet RJ45 with IE FC Standard Cable GP (0 to 90 m) + 10 m TP Cord
• 0 to 750 m	Glass FOC 62.5/125 µm or 50/125 µm; ≤ 1.0 dB/km with 1300 nm; ≥ 600 MHz x km	--
• 0 to 3 km	--	Glass FOC or 9/125 µm singlemode fiber; 0.5 dB/km with 1300 nm
• 0 to 26 km	IE TP Torsion Cable with IE FC RJ45 Plug	IE TP Torsion Cable with IE FC RJ45 Plug
Permissible ambient conditions		
• Operating temperature	0 to +60 °C	0 to +60 °C
• Transport/storage temperature	-40 to +80 °C	-40 to +80 °C
• Relative humidity during operation	< 95% (no condensation)	< 95% (no condensation)
Design		
• Dimensions (W x H x D) in mm	120 x 125 x 124	120 x 125 x 124
• Weight	1200 g	1200 g
• Mounting	DIN rail, S7-300 rail, wall mounting	DIN rail, S7-300 rail, wall mounting
Degree of protection	IP30	IP30
Approvals		
• Radio interference suppression level	EN 61000-6-4 Class A	EN 61000-6-4 Class A
• Noise immunity	EN 61000-6-2	EN 61000-6-2
• cUL-Listung	UL 60950-1, CSA C22.2 No. 60950-1	UL 60950-1, CSA C22.2 No. 60950-1
• FM	FM 3611	FM 3611
• ATEX Zone 2	EN 50021	EN 50021
• C-Tick	AS/NZS 2064 (Class A)	AS/NZS 2064 (Class A)
• CE	EN 61000-6-2, EN 61000-6-4	EN 61000-6-2, EN 61000-6-4
• Shipbuilding approvals	<ul style="list-style-type: none"> • Lloyds Register of Shipping • Det Norske Veritas • Germanischer Lloyd • Nippon Kaiji Kyokai • Bureau Veritas 	<ul style="list-style-type: none"> • Lloyds Register of Shipping • Det Norske Veritas • Germanischer Lloyd • Nippon Kaiji Kyokai • Bureau Veritas

Type	SCALANCE X216	SCALANCE X224
Transmission rate	10/100 Mbit/s	10/100 Mbit/s
Interfaces		
• Communications connection, electrical (see also table "Summary of interfaces")	16 x RJ45 (10/100 Mbit/s; TP)	24 x RJ45 (10/100 Mbit/s; TP)
• Communications connection, optical (see also table "Summary of interfaces")	--	--
• Connection for power supply	1 x 4-contact terminal block	1 x 4-contact terminal block
• Connection for signaling contact	1 x 2-contact terminal block	1 x 2-contact terminal block
• Slot for swap medium	C-PLUG	C-PLUG
Power supply	2 x 24 V DC (18 to 32 V)	2 x 24 V DC (18 to 32 V)
Current consumption	240 mA	350 mA
Power loss at 24 V DC	5.76 W	8.4 W
Network size parameters / TP cable length		
• 0 to 55 m	IE TP Torsion Cable with IE FC RJ45 Plug	IE TP Torsion Cable with IE FC RJ45 Plug
	IE FC Outlet RJ45 with IE TP Torsion Cable (0 to 45 m) + 10 m TP Cord	IE FC Outlet RJ45 with IE TP Torsion Cable (0 to 45 m) + 10 m TP Cord
• 0 to 85 m	IE FC Marine/ Trailing/ Flexible/ FRNC Cable with IE FC RJ45 Plug	IE FC Marine/ Trailing/ Flexible/ FRNC Cable with IE FC RJ45 Plug
	IE FC Outlet RJ45 with IE FC Marine/Trailing/ Flexible Cable (0 to 75 m) + 10 m TP Cord	IE FC Outlet RJ45 with IE FC Marine/Trailing/ Flexible Cable (0 to 75 m) + 10 m TP Cord
• 0 to 100 m	IE FC Standard Cable GP with IE FC RJ45 Plug	IE FC Standard Cable GP with IE FC RJ45 Plug
	IE FC Outlet RJ45 with IE FC Standard Cable GP (0 to 90 m) + 10 m TP Cord	IE FC Outlet RJ45 with IE FC Standard Cable GP (0 to 90 m) + 10 m TP Cord
Permissible ambient conditions		
• Operating temperature	0 to +60 °C	0 to +60 °C
• Transport/storage temperature	-40 to +80 °C	-40 to +80 °C
• Relative humidity during operation	< 95% (no condensation)	< 95% (no condensation)
Design		
• Dimensions (W x H x D) in mm	120 x 125 x 124	120 x 125 x 124
• Weight	1200 g	1200 g
• Mounting	DIN rail, S7-300 rail, wall mounting	DIN rail, S7-300 rail, wall mounting
Degree of protection	IP30	IP30
Approvals		
• Radio interference suppression level	EN 61000-6-4 Class A	EN 61000-6-4 Class A
• Noise immunity	EN 61000-6-2	EN 61000-6-2
• cUL-Listung	UL 60950-1, CSA C22.2 No. 60950-1	UL 60950-1, CSA C22.2 No. 60950-1
• FM	FM 3611	FM 3611
• ATEX Zone 2	EN 50021	EN 50021
• C-Tick	AS/NZS 2064 (Class A)	AS/NZS 2064 (Class A)
• CE	EN 61000-6-2, EN 61000-6-4	EN 61000-6-2, EN 61000-6-4
• Shipbuilding approvals	<ul style="list-style-type: none"> • Lloyds Register of Shipping • Det Norske Veritas • Germanischer Lloyd • Nippon Kaiji Kyokai • American Bureau of Shipping • Bureau Veritas 	<ul style="list-style-type: none"> • Lloyds Register of Shipping • Det Norske Veritas • Germanischer Lloyd • Nippon Kaiji Kyokai • American Bureau of Shipping • Bureau Veritas

Communication

Industrial Ethernet

SCALANCE X Industrial Ethernet switches

Selection and Ordering Data Order No.

Industrial Ethernet switches, transmission rate 10/100/1000 Mbit/s for electrical and/or optical Industrial Ethernet networks, especially for Fast Ethernet and Gigabit rings

SCALANCE X-400 Industrial Ethernet switches

- SCALANCE X414-3E
2 x 10/100/1000 Mbit/s and
12 x 10/100 Mbit/s RJ45 ports;
1 x Gigabit Ethernet and
2 x Fast Ethernet media module
slots;
1 x Extender interface
- SCALANCE X408-2
4 x 10/100/1000 Mbit/s and
4 x 10/100 Mbit/s RJ45 ports;
2 x Gigabit/Fast Ethernet media
module slots

6GK5 414-3FC00-2AA2

6GK5 408-2FD00-2AA2

MM491/MM492 media modules

Media modules with 2 ports;
1 Gbit/s, SC connection

- MM492-2 media module
1000BaseSX, multi-mode
FO cable up to 750 m
- MM492-2LD media module
1000BaseLX, single-mode
FO cable up to 10 km
- MM492-2LH media module
1000BaseLX, single-mode
FO cable up to 40 km
- MM492-2LH+ media module
1000BaseLX, single-mode
FO cable up to 70 km

6GK5 492-2AL00-8AA2 B)

6GK5 492-2AM00-8AA2 E)

6GK5 492-2AN00-8AA2

6GK5 492-2AP00-8AA2

Media modules with 2 ports;
100 Mbit/s, BFOC connection
(ST sockets)

- MM491-2 media module
100BaseFX, multi-mode FO
cable up to 3 km
- MM491-2LD media module
100BaseFX long distance, sin-
gle-mode FO cable up to 26 km

6GK5 491-2AB00-8AA2

6GK5 491-2AC00-8AA2

EM495/EM496 extender mod- ules for SCALANCE X414-3E

- EM495-8 extender module
with 8 x 10/100 Mbit/s TP ports
- EM496-4 extender module
with 4 slots for 100 Mbit/s media
modules

6GK5 495-8BA00-8AA2

6GK5 496-4MA00-8AA2

Industrial Ethernet switches, transmission rate 10/100 Mbit/s for Industrial Ethernet line, star or ring topologies

SCALANCE X-300 Industrial Ethernet switches

- SCALANCE X310
3 x 10/100/1000 Mbit/s RJ45
ports
7 x 10/100 Mbit/s RJ45 ports
- SCALANCE X308-2
2 x 1000 Mbit/s multimode SC
ports (1000BaseSX)
1 x 10/100/1000 Mbit/s RJ45
port
7 x 10/100 Mbit/s RJ45 ports
- SCALANCE X308-2LD
2 x 1000 Mbit/s singlemode SC
ports (1000BaseFX)
1 x 10/100/1000 Mbit/s RJ45
port
7 x 10/100 Mbit/s RJ45 ports

6GK5 310-0FA00-2AA3

6GK5 308-2FL00-2AA3

6GK5 308-2FM00-2AA3

Selection and Ordering Data Order No.

SCALANCE X-200 IRT Industrial Ethernet switches

- SCALANCE X204 IRT
4 x 10/100 Mbit/s RJ45 ports
- SCALANCE X202-2 IRT
2 x 10/100 Mbit/s RJ45 ports,
2 x 100 Mbit/s multi-mode BFOC
ports (100BaseFX)
- SCALANCE X202-2P IRT
2 x 10/100 Mbit/s RJ45 ports,
2 x 100 Mbit/s POF/PCF SC RJ
ports
- SCALANCE X201-3P IRT
1 x 10/100 Mbit/s RJ45 port,
3 x 100 Mbit/s POF/PCF SC RJ
ports
- SCALANCE X200-4P IRT
4 x 100 Mbit/s POF/PCF SC RJ

6GK5 204-0BA00-2BA3

6GK5 202-2BB00-2BA3

6GK5 202-2BH00-2BA3

6GK5 201-3BH00-2BA3

6GK5 200-4AH00-2BA3

SCALANCE X-200 Industrial Ethernet switches with electrical ports and optical ports for glass multimode FO cable up to 3 km

- SCALANCE X204-2
4 x 10/100 Mbit/s RJ45 ports
2 x 100 Mbit/s multi-mode BFOC
ports (100BaseFX)
- SCALANCE X212-2
12 x 10/100 Mbit/s RJ45 ports
2 x 100 Mbit/s multi-mode BFOC
ports (100BaseFX)

6GK5 204-2BB10-2AA3

6GK5 212-2BB00-2AA3

SCALANCE X-200 Industrial Ethernet switches with electrical ports and optical ports for glass singlemode FO cable up to 26 km

- SCALANCE X206-1LD
6 x 10/100 Mbit/s RJ45 ports
1 x 100 Mbit/s singlemode
BFOC ports (100BaseFX)
- SCALANCE X212-2LD
12 x 10/100 Mbit/s RJ45 ports
2 x 100 Mbit/s singlemode
BFOC ports (100BaseFX)

6GK5 206-1BC10-2AA3

6GK5 212-2BC00-2AA3

SCALANCE X-200 Industrial Ethernet switches with electrical ports

- SCALANCE X208
8 x 10/100 Mbit/s RJ45 ports
- SCALANCE X216
16 x 10/100 Mbit/s RJ45 ports
- SCALANCE X224
24 x 10/100 Mbit/s RJ45 ports

6GK5 208-0BA10-2AA3 E)

6GK5 216-0BA00-2AA3

6GK5 224-0BA00-2AA3

Accessory for Industrial Ethernet switches

C-PLUG

Swap medium for simple replacement of devices in event of fault; for saving of configuration and application data, can be used in SIMATIC NET products with C-PLUG slot

6GK1 900-0AB00 B)

B) Subject to export regulations: AL: N, ECCN: EAR99H
E) Subject to export regulations: AL: N, ECCN: 5A991

Note:

For further components and accessories, especially cable material and connectors as well as tools and supplementary material for assembly, refer to page 9/23, 9/25 and 9/26 as well as to Catalog IK PI.

OSM/ESM/OMC Industrial Ethernet switches

Overview



The Industrial Ethernet OSM and ESM switches are used to construct Industrial Ethernet networks at the control level:

- The modules are interconnected (backbone) at 100 Mbit/s over
 - Glass fiber-optic cables (FO) for OSM
 - Twisted pair cables for ESM
- Connection of data terminals or network segments depending on the OSM/ESM type through
 - 2 to 8 twisted pair ports 10/100BaseTX in RJ45 or 9-pole Sub-D design for 10/100 Mbit/s
 - 3 or 8 FO ports 100BaseFX with BFOC interface (ST socket) for 100 Mbit/s
- Integral redundancy manager supports high-speed media redundancy also for large networks
- Very easy network configuration and extension without complex configuration rules or parameterization

Application

Industrial Ethernet OSM and ESM

The Industrial Ethernet OSM (Optical Switch Module) and ESM (Electrical Switch Module) are used in the construction of switched networks with data transmission rates of 100 Mbit/s in the control level range, in which strict demands are placed on network availability and comprehensive diagnostics are required.

In existing networks, load decoupling and thus increased network performance can be achieved by creating segments (dividing a network into subnetworks/segments) and connecting these segments to an OSM/ESM.

The redundancy manager integrated into OSM/ESM allows Industrial Ethernet rings to be constructed in switching technology with high-speed switching over of the communication path on failure of a switch or interruption in the transmission path (reconfiguration time max. 0.3 seconds).

The transmission rate in the ring is 100 Mbit/s; for each ring, up to 50 Industrial Ethernet OSMs (optical ring) or ESMs (electrical ring) can be used. Apart from the 2 ring ports, OSM/ESM has other ports (with either RJ45, ITP or BFOC interfaces) to which data terminals or network segments can be connected.

Selection support for the various product versions of OSM is provided by the table under "Technical specifications".

Industrial Ethernet media converter

Industrial Ethernet nodes with RJ45 TP interface can be connected via an Industrial Ethernet media converter to one of the 8 optical ports of an OSM BC08. The two types of media converter SCALANCE X101-1 or X101-1LD convert the electric twisted-pair interface, port type 10/100BaseTX (10/100 Mbit/s, RJ45 socket) as follows:

- X101-1: into an optical interface for **multimode** glass FOC
- X101-1LD: into an optical interface for **singlemode** glass FOC

The port type of the optical interface is 100BaseFX in each case (100 Mbit/s; 2 x BFOC socket).

Notes:

Just like the OMC TP11 media converter, the SCALANCE X101-1 does not support diagnostics per SNMP protocol.

For further information on the Industrial Ethernet media converter, see Catalog IK PI, Section "Active network components - Industrial Ethernet media converter".

Technical specifications

Selection support for product versions of OSM and ESM

	Type and number of ports				Preferentially for use		
	RJ45 (TP)	Sub-D (ITP)	Multi-mode FO	Single-mode FO	With high EMC loading	For plant bus	For terminal bus (OS-LAN)
OSM TP22	2	–	2	–	● ¹⁾	●	●
OSM ITP62 (Standard)	–	6	2	–	●	●	●
OSM TP62	6	–	2	–	●	●	●
OSM ITP62-LD	–	6	–	2	●	●	●
OSM ITP53	–	5	3	–	●	● ²⁾	● ²⁾
OSM BC08	–	–	8	–	● ³⁾	● ³⁾	● ³⁾
SCALANCE X101-1	1	–	1	–	● ⁴⁾	● ⁴⁾	● ⁴⁾
SCALANCE X101-1LD	1	–	–	1	● ⁴⁾	● ⁴⁾	● ⁴⁾
ESM ITP80	–	8	–	–	●	● ⁵⁾	●
ESM TP40	4	–	–	–	●	● ⁶⁾	●
ESM TP80	8	–	–	–	●	● ⁶⁾	●

- 1) TP cable preferably inside a control cabinet
- 2) For cross-building connection of Fast Ethernet networks with OSM
- 3) For design of an optical network, where TP cables are preferably only used inside control cabinets
- 4) Connects a station with RJ45-TP interface to one of the 8 optical ports of an OSM BC08
- 5) Inside buildings
- 6) Inside switchrooms

Communication

Industrial Ethernet

OSM/ESM/OMC Industrial Ethernet switches

Selection and Ordering Data

Order No.

Industrial Ethernet OSM TP22

Optical switch module with 2 fiber optic ports 100 Mbit/s, 2 RJ45 ports 10/100 Mbit/s and 4 digital inputs; redundant 24 V DC supply and signal contact; with network management

6GK1 105-2AE00

Industrial Ethernet OSM ITP62

Optical switch module with 2 fiber optic ports 100 Mbit/s, 6 ITP ports 10/100 Mbit/s and 8 digital inputs; redundant 24 V DC supply and signal contact; with network management

6GK1 105-2AA10

Industrial Ethernet OSM TP62

Optical switch module with 2 fiber optic ports 100 Mbit/s, 6 RJ45 ports 10/100 Mbit/s and 8 digital inputs; redundant 24 V DC supply and signal contact; with network management

6GK1 105-2AB10

Industrial Ethernet OSM ITP62-LD

Optical switch module with 2 fiber optic ports 100 Mbit/s long distance (single-mode fiber optic cable up to 26 km), 6 ITP ports 10/100 Mbit/s and 8 digital inputs; redundant 24 V DC supply and signal contact; with network management

6GK1 105-2AC10

Industrial Ethernet OSM ITP53

Optical switch module with 3 fiber optic ports 100 Mbit/s, 5 ITP ports 10/100 Mbit/s and 8 digital inputs; redundant 24 V DC supply and signal contact; with network management, for cross-building connection of two Fast Ethernet networks with OSM

6GK1 105-2AD10

Selection and Ordering Data

Order No.

Industrial Ethernet ESM TP40

Electrical switch module with 4 RJ45 ports 10/100 Mbit/s and 4 digital inputs; redundant 24 V DC supply and signal contact; with network management, preferably for OS-LAN

6GK1 105-3AC00

Industrial Ethernet ESM ITP80

Electrical switch module with 8 ITP ports 10/100 Mbit/s and 8 digital inputs; redundant 24 V DC supply and signal contact; with network management, preferably for OS-LAN

6GK1 105-3AA10

Industrial Ethernet ESM TP80

Electrical switch module with 8 RJ45 ports 10/100 Mbit/s and 8 digital inputs; redundant 24 V DC supply and signal contact; with network management, preferably for OS-LAN

6GK1 105-3AB10

Industrial Ethernet OSM BC08

Optical switch module with 8 fiber optic ports 100 Mbit/s and 8 digital inputs; redundant 24 V DC supply and signal contact; with network management

6GK1 105-4AA00

SCALANCE X101-1 Industrial Ethernet media converter

For conversion from RJ45 TP to multimode fiber optic cable (BFOC) with 100 Mbit/s; 1 x 10/100 Mbit/s RJ45 Port and 1 x 100 Mbit/s multimode BFOC; redundant 24 V supply and signal contact

6GK5 101-1BB00-2AA3 E)

SCALANCE X101-1LD Industrial Ethernet media converter

For conversion from RJ45 TP to singlemode fiber optic cable (BFOC) with 100 Mbit/s; 1 x 10/100 Mbit/s RJ45 Port and 1 x 100 Mbit/s singlemode BFOC; redundant 24 V supply and signal contact

6GK5 101-1BC00-2AA3 E)

E) Subject to export regulations: AL: N, ECCN: 5A991

Passive network components: FastConnect

Overview

Industrial Ethernet FastConnect (IE FC) is a fast assembly system with insulation displacement for easy assembly and wiring of 4-core and 8-core IE FC cables. Using the FC Stripping Tool it is possible to remove the outer casing and the woven shield of the IE FC cable accurately in a single step. The cable prepared in this manner is subsequently assembled on the contacts of the connection element.

Application

Connection elements

The connection elements which can be used depend on whether the transmission rate is 10/100 Mbit/s or 1000 Mbit/s:

- IE FC RJ45 Plug 90/180 (10/100 Mbit/s) in association with 4-core (2 x 2) IE FC cables
- IE FC Outlet RJ45 (10/100 Mbit/s) in association with 4-core (2 x 2) IE FC cables
- IE FC RJ45 Modular Outlet (10/100/1000 Mbit/s) with 8-core (4 x 2) IE FC cables

The following table provides an overview of the available switches, the transmission rates they support, and the IE FC standard cables and IE FC connection elements which can be used. In addition to the IE FC standard cables, Catalog IK PI offers further IE FC cables with special properties.

Switches	X414-3E, X408-2, X310, X308-2, X308-2LD, X204 IRT, X202-2 IRT, X202-2P IRT, X201-3P IRT, X224, X216, X212-2, X212-2LD, X208, X206-1LD, X204-2, ESM	X414-3E, X408-2	
Port type	10/100BaseTX	1000BaseTX	
Transmission rate	10/100 Mbit/s	1.000 Mbit/s	
Max. cable length	100 m	100 m	
Cable type	IE FC Standard Cable 2 x 2	IE FC Standard Cable 4 x 2	IE FC Standard Cable 4 x 2
Connection elements	IE FC RJ45 Plug 90/180, alternative: IE FC Outlet RJ45 + TP Cord	IE FC RJ45 Modular Outlet with insert 2FE + TP Cord	IE FC RJ45 Modular Outlet with insert 1GE + TP Cord

IE FC RJ45 Plugs

The IE FC RJ45 Plugs are the ideal solution for communication links with a transmission rate up to 100 Mbit/s. They permit simple, fast and direct assembly of the 4-core (2 x 2) twisted pair (TP) FastConnect installation cables in the field (without patch technology) up to a cable length of 100 m. Since the IE FC RJ45 Plugs have no parts which can be lost, assembly is also possible under difficult conditions.

IE FC Outlet RJ45 and IE FC RJ45 Modular Outlet

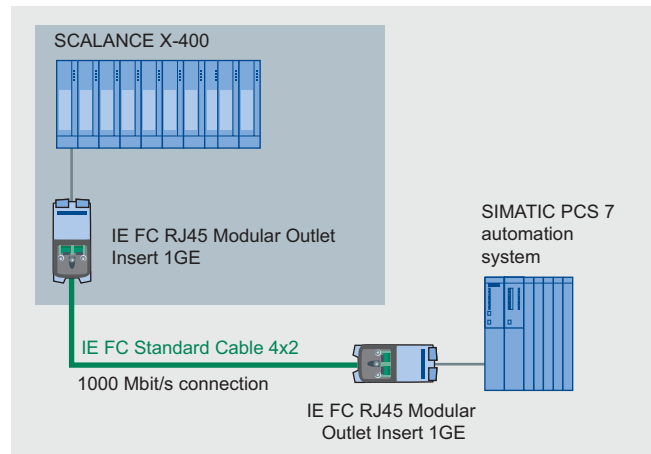

Alternatives for conversion from RJ45 to the insulation displacement system are the

- IE FC Outlet RJ45 for 4-core TP (2 x 2) IE FC cables and transmission rates up to 100 Mbit/s and
- IE FC RJ45 Modular Outlet for 8-core TP (4 x 2) IE FC cables and transmission rates up to 1000 Mbit/s.

The latter has the advantage that the existing wiring can still be used if the communication is converted from 100 Mbit/s to 1000 Mbit/s. It is only necessary to replace the 2FE insert by one of type 1GE. In contrast to the plugs, an RJ45 patch cable (TP Cord) is additionally required for each outlet which connects this to the network components or data terminal.

Detailed information on the FastConnect Outlets and the available TP Cords can be found in Catalog IK PI, Section "Industrial Ethernet", and in the A&D Mall, or in CA 01 under "Communication/networks / SIMATIC NET communication systems".

Further information on network structures is provided in the manual for TP and fiber-optic networks.

Design



IE FC RJ45 plug with 90° outgoing cable (left) and with 180° outgoing cable (right)

Communication

Industrial Ethernet

Passive network components: FastConnect

Industrial Ethernet FastConnect RJ45 Plugs are available in two versions:

- with 180° (straight) outgoing cable,
- with 90° (angled) cable outlet.

They are used for optimized connection of Industrial Ethernet FastConnect cables to data terminals and network components. The plugs have a rugged, industry-compatible metal housing that provides optimum protection against faults in data communication. The 4 integral insulation displacement contacts permit simple, fault-free contacting of the various types of FC cable. Following introduction of the stripped ends of the cables into the tipped-up barrel contacts, the latter are pressed down for secure contacting of the conductors.

The IE FC RJ45 Modular Outlet (Base Module) designed for transmission rates up to 1,000 Mbit/s consists of a rugged metal housing with IP40 degree of protection which is suitable for both DIN rail and wall mounting. It has 8 barrel contacts for connecting 8-core Industrial Ethernet FC installation cables and an interface for the replaceable insert, e.g.:

- IE FC RJ45 Modular Outlet Insert 2FE with 2 x RJ45 sockets for 100 Mbit/s
- IE FC RJ45 Modular Outlet Insert 1GE with 1 x RJ45 socket for 1,000 Mbit/s

Selection and Ordering Data

Order No.

Industrial Ethernet

FC Standard Cable GP 2 x 2

For universal use, for connection to IE FC Outlet RJ45 or IE FC RJ45, 4-core (2 x 2), shielded

- Cut-to-length; max. delivery length 1,000 m, minimum ordering length 20 m
- Preferred length 1,000 m

6XV1 840-2AH10

6XV1 840-2AU10

Industrial Ethernet

FC Standard Cable GP 4 x 2

For universal use, for connection to IE FC Modular Outlet RJ45, 8-core (4 x 2), shielded

- Cut-to-length; max. delivery length 1,000 m, minimum ordering length 20 m

6XV1 870-2E

Industrial Ethernet

FC Stripping Tool

Preadjusted stripping tool for fast stripping of Industrial Ethernet FC cables

6GK1 901-1GA00

Industrial Ethernet FC Blade Cassettes

Spare blade cassettes for the FC stripping tool, 5 cassettes

6GK1 901-1GB00

Selection and Ordering Data

Order No.

IE FC RJ45 Plug 180

RJ45 plug connector for Industrial Ethernet with a rugged metal housing and integrated insulation displacement contacts for connecting Industrial Ethernet FC installation cables; with 180° cable outlet; for network components and CPs/CPU's with Industrial Ethernet interface

- 1 pack = 1 unit
- 1 pack = 10 units
- 1 pack = 50 units

6GK1 901-1BB10-2AA0

6GK1 901-1BB10-2AB0

6GK1 901-1BB10-2AE0

Industrial Ethernet FC RJ45 Plug 90

RJ45 plug connector for Industrial Ethernet with a rugged metal housing and integrated insulation displacement contacts for connecting Industrial Ethernet FC installation cables; with 90° cable outlet

- 1 pack = 1 unit
- 1 pack = 10 units
- 1 pack = 50 units

6GK1 901-1BB20-2AA0

6GK1 901-1BB20-2AB0

6GK1 901-1BB20-2AE0

Industrial Ethernet FC Outlet RJ45

6GK1 901-1FC00-0AA0

IE FC RJ45 Modular Outlet with Insert 1GE

FastConnect RJ45 Outlet for Industrial Ethernet with a replaceable insert for 1 x 1,000 Mbit/s interface

6GK1 901-1BE00-0AA2

IE FC RJ45 Modular Outlet with Insert 2FE

FastConnect RJ45 Outlet for Industrial Ethernet with a replaceable insert for 2 x 100 Mbit/s interface

6GK1 901-1BE00-0AA1

For further IE FC RJ45 Modular Outlet versions and replaceable inserts, see Catalog IK PI

Documentation

Manual for TP and fiber-optic networks

Network architecture, components, configurations, installation

- German
- English

6GK1 970-1BA10-0AA0

6GK1 970-1BA10-0AA1

Overview

Electrical transmission media

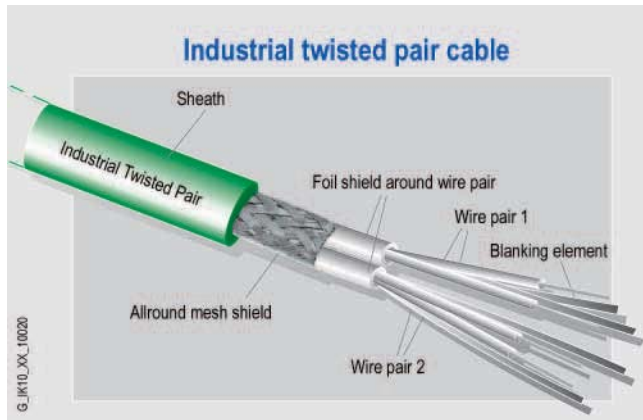

Terminals can be connected through industrial twisted pairs (ITPs). The preassembled *ITP standard cable* with Sub-D connectors is available for connection between stations and network components. Line lengths of up to 100 m can be achieved while saving on patch technology.

The *ITP standard cable 9/15* is equipped with a 9-pin and a 15-pin connector. The cable is used for direct connection of terminals with ITP interface to Industrial Ethernet components with ITP interface.

The *ITP XP standard cable 9/9* is equipped with two 9-pin connectors. This cable is crossed for direct connection of two Industrial Ethernet network components with ITP interface.

The *ITP XP standard cable 15/15* is equipped with two 15-pin connectors. This cable is crossed for direct connection of two terminals with ITP interface.

The Industrial Ethernet *ITP connectors* have Sub-D connectors made of metal and are available in two versions:

- 9-pin plug with straight cable outlet, for connection to OSM/ESM, OLM or ELM
- 15-pin plug with variable cable outlet, for connection to terminals with ITP interface

Alternatively, the terminals can also be connected to twisted pair (TP cord) cables. Detailed information on TP cord cables can be found in the IK PI catalog, in the A&D Mall or in CA 01 at "Communication/Networks / SIMATIC NET communication systems".

Selection and Ordering Data

Order No.

ITP Standard Cable for Industrial Ethernet

Not preassembled, cut-to-length

2 x 2-core, without connectors

For connection of a terminal; for self-assembly of connectors or for the connection between patch panel and socket

6XV1 850-0AH10

ITP Standard Cable 9/15

ITP installation cable for direct connection of terminals with ITP interface to Industrial Ethernet network components with ITP interface; with a 9-pin and a 15-pin Sub-D plug

- 2 m
- 5 m
- 8 m
- 12 m
- 15 m
- 20 m
- 30 m
- 40 m
- 50 m
- 60 m
- 70 m
- 80 m
- 90 m
- 100 m

6XV1 850-0BH20

6XV1 850-0BH50

6XV1 850-0BH80

6XV1 850-0BN12

6XV1 850-0BN15

6XV1 850-0BN20

6XV1 850-0BN30

6XV1 850-0BN40

6XV1 850-0BN50

6XV1 850-0BN60

6XV1 850-0BN70

6XV1 850-0BN80

6XV1 850-0BN88

6XV1 850-0BT10

ITP XP Standard Cable 9/9

Crossed ITP installation cable for direct connection of two Industrial Ethernet network components with ITP interface; with two 9-pin Sub-D plugs

- 2 m
- 5 m
- 8 m
- 12 m
- 15 m
- 20 m
- 30 m
- 40 m

6XV1 850-0CH20

6XV1 850-0CH50

6XV1 850-0CH80

6XV1 850-0CN12

6XV1 850-0CN15

6XV1 850-0CN20

6XV1 850-0CN30

6XV1 850-0CN40

ITP XP Standard Cable 15/15

Crossed ITP installation cable for direct connection of two terminals with ITP interface; with two 15-pin sub-D plugs

- 2 m
- 6 m
- 10 m

6XV1 850-0DH20

6XV1 850-0DH60

6XV1 850-0DN10

ITP Connector for Industrial Ethernet

- 9-pin, for connection to OSM/ESM, OLM or ELM
- 15-pin, for connection to terminals with ITP interface

6GK1 901-0CA00-0AA0

6GK1 901-0CA01-0AA0

Communication

Industrial Ethernet

Passive network components: Fiber-optic cables

Overview

Optical transmission media

Glass fiber-optic cables are preferably used as the optical transmission medium. The two types of cable offered are suitable for above-ground routing indoors or outdoors. They are available in fixed lengths, precut/preassembled with 2 x 2 BFOC connectors (FIBER OPTIC standard cable) or 2 x 2 SC-connectors (FO Standard Cable).

The FO Standard Cable with 2 x 2 SC connectors is required for optical networks in the Gigabit range, e.g. for implementing optical Gigabit Ethernet rings with SCALANCE X414-3E and MM492-2 media modules.

Technical specifications

Switches	X414-3E + MM492-2, X408-2 + MM492-2	X414-3E + MM491-2, X408-2 + MM491-2, X212-2, X212-2LD, X202-2 IRT, X206-1LD, X204-2, OSM
Port type	1000BaseSX	100BaseFX
Transmission rate	1000 Mbit/s	10/100 Mbit/s
Max. cable length	750 m	3000 m
Cable type	FO Standard Cable	Fiber optic standard cable
FO multimode fiber type	50/125 µm	62.5/125 µm
Connector type	2 x 2 SC	2 x 2 BFOC (ST)

Cable type	FO Standard Cable	FIBER OPTIC Standard Cable
Applications	Universal cable for installation indoors and outdoors	
Delivery format	Cut-to-length, pre-assembled with 4 BFOC(ST) or 4 SC connectors	Cut-to-length, pre-assembled with 4 BFOC connectors (ST)
Cable type (standard designation)	AT-W(ZN)YY 2x1G50/125	AT-VYY 2G62.5/125 3.1B200 + 0.8F600 F
Fiber type	Multimode gradient fiber 50/125 mm	Multimode gradient fiber 62.5/125 mm
Damping		
• At 850 nm	≤ 2.7 dB/km	≤ 3.1 dB/km
• At 1300 nm	≤ 0.7 dB/km	≤ 0.8 dB/km
Modal bandwidth		
• At 850 nm	≥ 600 MHz × km	≥ 200 MHz × km
• At 1300 nm	≥ 1200 MHz × km	≥ 600 MHz × km
Number of fibers	2	2
Cable design	Segmentable	Segmentable outer conductor
Core type	Hollow core, filled	Compact core
Materials		
• Basic element	PVC, orange/black	PVC, gray
• Strain relief	Aramide fiber	Kevlar fiber and impregnated glass fiber
• Outer sheath/color of cable	PVC, green	PVC, black
Mechanical characteristics		
• Dimensions of basic element	2.9 mm diam.	(3.5 ± 0.2) mm diam.
• Cable dimensions	4.5 x 7.4 mm	(6.3 × 9.8) ± 0.4 mm
• Cable weight	Approx. 40 kg/km	Approx. 74 kg/km
• Permissible tensile force	≤ 500 N	≤ 500 N (temporary)
• Bending radius	70 mm	≥ 100 mm only on the flat side
• Resistance to lateral force	300 N/cm	–
Permissible ambient conditions		
• Routing and installation temperature	-5 ... +50 °C	-5 ... +50 °C
• Operating temperature	-25 ... +80 °C	-20 ... +60 °C
• Storage temperature	-25 ... +80 °C	-25 ... +70 °C
Behavior in fire	–	Flame-retardant to IEC 60332-3 and VDE 0482-266-2-4
Silicone-free	Yes	Yes
Resistance to mineral oils and grease	Limited resistance	–
UL/CSA approvals	OFNG, UL1651 FT4/IEEE1202	–
UV-resistant	Yes	–
Rodent protection	–	Yes
Gigabit length		
• 1000BaseSX	750 m	–
• 1000BaseLX	2000 m	–

Passive network components: Fiber-optic cables

Selection and Ordering Data	Order No.
FO Standard Cable 50/125 ¹⁾ Preferred lengths, preassembled with 2 x 2 SC connectors: <ul style="list-style-type: none"> • 1 m • 3 m • 5 m • 10 m • 20 m • 50 m • 100 m • 200 m • 300 m 	6XV1 873-6AH10 6XV1 873-6DH30 6XV1 873-6DH50 6XV1 873-6AN10 6XV1 873-6DN20 6XV1 873-6DN50 6XV1 873-6AT10 6XV1 873-6AT20 6XV1 873-6GT30
FIBER OPTIC CABLE standard cable 62.5/125, splittable ¹⁾ Preferred lengths, preassembled with 2 x 2 BFOC (ST) connectors: <ul style="list-style-type: none"> • 1 m • 3 m • 5 m • 10 m • 20 m • 50 m • 100 m • 200 m • 300 m 	6XV1 820-5BH10 B) 6XV1 820-5BH30 B) 6XV1 820-5BH50 B) 6XV1 820-5BN10 B) 6XV1 820-5BN20 B) 6XV1 820-5BN50 B) 6XV1 820-5BT10 B) 6XV1 820-5BT20 B) 6XV1 820-5BT30 B)
BFOC (ST) connector set For FIBER OPTIC CABLE standard cable, 20 units	6GK1 901-0DA20-0AA0 B)

B) Subject to export regulations: AL: N, ECCN: EAR99H

¹⁾ Special tools and specially trained personnel are required for pre-assembling glass fiber-optic cables.

Other lengths and other fiber-optic cables can be found in Catalog IK PI.

Note:

Supplementary components for the SIMATIC NET cable range can be ordered from your local contact person. For technical support, please contact:

J. Hertlein, A&D SE PS

Tel.: +49 911 750-4465

Fax: +49 911 750-9991

E-mail: juergen.hertlein@siemens.com

Further information on assembly is provided in the manual for TP and fiber-optic networks.

Communication Industrial Ethernet

System connection PCS 7 systems

Design

Connection of single stations, servers and clients

SIMATIC PCS 7 subsystems for engineering, operation and monitoring (also via Internet/Intranet), batch control, route control, asset management or IT applications are distributed between various SIMATIC PCS 7 Industrial Workstations of single station, server or client design depending on the configuration. Depending on their task and the associated integration into the complete system, these SIMATIC PCS 7 Industrial Workstations are connected either only on the plant bus, only on the OS LAN (terminal bus) or on both buses of the Industrial Ethernet network. The redundant or non-redundant connection is made using onboard interfaces, simple network cards or special communications processors (e.g. CP 1613).



CP 1613

Connection to plant bus

Single stations and servers can be operated on the plant bus via Basic Communication Ethernet (network card plus BCE license) or CP 1613 communication. CP 1613 communication is always required for ES/OS single stations and OS servers if an operator system has more than 8 subordinate automation systems or if fault-tolerant automation systems are used. In all other cases, the more cost-effective Basic Communication Ethernet (BCE) can be used instead.

BCE and CP 1613 communication is embedded in each case in an alternative SIMATIC PCS 7 Workstation for single station and server.

The separately available desktop adapter network card can also be used for BCE. The BCE license is already included with SIMATIC PCS 7 Workstations. If you use alternative hardware instead for your stations, you require an additional BCE license for each station which communicates over the plant bus via BCE.

The CP 1613 communication delivered with SIMATIC PCS 7 Workstations for single stations and servers instead of BCE is a combination of CP 1613 communications processor and S7-1613 communications software. However, if fault-tolerant automation systems are used, ES/OS single stations and OS servers require the S7-REDCONNECT software instead of the S7-1613 communications software. ES/OS single stations and OS servers with S7-1613 communications software can be accordingly upgraded in this case using the S7-REDCONNECT Upgrade (see also page 9/28).

Single stations and servers with BCE can also be subsequently upgraded to CP 1613 communication. Depending on the above-mentioned criteria, either the S7-1613 communications software or the S7-REDCONNECT software is required in addition to the CP 1613 communications processor.

Connection to OS LAN (terminal bus)

SIMATIC PCS 7 Industrial Workstations in client, server or single station designs are connected as standard to the OS LAN via the onboard Industrial Ethernet interface. In the case of servers or single stations without a connection to the plant bus, the network card envisaged for BCE can be used as an alternative.

The OS LAN can also have a redundant configuration, where two rings are connected together via two pairs of switches (see also "Introduction" at the beginning of the catalog section on Industrial Ethernet). A "SIMATIC PCS 7 Redundant Terminal Bus Adapter Package", comprising server and desktop adapter network cards, is required to connect the stations to the two rings of the redundant OS LAN.

Connection of automation systems

The SIMATIC PCS 7 automation systems communicate with other subsystems of the process control system (e.g. operator system or engineering system) via the Industrial Ethernet plant bus. The automation systems are connected to the plant bus using the CP 443-1 communications processor, also redundant in the case of fault-tolerant systems.

Selection and Ordering Data	Order No.
System connection of single stations, servers and clients	
Desktop adapter network card for BCE and as spare part for redundant terminal bus INTEL PCI network card for connection to Industrial Ethernet (10/100/1000 Mbit/s), with RJ45 connection	A5E00504378 B)
SIMATIC PCS 7 Redundant Terminal Bus Adapter Package Server and desktop adapter for designing a redundant terminal bus, consisting of 2 Intel PCI network cards for connection to Industrial Ethernet (10/100/1000 Mbit/s), with RJ45 connection	6ES7 652-0XX01-1XF0 B)
CP 1613 A2 PCI card for connection to Industrial Ethernet, with ITP and RJ45 connections	6GK1 161-3AA01 B)
SIMATIC NET S7-1613/2006 for Industrial Ethernet S7 communications software for CP 1613, runtime software, in 2 languages (German, English), executes with Windows 2000 Professional/ 2000 Server/ XP Professional/ Server 2003, single license for 1 installation, software and electronic manual on CD-ROM, license key on diskette	6GK1 716-1CB64-3AA0
SIMATIC NET S7-REDCONNECT/2006 Software for fail-safe S7 communication over redundant networks, for CP 1613, runtime software, in 2 languages (German, English), executes with Windows 2000 Professional/ 2000 Server/ XP Professional/ Server 2003, single license for 1 installation, software and electronic manual on CD-ROM, license key on diskette	6GK1 716-0HB64-3AA0
SIMATIC NET S7-REDCONNECT/2006 Upgrade Software for expansion of S7-1613 to S7-REDCONNECT, runtime software, in 2 languages (German, English), executes with Windows 2000 Professional/ 2000 Server/ XP Professional/ Server 2003, single license for 1 installation, software and electronic manual on CD-ROM, license key on diskette	6GK1 716-0HB64-3AC0

Selection and Ordering Data	Order No.
System connection of single stations and servers which are not based on the SIMATIC PCS 7 Industrial Workstation	
PCS 7 BCE V7.0 Runtime license for plant bus communication via standard network card and Basic Communication Ethernet; already integrated in SIMATIC PCS 7 Industrial Workstations, in 3 languages (German, English, French), executes with Windows XP Professional or Windows Server 2003, floating license for 1 user Type of delivery: License key disk, certificate of license, terms and conditions	6ES7 650-1CD07-2YB5

System connection of automation systems	
CP 443-1 Communications processor for connection of SIMATIC S7-400 to Industrial Ethernet through TCP/IP, ISO and UDP; for S7 communication, S5-compatible communication (SEND/RECEIVE) with FETCH/WRITE with or without RFC 1006, diagnostics expansion, Multicast, commissioning through LAN 10/100 Mbit/s, with electronic manual on CD-ROM	6GK7 443-1EX11-0XE0

B) Subject to export regulations: AL: N, ECCN: EAR99H

Communication Industrial Ethernet

Industrial Wireless LAN (IWLAN)

Overview

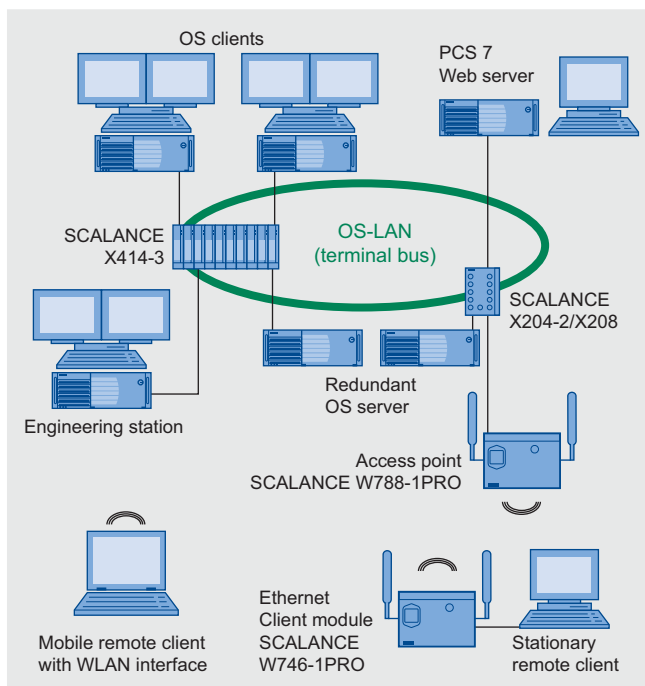

SIMATIC PCS 7 allows you to integrate mobile or stationary remote clients into the OS-LAN (terminal bus) via a SCALANCE W788-1PRO access point.

The following applications can be implemented in this manner:

- Use of additional remote OS clients (1 or 2 on IWLAN)
- Linking of Web clients to a SIMATIC PCS 7 Web server (1 or 2 on IWLAN)
- Remote access to an engineering station with application of Remote Desktop (Windows XP or Server 2003 operating system) or PC Anywhere, e.g. during commissioning

Mobile remote clients (e.g. notebooks) possessing a WLAN interface can communicate with the access point via it. Stationary remote clients in a desktop/tower housing (SIMATIC PCS 7 Industrial Workstations) require a SCALANCE W746-1PRO Ethernet client module for the IWLAN communication with the access point.

SCALANCE W746-1PRO Ethernet client module and SCALANCE W788-1PRO access point are both very rugged, use state-of-the-art authentication and encryption procedures, and guarantee high reliability of the radio channel.

Note:

Please note that Industrial Wireless LAN is not approved of as a terminal bus (OS-LAN) or plant bus of SIMATIC PCS 7.

Design

SCALANCE W746-1PRO Ethernet client module



The SCALANCE W746-1PRO Ethernet client module is highly suitable for integrating devices with an Industrial Ethernet connection into Industrial Wireless LAN (IWLAN) radio networks with reliable communication. The SCALANCE W746-1PRO Ethernet client module handles the radio connection for a maximum of eight connected devices with Ethernet interface. If one of the connected devices is exchanged, the Ethernet client module recognizes this immediately and administers the new address.

Special features of the SCALANCE W746-1PRO Ethernet client module

- Versatile power supply facilities (operation on 100 V to 240 V AC network with PS791-1PRO power supply)
- Antenna diversity for reliable reception in complex radio environments with two AN795-4MR omnidirectional antennas screwed onto the housing, can be replaced by other types from the SCALANCE W700 range
- Transmission rate up to 54 Mbit/s at 2.4 GHz and 5 GHz with radio approval in more than 30 countries
- Conforms to the IEEE 802.11b/g and IEEE 802.11a standards
- High reliability through reservation of data transfer rate with IWLAN communication with SCALANCE W788-1PRO access point
- WPA and 128-bit encryption (AES) for high security against illegal access
- Rugged metal enclosure resistant to shock and vibration, and with IP65 dust protection
- Suitable for ambient temperatures from -20 to +60°C (resistant to condensation)

For further information and detailed technical specifications, refer to Catalog IK PI, the A&D Mall or Catalog CA 01 under "Communication/networks, SIMATIC NET communication systems, Industrial mobile communication".

SCALANCE W788-1PRO access point



The SCALANCE W788-1PRO access point is highly suitable for designing Industrial Wireless LAN (IWLAN) radio networks with reliable communication. It has an Industrial Ethernet interface for the connection to the wire-bound network.

Special features of the SCALANCE W788-1PRO access point

- Versatile power supply facilities (operation on 100 V to 240 V AC network with PS791-1PRO power supply)
- Antenna diversity for reliable reception in complex radio environments with two ANT795-4MR omnidirectional antennas screwed onto the housing, can be replaced by other types from the SCALANCE W700 range
- Transmission rate up to 54 Mbit/s at 2.4 GHz and 5 GHz with radio approval in more than 30 countries
- Conforms to the IEEE 802.11b/g and IEEE 802.11a standards
- WPA and 128-bit encryption (AES) for high security against illegal access
- Rugged metal enclosure resistant to shock and vibration, and with IP65 dust protection
- Suitable for ambient temperatures from -20 to +60°C (resistant to condensation)

For further information and detailed technical specifications, refer to Catalog IK PI, the A&D Mall or Catalog CA 01 under "Communication/networks, SIMATIC NET communication systems, Industrial mobile communication".

Integration

The data and power connections for the SCALANCE W746-1PRO Ethernet client module and the SCALANCE W788-1PRO access point can be made using a hybrid cable or separate cables (preferably over short distances):

- With separate cables, a 4-core TP (2 x 2) IE FC Standard Cable (type A) is used as the data cable. This Industrial Ethernet cable is connected on site to the supplied IP67 hybrid plug connector. A Power M12 Cable Connector PRO is additionally required for the power supply. IE FC Standard Cable and Power M12 Cable Connector PRO must be ordered in addition.

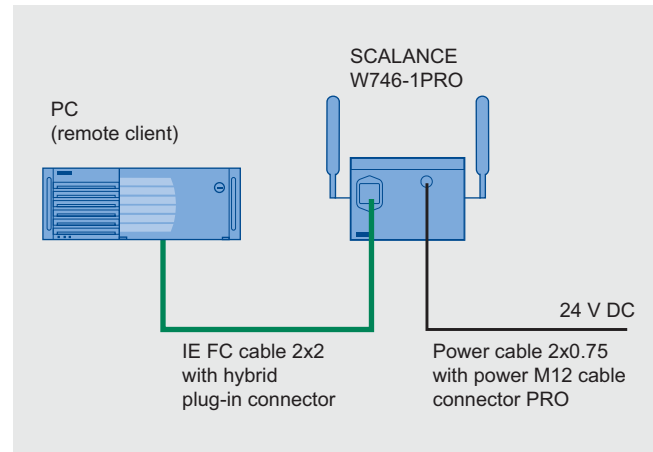

Example of data and power supply connections using separate cables

- If the data and power supply are connected using one cable, an FC Modular Outlet with power insert and the hybrid cable must be ordered in addition. The hybrid connector included in the scope of supply and the FC Modular Outlet with power insert can be assembled and connected on site.

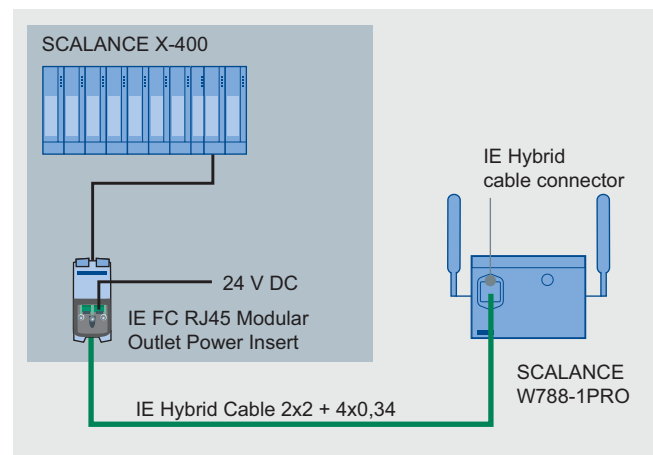

Example of data and power supply connections using a hybrid cable

- If 100 ... 240 V AC is available on site, the PS791-1PRO power supply can be used (to be ordered in addition). It is supplied including AC connector and cable to the Ethernet client module/access point, but without AC cable.

Communication Industrial Ethernet

Industrial Wireless LAN (IWLAN)

Selection and Ordering Data

Order No.

Stationary remote client

SCALANCE W746-1PRO

IWLAN Ethernet client module with built-in radio interface; IEEE 802.11b/g/a radio networks at 2.4/5 GHz up to 54 Mbit/s. Country approvals; WPA/AES; Power over Ethernet (PoE), IP65 protection (-20 to +60 °C)

for administration of the radio connection of up to eight linked devices with Industrial Ethernet connection

Scope of delivery:

Two ANT795-4MR antennas, IP67 hybrid connector, mounting material, manual on CD-ROM (German, English)

- Country approvals for operation outside the USA and Canada
- Country approvals for operation in the USA and Canada

6GK5 746-1ST00-2AA6 G)

6GK5 746-1ST00-2AB6 G)

Access point

SCALANCE W788-1PRO

IWLAN access point with built-in radio interface; IEEE 802.11b/g/a radio networks at 2.4/5 GHz up to 54 Mbit/s. Country approvals; WPA/AES; Power over Ethernet (PoE), IP65 protection (-20 to +60 °C)

Scope of delivery:

Two ANT795-4MR antennas, IP67 hybrid connector, mounting material, manual on CD-ROM (German, English)

- Country approvals for operation outside the USA and Canada
- Country approvals for operation in the USA and Canada

6GK5 788-1ST00-2AA6 G)

6GK5 788-1ST00-2AB6 G)

Components for system connection

Data and power connection via separate lines

IE FC Standard Cable GP 2 x 2

4-core (2 x 2), shielded TP installation cable for universal use, can be connected to IE FC Outlet RJ45/IE FC RJ45 Plug; cut-to-length; max. delivery unit 1000 m, minimum ordering quantity 20 m

6XV1 840-2AH10

Power M12 Cable Connector PRO

Socket for connection of SCALANCE W-700 for 24 V DC supply; 4-pole, a-coded, with mounting instructions, 3 units

6GK1 907-0DC10-6AA3

Data and power connection via common line

IE FC Standard Cable GP 2 x 2

4-core (2 x 2), shielded TP installation cable for universal use, can be connected to IE FC Outlet RJ45/IE FC RJ45 Plug; cut-to-length; max. delivery unit 1000 m, minimum ordering quantity 20 m

6XV1 840-2AH10

Selection and Ordering Data

Order No.

IE FC RJ45 Modular Outlet with Power Insert

Fast Connect RJ45 Modular Outlet for Industrial Ethernet with a power insert for 1 x 24 V and 1 x 100 Mbit/s interface

6GK1 901-1BE00-0AA3

IE Hybrid Cable 2x2 + 4x0.34

4-core, shielded installation cable; cut-to-length; max. delivery unit 1000 m, minimum ordering quantity 20 m

6XV1 870-2J

IP 67 hybrid connector

(1 unit included in delivery of SCALANCE W746/788)

Plug for connection of SCALANCE W-700 to Industrial Ethernet and Power over Ethernet (PoE), with mounting instructions, 1 unit

09 45 125 1300.00¹⁾

Power supply for 100 to 240 V AC

PS791-1PRO power supply

AC/DC power supply, 10 W, IP65 (-20 to +60°C), input: 90 to 265 V AC, output: 24 V DC, metal enclosure

Scope of delivery:

AC power 3+PE cable connector, DC power cord M12, mounting material, operating instructions (German, English)

6GK5 791-1PS00-0AA6 G)

Accessories

For antennas and further accessories for access points and Ethernet client modules, refer to Catalog IK PI, the A&D Mall or Catalog CA 01 under "Communication/networks, SIMATIC NET communication systems, Industrial mobile communication"

G) Subject to export regulations: AL: N, ECCN: 5A002ENC3

¹⁾ Order directly from:

HARTING Deutschland GmbH & Co KG
P.O. Box 2451
D-32381 Minden
Tel. +49 571-8896-0
Fax. +49 571-8896-354
E-mail: de.sales@HARTING.com
Internet: www.HARTING.com

Further information on country approvals

Additional information is available in the Internet under:



<http://www.siemens.com/simatic-net/ik-info>

More information

Note:

Supplementary components for the SIMATIC NET cable range can be ordered from your local contact person. Technical advice on this subject is available from:

J. Hertlein A&D SE PS
Tel. +49 (0)911/750 44 65
Fax. 0911/750 99 91
E-mail: juergen.hertlein@siemens.com

Overview

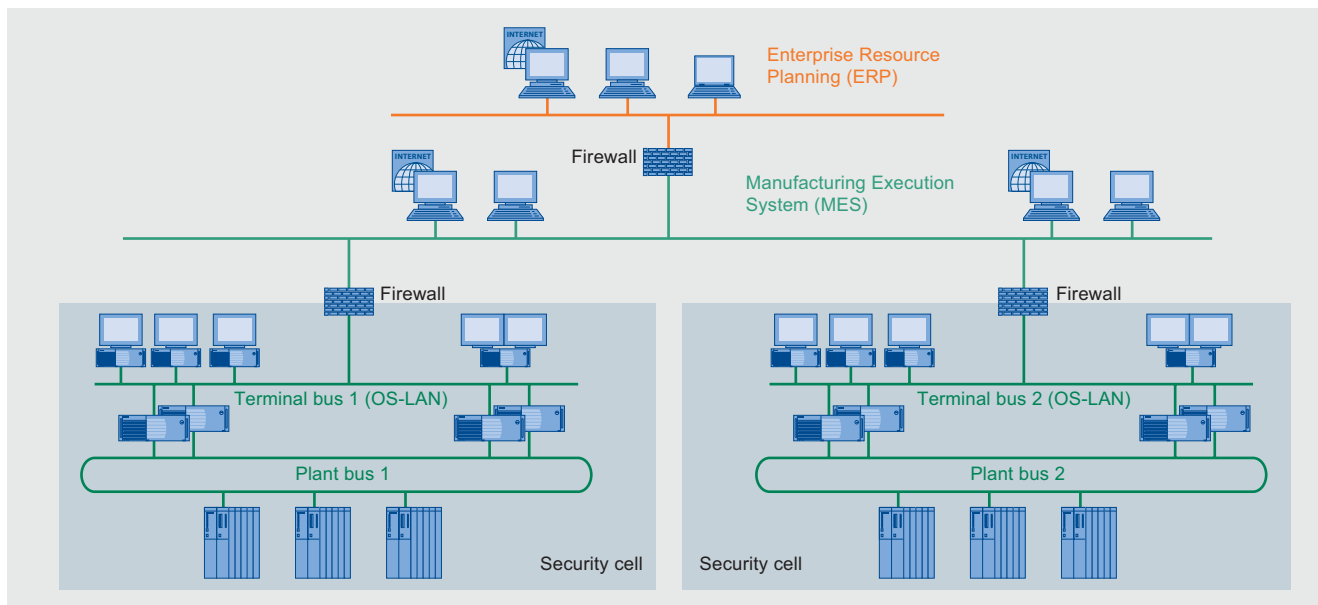

Example of "defense in depth" security architecture

The progressive standardization, opening and networking of control systems has been accompanied by an enormous increase in security risks. The potential dangers arising from destructive programs such as computer viruses, worms or trojans or from access by unauthorized personnel range from network overloads or failures, theft of passwords and data, to unauthorized access to the process automation. Apart from material damage, specifically targeted sabotage can also have dangerous consequences for people and the environment.

Function

With its pioneering security concept, SIMATIC PCS 7 offers comprehensive solutions for safeguarding a process engineering plant that are based on a hierarchical security architecture (defense in depth). The special feature of this concept is its integrated approach. It is not just restricted to the use of individual security methods (e.g. encryption) or devices (e.g. firewalls). Its strengths lie more in the interaction of a host of security measures in the plant network. The security concept is described in detail in the manual "SIMATIC PCS 7 recommendations and information", and comprises advice and recommendations (best practices) on the following topics:

- Creation of a network architecture with defense in depth, combined with the segmentation of the plant into security cells
- Network administration with name resolution, assignment of IP addresses and division into subnetworks
- Operation of plants in Windows domains (active directory)
- Administration of the Windows and SIMATIC PCS 7 operator privileges; integration of the SIMATIC PCS 7 operator privileges into the Windows administration
- Reliable control of the clock synchronization in the Windows network
- Management of security patches for Microsoft products
- Use of antivirus software and firewalls
- Support and remote access (VPN, IPSec)

On the system side, SIMATIC PCS 7 V7.0 supports the implementation of guidelines and recommendations of the security concept by means of:

- Compatibility with the current versions of the antivirus software: Trend Micro OfficeScan, Symantec Norton AntiVirus and McAfee Virusscan
- Application of the local Windows XP firewall
- SIMATIC security control (SSC) for automatic setting of safety-related parameters of DCOM, registry and Windows firewall during the setup
- User administration and authentication by means of SIMATIC Logon
- Integration of the SCALANCE S602, S612 and S613 industrial security modules of SIMATIC NET

The manual "SIMATIC PCS 7 Security Concept, Recommendations and Advice" is available on the Internet via the SIMATIC Guide for Technical Documentation under "SIMATIC PCS 7 Process Control Systems & Migration".

You can find the SIMATIC Guide for Technical Documentation on the Internet.

Additional information is available in the Internet under:



<http://www.siemens.com/simatic-docu>

Communication

Industrial Security

Industrial Security components

Overview



The SCALANCE S industrial security modules can safeguard industrial systems/devices or network segments of an Ethernet against unauthorized access by means of a firewall. Some of them, e.g. SCALANCE S612 and S613, additionally use encryption and authentication (VPN) to protect the data transmission between systems/devices or network segments against data manipulation and espionage.

Design

SCALANCE S industrial security modules

The following SCALANCE S industrial security modules can be used in the context of the SIMATIC PCS 7 security concept:

- SCALANCE S602 industrial security module with firewall functionality
- SCALANCE S612 industrial security module with firewall functionality and VPN (Virtual Private Network) functionality for up to 32 devices (up to 64 simultaneous VPN tunnels)
- SCALANCE S613 industrial security module with firewall functionality and VPN (Virtual Private Network) functionality for up to 64 devices (up to 128 simultaneous VPN tunnels); suitable for extended temperature range from -20 to +70 °C.

Security functions of the SCALANCE S industrial security modules

- Firewall functionality (S602, S612 and S613)
 - Filtering of data packets as well as enabling or blocking of communication links on the basis of filter lists (packet filter firewall); IP and MAC addresses can be filtered, as well as communication protocols (ports) with incoming and outgoing communication.
 - Saving of access data in a log file; for verification purposes and for recognition of attacks and derivation of preventive measures.
- VPN functionality (S612 and S613)
 - Secure authentication (identification) of the network nodes through monitoring and checking the incoming data traffic using proven VPN mechanisms.
 - Data encryption and data integrity checking for protection against espionage and data manipulation; establishment of VPN tunnels to other security modules

Configuration

Using the supplied configuration tool, it is easy to create and configure the security modules which are to communicate securely with one another. You do not require any special IT knowledge.

The complete configuration can be saved on the optional swap medium C-PLUG (order separately) and transmitted to another security module. This permits easy and fast replacement of modules in the event of a fault.

Selection and Ordering Data

Order No.

SCALANCE S industrial security modules

SCALANCE S602 Industrial security module for protection against unauthorized access by means of Stateful Inspection Firewall	6GK5 602-0BA00-2AA3	F)
SCALANCE S612 Industrial security module for protection against unauthorized access by means of Stateful Inspection Firewall as well as for protection of up to 32 devices per VPN tunnel (up to 64 VPN tunnels simultaneously)	6GK5 612-0BA00-2AA3	F)
SCALANCE S613 Industrial security module for protection against unauthorized access by means of Stateful Inspection Firewall as well as for protection of up to 64 devices per VPN tunnel (up to 128 VPN tunnels simultaneously); suitable for extended temperature range from -20 to +70 °C	6GK5 613-0BA00-2AA3	F)

Accessories

C-PLUG Swap medium for simple replacement of devices in event of fault; for saving of configuration and application data, can be used in SIMATIC NET products with C-PLUG slot	6GK1 900-0AB00	B)
--	-----------------------	----

B) Subject to export regulations: AL: N, ECCN: EAR99H
F) Subject to export regulations: AL: N, ECCN: 5D002ENC3

Note:

For further components and accessories, especially cable material and connectors as well as tools and supplementary material for assembly, refer to page 9/23, 9/25 and 9/26 as well as to Catalog IK PI.

Overview

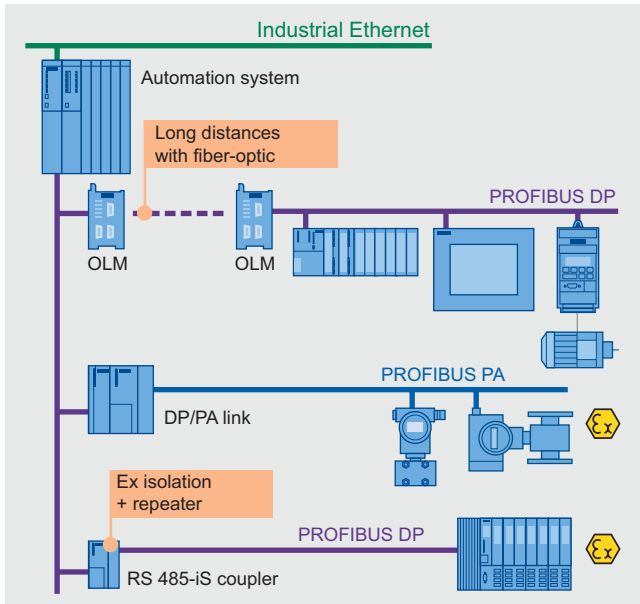

Communication at field level with PROFIBUS

Distributed peripherals such as remote I/O stations with their I/O modules, transmitters, drives, valves or operator terminals communicate with the automation systems (controllers) at field level through a powerful real-time bus system. This communication is characterized by:

- Cyclic transmission of process data
- Acyclic transfer of interrupts, parameters and diagnostics data

PROFIBUS is predestined for these tasks because it enables high-speed communication with the intelligent distributed I/Os by means of a communications protocol (PROFIBUS DP) as well as communication and simultaneous power supply for transmitters and actuators (PROFIBUS PA).

PROFIBUS is simple, rugged and reliable, can be expanded on-line by further distributed components, and can be used in both standard environments and hazardous areas. It supports the co-existence of field devices from different vendors on one line (interoperability) as well as the vendor-independent exchangeability of devices from one profile family.

Benefits

SIMATIC PCS 7 utilizes the benefits of the PROFIBUS from start to finish:

- Small planning and engineering overheads as well as low commissioning costs
- Optimum distributed system structure with low hardware and space requirements
- Significantly reduced overhead for wiring, jumpering, distribution, power supply and field mounting
- High-speed communication with high measurement accuracy
- Efficient engineering, interoperability and replaceability of devices through vendor-independent device description
- Short commissioning times through short loop tests, easy parameterization and the elimination of calibration work
- Bidirectional communication and high amounts of information permit enhanced diagnostics functions for fast fault locating and troubleshooting
- Optimum life cycle management through processing and evaluation of diagnostics and status information by an asset management system

Function

Users have numerous facilities for communication and line diagnostics, as well as for diagnostics of the intelligent field devices connected. Furthermore, the PROFIBUS is fully integrated into the global asset management of the SIMATIC PCS 7 process control system.

In addition to all these properties, the following PROFIBUS functions are particularly relevant to process automation:

- Integration of previously installed HART devices
- Redundancy
- Safety-related communication with PROFIsafe up to SIL 3 according to IEC 61508
- Clock synchronization
- Time tagging

On account of its exceptional characteristics, PROFIBUS is now established in all sectors of the production, process and hybrid industries and has become the most successful open field bus in the world.

PROFIBUS transmission systems

PROFIBUS DP

- RS 485: simple and low-cost electrical transmission system based on shielded two-wire cable.
- RS 485-iS: intrinsically-safe electrical transmission system for hazardous areas up to Ex zone 1, implemented using a shielded two-wire cable with a transmission rate of 1.5 Mbit/s.
- Fiber-optic: optical transmission system with glass or plastic fiber-optic cables, for fast transmission of large quantities of data in environments with high interferences or for covering long distances.

PROFIBUS PA

- MBP (Manchester Coded; Bus Powered): intrinsically-safe transmission system which permits simultaneous transmission of digital data and powering of the field devices on a single two-wire cable. It is suitable for direct connection of devices in environments up to Ex zone 1 or 21 and associated sensors/actuators in environments up to Ex zone 0 or 20.

Communication

PROFIBUS DP

Introduction

Application

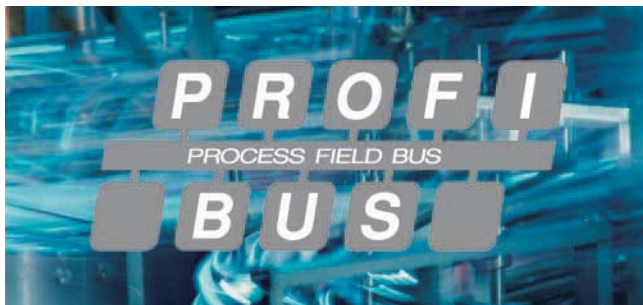

The PROFIBUS DP fieldbus enables the SIMATIC PCS 7 automation systems (controllers) to communicate with distributed I/Os from the ET 200 range (remote I/Os) as well as with field/process devices, CPUs/CPs and operator terminals that have a PROFIBUS DP interface. It is possible to route the PROFIBUS DP into Ex zone 1 by using a fieldbus isolating transformer (RS 485-iS coupler) and the RS 485-iS transmission technology. Connection of the intelligent, distributed field/process devices and operator terminals on PROFIBUS PA to the automation system takes place likewise through PROFIBUS DP.

Depending on the type of automation system and the number of available slots, up to 4 PROFIBUS DP lines can be connected to

a SIMATIC PCS 7 automation system through internal interfaces in the CPU, and up to 10 PROFIBUS DP lines through additional CP 443-5 Extended communications processors. On a PROFIBUS DP line it is possible to operate up to 125 devices, and on a bus segment up to 31 devices with PROFIBUS DP interface (32 stations).

Electrical and optical transmission technologies offer many different configuration options for PROFIBUS DP networks. Electrical networks can span up to approx. 10 km. With optical transmission systems, the total size of the network is governed primarily by the cycle times as a result of the almost loss-free transmission.

With SIMATIC PCS 7, PROFIBUS DP topologies are always implemented through the standard electrical PROFIBUS DP connection on the automation system in the form of electrical or mixed (electrical/optical) networks. In the case of mixed networks, the transition between the two media is implemented by an optical link module (OLM). As regards communication between the stations, there is no difference between electrical two-wire technology and fiber optic technology.

Electrical networks can be configured with a line or tree topology. Mixed electrical/optical networks with OLMs as routers can be configured with a line, ring or star topology.

Technical specifications

PROFIBUS DP			
Data transmission	RS 485	RS 485-iS	Fiber-optic
Transmission rate	9.6 kbit/s ... 12 Mbit/s	9.6 kbit/s ... 1.5 Mbit/s	9.6 kbit/s ... 12 Mbit/s
Cable	2-wire shielded	2-wire shielded	Plastic as well as multi-mode and single-mode glass-fiber
Type of protection		EEx(ib)	
Topology	Line, tree	Line	Ring, star, line
Nodes per segment	32	32 ¹⁾	–
Nodes per network (with repeater)	126	126	126
Cable length per segment dependent on transmission rate	1200 m at max. 93.75 kbit/s 1000 m at 187.5 kbit/s 400 m at 500 kbit/s 200 m at 1.5 Mbit/s 100 m at 12 Mbit/s	1000 m at 187.5 kbit/s ¹⁾ 400 m at 500 kbit/s ¹⁾ 200 m at 1.5 Mbit/s ¹⁾	Max. 80 m (plastic) 2-3 km (multi-mode glass-fiber) > 15 km at 12 Mbit/s (single-mode glass-fiber)
Repeater for signal refreshing with RS 485 networks	Max. 9	Max. 9 ¹⁾	Not relevant

¹⁾ According to PROFIBUS installation guideline 2.262

Overview

Shielded twisted-pair cables are used as the transmission medium for electric PROFIBUS DP networks. The PROFIBUS DP stations are connected to these bus lines through a bus connector (max. 32 stations per segment).

Design



FastConnect Stripping Tool

FastConnect

PROFIBUS FastConnect is a system for fast and easy assembly of PROFIBUS copper cables. The system comprises compatible components:

- FastConnect Standard Cable for fast assembly
- FastConnect Stripping Tool with FastConnect Blade Cassettes (spare blade cassettes for the stripping tool)
- FastConnect bus connector for PROFIBUS

Repeater for PROFIBUS

A repeater links the individual bus segments with RS 485 technology. Main applications are:

- Increase in number of nodes and distances
- Electrical isolation of segments

If diagnostics functions for physical cable diagnostics are required in addition to the standard repeater functionality, a diagnostics repeater can be alternatively used. It additionally performs physical online monitoring of the copper bus cables. In the event of a fault it sends a diagnostic message with detailed information about the type and location of the fault to the DP master.

Active RS 485 terminating element

The active RS 485 terminating element is used to terminate bus segments. The component supplied with 24 V DC independent of the bus stations provides a defined RS 485 signal level, and suppresses reflections on the line. Bus stations (e.g. ET 200S) can be coupled and decoupled without feedback to/from PROFIBUS networks terminated by active RS 485 terminating elements.

RS 485-iS coupler

The RS 485-iS coupler is an isolating transformer with which the PROFIBUS DP fieldbus can be routed intrinsically-safe into the hazardous area.

The RS 485-iS coupler has the following functions:

- Connection of intrinsically-safe PROFIBUS DP stations, e.g. ET 200iSP, ET 200iS or devices from other vendors with Ex i DP connection
- Conversion of the electrical PROFIBUS DP RS 485 transmission technology into the intrinsically-safe RS 485-iS transmission technology with a transmission rate of 1.5 Mbit/s
- Suitable as a safety barrier
- Additional use as a repeater in the hazardous area.

The RS 485-iS coupler as an open unit can only be used in housings, cabinets or rooms for electrical equipment. It is assembled on a SIMATIC S7-300 rail which can be positioned horizontally or vertically.

The RS 485-iS coupler is integrated into the PROFIBUS as follows:

- Connection to standard PROFIBUS DP via standard Sub-D socket (at the bottom on the RS 485-iS coupler, behind the right front door).
- Connection of PROFIBUS DP with RS 485-iS transmission technology via screw terminals (at the top of the RS 485-iS coupler, behind the right front door)
- The last bus station on the intrinsically-safe PROFIBUS DP segment (not further RS 485-iS couplers) must be terminated by a selectable resistance using the connector, Order No. 6ES7 972-0DA60-0XA0.

Communication

PROFIBUS DP

Electrical networks

Selection and Ordering Data

Order No.

PROFIBUS FastConnect Standard Cable

Standard type with special design for fast mounting, 2-core, shielded, cut-to-length

Specify length in m
Max. delivery unit 1000 m,
minimum order quantity 20 m

Preferred lengths

- 20 m
- 50 m
- 100 m
- 200 m
- 500 m
- 1000 m

6XV1 830-0EH10

6XV1 830-0EN20

6XV1 830-0EN50

6XV1 830-0ET10

6XV1 830-0ET20

6XV1 830-0ET50

6XV1 830-0EU10

Other PROFIBUS cables

See Catalog IK PI

PROFIBUS FastConnect Stripping Tool

Preadjusted stripping tool for fast stripping of PROFIBUS FastConnect bus cables

6GK1 905-6AA00

PROFIBUS FastConnect Blade Cassettes

Spare blade cassettes for PROFIBUS FastConnect stripping tool, 5 units

6GK1 905-6AB00

PROFIBUS FastConnect bus connector RS 485 with 90° cable outlet

With insulation displacement system, max. data transfer rate 12 Mbit/s

- Without PG interface
- With PG interface

6ES7 972-0BA50-0XA0

6ES7 972-0BB50-0XA0

PROFIBUS FastConnect bus connector RS 485 Plug 180

With 180° cable outlet, with insulation displacement system, for connection of PC, PG, OP

Other bus connectors
See Catalog IK PI

6GK1 500-0FC00

RS 485 Repeater for PROFIBUS

Data transfer rate max. 12 Mbit/s, 24 V DC, IP 20 housing

6ES7 972-0AA01-0XA0

RS 485 Diagnostic Repeater

For connection of 1 or 2 segments to PROFIBUS DP; with online diagnostics functions for monitoring of bus cables

6ES7 972-0AB01-0XA0

Active RS 485 Terminating Element for PROFIBUS

For terminating bus segments for data transfer rates from 9.6 kbit/s to 12 Mbit/s

6ES7 972-0DA00-0AA0

Selection and Ordering Data

Order No.

RS 485-IS Coupler

Isolating transformer for connection of PROFIBUS DP segments with RS 485 and RS 485-iS transmission technologies

6ES7 972-0AC80-0XA0

PROFIBUS connector with selectable terminating resistor

For connection of IM 152 to PROFIBUS DP with RS 485-iS transmission technology

6ES7 972-0DA60-0XA0 B)

S7-300 rail

Lengths:

- 160 mm
- 482 mm
- 530 mm
- 830 mm
- 2000 mm

6ES7 390-1AB60-0AA0

6ES7 390-1AE80-0AA0

6ES7 390-1AF30-0AA0

6ES7 390-1AJ30-0AA0

6ES7 390-1BC00-0AA0

B) Subject to export regulations: AL: N, ECCN: EAR99H

Note:

For further information on electrical PROFIBUS networks as well as components and accessories, particularly cable material for special applications, refer to Catalog IK PI, Chapter "PROFIBUS", Section "Electrical networks with OLM".

Optical networks with glass fiber-optic cables

Overview

We recommend use of glass fiber optic cables with 2 multi-mode fibers for optical PROFIBUS networks in indoor and outdoor areas.

The standard FIBER OPTIC CABLE is available in fixed lengths for distances up to 2000 m, preassembled with 4 BFOC connectors. A BFOC connector set with 20 connectors is available as an accessory.

Further fiber optic cables can be found in Catalog IK PI, Chapter "PROFIBUS", Section "Optical networks with OLM".

Optical Link Module

Optical Link Modules (OLM) permit the construction of optical and hybrid (electrical/optical) networks in line, ring or star topology. The maximum distance between two OLMs can be up to 15 km for OLMs of type G12-1300 (see Catalog IK PI) and glass fiber optic cables with single-mode fibers (on request). The PROFIBUS OLM/G12 used as standard is equipped with one RS 485 interface and two glass fiber optic cable interfaces (4 BFOC sockets). The fiber optic line length between two OLMs of this type can be up to 3000 m when using the standard FIBER OPTIC CABLE.

The OLMs have a compact metal housing suitable for DIN rail assembly. They automatically recognize all PROFIBUS data transfer rates. Faults can be rapidly located as follows:

- Display of module status via floating signaling contact
- Checking of FO link quality (loss per section) via test output for optical receivers for logging and plausibility checks.

Selection and Ordering Data

Order No.

Selection and Ordering Data	Order No.
FIBER OPTIC CABLE Standard glass FO cable, splittable Pre-assembled with 4 BFOC connectors Preferred lengths	
• 1 m	6XV1 820-5BH10 B)
• 5 m	6XV1 820-5BH50 B)
• 10 m	6XV1 820-5BN10 B)
• 20 m	6XV1 820-5BN20 B)
• 50 m	6XV1 820-5BN50 B)
• 100 m	6XV1 820-5BT10 B)
Other lengths and cables	See Catalog IK PI
BFOC Connector Set¹⁾ For standard and trailing FIBER OPTIC CABLES, 20 units	6GK1 901-0DA20-0AA0 B)
PROFIBUS OLM/G12 V4.0 Optical link module with 1 x RS 485 and 2 x glass FOC interfaces (4 BFOC sockets), for standard distances up to 3000 m, with signal contact and measuring output	6GK1 503-3CB00 B)

B) Subject to export regulations: AL: N, ECCN: EAR99H

¹⁾ Note:

Additional components of the SIMATIC NET wiring range can be ordered from your local contact person.

For technical advice contact:

J. Hertlein, A&D SE PS

Tel.: +49 911 750-4465,

Fax: +49 911 750-9991

E-mail: juergen.hertlein@siemens.com

Communication

PROFIBUS DP

Optical networks with plastic fiber-optic cables

Overview

SIMATIC NET plastic/PCF fiber-optic cables can be used to design optical PROFIBUS DP networks inside buildings.

For AS interfacing of ET 200M with exclusively F modules, plastic/PCF fiber-optic cables are an alternative if compliance with safety integrity level SIL 3 is required for the safety-related application. Using plastic/PCF fiber-optic cables, the ET 200M systems are connected to the electrical bus cable of the PROFIBUS DP via optical bus terminals (OBT). The advantage of this configuration is that the isolating module essential for signal decoupling between the IM and the F modules in the case of a direct electrical connection of the ET 200M (only F modules in a rack with IM 153-2) can be omitted.

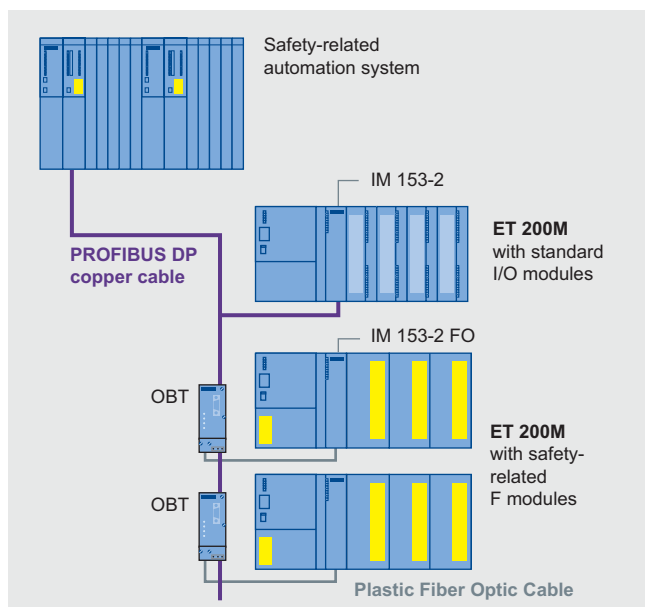

OBT for PROFIBUS DP

Using the OBT (optical bus terminal) for PROFIBUS, it is possible to connect a PROFIBUS DP station with integrated optical interfaces to an RS 485 segment or a PROFIBUS DP station without integrated optical interface. Plastic/PCF fiber-optic cables can be used for the optical connection between the PROFIBUS DP station with integrated optical interface and the OBT.

Design

We particularly recommend the following plastic/PCF standard cables for implementing optical networks in indoor areas:

- PROFIBUS Plastic Fiber Optic standard cable:
 - Rugged round cable with purple PVC outer casing and Kevlar tension-relief elements as well as plastic fibers with rugged polyamide inner casing.
 - Easy to assemble on site with 2 x 2 Simplex connectors
 - Cable lengths up to 50 m
- PROFIBUS PCF Fiber Optic standard cable:
 - Preassembled, rugged round cable with purple PVC outer casing and Kevlar tension-relief elements as well as two PCF fibers (Polymer Optical Fiber)
 - Cannot be assembled on site
 - Cable lengths up to 300 m

Further SIMATIC NET plastic/PCF fiber optic cables can be found in Catalog IK PI, Chapter "PROFIBUS", Section "Optical networks with OBT and integrated interface".

The following components are available for on-site assembly of the PROFIBUS Plastic Fiber Optic standard cable:

- Simplex connector/polishing set (set with 100 simplex connectors and 5 polishing sets)
- Stripping tool set for removing the outer casing and core casing
- You require additional plug adapters for connecting cables with Simplex connectors to devices with integrated FO interfaces (e.g. IM 153-2 FO).

Selection and Ordering Data

Order No.

Selection and Ordering Data	Order No.
PROFIBUS OBT Optical bus terminal for connecting a PROFIBUS station or an RS 485 segment without integrated optical interface to the optical PROFIBUS; without simplex connector	6GK1 500-3AA00
PROFIBUS Plastic Fiber Optic, standard cable Robust round cable with 2 plastic fiber optic cores, PVC external sheath and PA internal sheath, without connectors, for indoor use, cut-to-length	6XV1 821-0AH10
PROFIBUS Plastic Fiber Optic, duplex core Plastic fiber optic cable with 2 cores, PVC sheath, without connectors, for use in environments with low mechanical stress, 50-m ring	6XV1 821-2AN50 B)
PROFIBUS Plastic Fiber Optic, Simplex Connector/Polishing Set 100 simplex connectors and 5 polishing sets for assembling PROFIBUS plastic fiber optic cables for the optical PROFIBUS DP	6GK1 901-0FB00-0AA0 B)
PROFIBUS Plastic Fiber Optic, Stripping Tool Set To remove the external or core sleeve of plastic fiber optic cables	6GK1 905-6PA10 B)
Connection Adapter Pack of 50, for using simplex connectors with the integrated FO interfaces (e.g. IM 153-2 FO); for 25 modules	6ES7 195-1BE00-0XA0

B) Subject to export regulations: AL: N, ECCN: EAR99H

Note:

For further information on optical PROFIBUS networks as well as components and accessories, particularly cable material for special applications, refer to Catalog IK PI, Chapter "PROFIBUS", Section "Optical networks with OLM" and "Optical networks with OBT and integral interface".

Overview



PROFIBUS DP lines can be connected to a SIMATIC PCS 7 automation system (controller) via up to 4 internal interfaces in the CPU and up to 10 additional CP 443-5 Extended communications processors.

If a module slot provided in the CPU for the PROFIBUS connection is still vacant, an IF 964-DP interface module is required in addition. When using data set routing with SIMATIC PDM, use of the CP 443-5 Extended communications processor is essential for the PROFIBUS connection.

Benefits

Advantages of the CP 443-5 Extended communications module:

- Compact design; 9-contact Sub-D socket for connection to PROFIBUS DP
- Simple installation
Can be plugged into AS rack slot; connection to the other S7-400 modules via backplane bus
- Operation without fan; backup battery or memory submodule are not required

Selection and Ordering Data

Order No.

CP 443-5 Extended

Communications processor for connection of SIMATIC S7-400 to PROFIBUS as DP master or for S7 communication, for data set routing of SIMATIC PDM

6GK7 443-5DX04-0XE0

IF 964-DP

Interface module for connection of another PROFIBUS DP line, for plugging into a free DP module slot of the CPU

6ES7 964-2AA04-0AB0

Communication

PROFIBUS DP

Y-Link

Overview



The Y-link is a bus coupler for transition from a redundant PROFIBUS DP master system to a single-channel PROFIBUS DP master system. It can be used for connecting devices with only one PROFIBUS DP interface to the redundant PROFIBUS DP master system AS 414H/ AS 417H.

Selection and Ordering Data

Order No.

Y-Link

For connection of devices with only one PROFIBUS DP interface to a fault-tolerant automation system, comprising:

- 2 IM 153-2 High Feature interface modules
- 1 Y-coupler
- 1 BM IM 157 bus module (IM/IM)
- 1 BM Y-coupler bus module

6ES7 197-1LA11-0XA0 B)

PS 307 load power supply

Including connection assembly; 120/230 V AC; 24 V DC

- 2 A; 50 mm wide
- 5 A; 80 mm wide
- 5 A, extended temperature range; 80 mm wide
- 10 A, 200 mm wide

6ES7 307-1BA00-0AA0
6ES7 307-1EA00-0AA0
6ES7 307-1EA80-0AA0
6ES7 307-1KA01-0AA0

PS 305 load power supply

24/48/60/110 V DC; 24 V DC

- 2 A, extended temperature range; 80 mm wide

6ES7 305-1BA80-0AA0

B) Subject to export regulations: AL: N, ECCN: EAR99H

Design

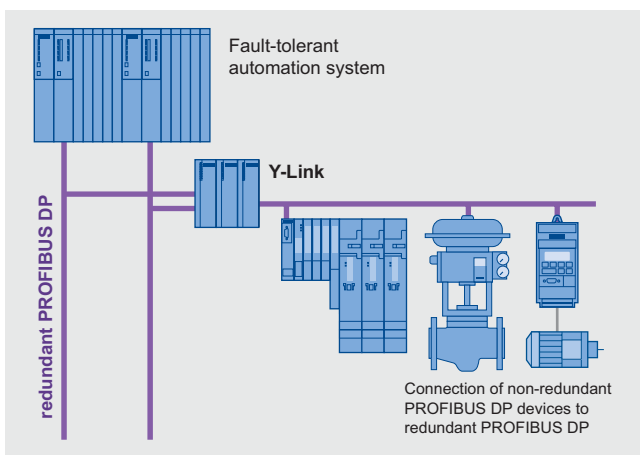

The Y-link comprises:

- Two IM 153-2 High Feature interface modules for extended temperature range
- One Y-coupler incl. RS 485 repeater
- One IM 157 (IM/IM) bus module for two IM 153-2 High Feature modules, for extended temperature range
- One BM Y-coupler bus module

Evaluation of the Y-Link diagnostics (and hence indirectly of the connected DP standard slaves) is supported by driver blocks.

It is recommendable to have a redundant -24 V DC supply for the Y-Link, e.g. with two PS 307/PS 305 load power supplies.

Overview



Direct interfacing of the devices in the field, especially in the hazardous area, together with the information content of the communication, are of significant importance in the process industry. PROFIBUS PA, which permits both digital data transmission and the power supply on a two-wire line with the intrinsically-safe MBP transmission technology (Manchester Coded; Bus Powered) is tailored to these requirements. It is optimally suitable for direct integration of the pneumatic actuators, solenoid valves and sensors positioned in operating environments up to Ex zone 1 or 0 into the process control system.

The typical response time of a transmitter of approx. 10 ms indicates that short cycle times can be achieved with the PROFIBUS PA even in the case of a segment configuration with up to 31 devices. Practically all typical applications of the process industry can be implemented - both with small or large plant distances. Bidirectional communication and high information content allow enhanced diagnostics for fast and exact fault detection and elimination. The standardized communications services guarantee interoperability and replaceability between multi-vendor field devices and remote parameterization of the field devices during operation.

The PROFIsafe profile allows seamless integration of safety communication into the PROFIBUS PA. You need not configure a separate safety bus for your safety-related applications. The PROFIBUS PA with the PROFIsafe profile is incorporated in "Safety Integrated for Process Automation". This comprehensive range of products and services from Siemens for failsafe, fault-tolerant applications in the process industry offers you attractive and cost-effective alternatives to separate safety systems.

You can define the degree of redundancy separately for the controller, fieldbus and I/O levels of your plant depending on the automation task and the derived safety requirements, and match them to the field instrumentation (Flexible Modular Redundancy, FMR). You can find an overview of the redundant architectures of PROFIBUS PA under "Design".

The PROFIBUS PA is based on electrical transmission components. A shielded two-wire cable is used for digital data transmission and for the power supply. With line, tree and ring topologies, it is possible to configure networks with spur lines up to 120 m and bus segments up to approx. 1.9 km for operating environments up to Ex zone 2. With bus segments for hazardous areas in line with zone 1, the max. possible length per spur line is reduced to 30 m and per bus segment to 1 km. The line lengths actually achievable in practice depend on the number of PA devices and their current consumption. Bus segments are terminated either automatically (with active field distributors AFD in the case of ring topologies) or with the passive terminating element for PROFIBUS PA (SplitConnect terminator).

The DP/PA Link is preferred for the gateway from PROFIBUS PA to PROFIBUS DP. When using the DP/PA Link, the transmission rate on the PROFIBUS DP is independent of the subordinate PROFIBUS PA segments. The configuration of the DP/PA Link depends on the operating environment (Ex zone) or the selected redundancy architecture. The types of coupler described in the Section "Gateways - DP/PA link and DP/PA coupler" are used for the configuration. With a small amount of data (small quantity framework) and low timing requirements, the DP/PA coupler can also be operated in stand-alone mode as a gateway.

Benefits

Advantages provided by distributed field automation with application of the PROFIBUS PA profile included low hardware overhead, cost-effective engineering, increased operational safety and problem-free maintenance. These advantages are underlined by the following features:

- Modularity and uniformity from the sensor up to the control level permit new plant concepts
- Implementation of intrinsically-safe applications through use of the fieldbus in hazardous areas
- Flexible Modular Redundancy (FMR) from the automation system (controller) down to the PROFIBUS PA field device with redundant architectures for environments up to Ex zone 2 (ring and line topologies with coupler redundancy)
- Safety-related and fault-tolerant applications with low device and cabling overheads
- Reduced configuration costs through simple, central engineering of the field devices (PROFIBUS PA and HART with SIMATIC PDM, also cross-vendor)
- Simple installation using two wire cable for common power supply and data transmission
- Reduced commissioning costs through simplified loop check
- Low servicing costs thanks to simple wiring and comprehensive diagnostics facilities

Communication

PROFIBUS PA

Introduction

Design

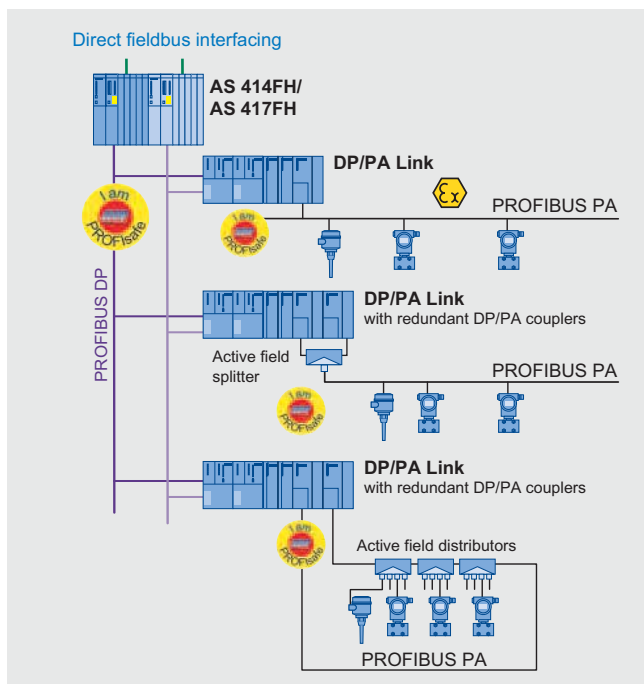

Basic PROFIBUS PA design versions when using the DP/PA link as the router

Basic PROFIBUS PA design versions are presented at this point. In these configuration examples, DP/PA links are used in each case as the DP/PA router. Up to 5 DP/PA couplers can be operated in a DP/PA link. Mixed configurations (e.g. line and ring on one link) are also possible. The DP/PA router can also be implemented with a DP/PA coupler. In this case, the PROFIBUS DP connection is directly on the coupler instead of per interface module.

Linear architecture with single coupler

In this design version, each PROFIBUS PA line is linked with one DP/PA coupler of a DP/PA router. Depending on the operating environment, you can use either the FDC 157-0 DP/PA coupler (up to Ex zone 2) or the Ex [i] DP/PA coupler (up to Ex zone 1). The DP/PA router can be connected to a single or redundant PROFIBUS DP.

Linear architecture with redundant couplers

The active field splitter (AFS) connects a PROFIBUS PA line with two FDC 157-0 DP/PA couplers of a DP/PA router. This router is operable on a single or redundant PROFIBUS DP. The AFS switches the PROFIBUS PA line to the active one of the two redundant couplers.

Flexible Modular Redundancy is possible at the device level by grouping individual devices in different PROFIBUS PA lines. Only one PROFIBUS PA line can be configured with coupler redundancy on each DP/PA router. A PROFIBUS PA ring cannot then be operated on this router.

Ring architecture

Active field distributors (AFD) integrate PROFIBUS PA field devices via 4 short-circuit proof spur line connections into a PROFIBUS PA ring with automatic bus termination. The PROFIBUS PA ring is connected to two FDC 157-0 DP/PA couplers of a DP/PA router. The DP/PA router can be operated on a single or redundant PROFIBUS DP. Up to 8 AFDs can be configured per ring.

Flexible Modular Redundancy is possible at the device level by grouping individual devices on different AFDs. Only one ring can be configured on each DP/PA router. A PROFIBUS PA line with coupler redundancy cannot then be operated on this router.

The following limits must be observed for a PROFIBUS PA ring with respect to the configuration with PROFIBUS PA devices:

- Max. 31 PROFIBUS-PA devices
- Max. current consumption of all PROFIBUS-PA devices: 1 A

Particular advantages of the ring architecture:

- High availability
- Transparent redundancy management of the intelligent FDC 157-0 DP/PA couplers for the higher-level system
- Active bus terminations for automatic bus termination in the FDC 157-0 DP/PA couplers and the AFDs permit:
 - Automatic, bumpless isolation of defective sub-segments in event of short-circuit or wire breakage
 - Changing of the ring configuration and the instrumentation during operation, including addition or removal of ring segments
- Safety-related and fault-tolerant applications with low device and cabling overheads

Technical specifications

PROFIBUS PA	
Data transmission	MBP
Transmission rate	31.25 Mbit/s
Cable	2-wire shielded
Type of protection	EEx(ia/ib)
Topology	Line, tree, ring
PA devices per segment/coupler	31
PA devices per DP/PA link	64
Cable length per segment dependent on transmission rate	1900 m: standard 1900 m: EEx(ib) 1000 m: EEx(ia)

Overview



To create a smooth network transition between PROFIBUS DP and PROFIBUS PA, the SIMATIC product range offers two versions: the DP/PA coupler and the DP/PA link.

The following criteria can be applied when choosing the network transition:

- DP/PA coupler:
For small quantity frameworks (volumes of data) and low timing requirements; limiting of data transfer rate on the PROFIBUS DP to 45.45 kbit/s
- DP/PA link:
For large number of stations and high cycle time requirements; data transfer rate on the PROFIBUS DP up to 12 Mbit/s

Application

The two DP/PA routers are based on two versions of the DP/PA coupler:

- Ex [i] DP/PA coupler (max. output current 110 mA) for implementation of PROFIBUS PA networks with a line or tree topology in environments up to Ex zone 1, not for redundant architectures (coupler redundancy, ring)
- FDC 157-0 DP/PA coupler (max. output current 1000 mA) for implementation of PROFIBUS PA networks with a line, tree or ring topology in environments up to Ex zone 2; can be used for the redundant architectures "Ring" and "Coupler redundancy"

DP/PA couplers are also integral components of the DP/PA link (see design). The DP/PA link connects PROFIBUS DP and PROFIBUS PA together, and decouples the transmission rates. In contrast to the DP/PA coupler which limits the data transmission rate on the PROFIBUS DP to 45.45 kbit/s, the DP/PA link does not influence the performance of the PROFIBUS DP.

The DP/PA link functions as a slave on the PROFIBUS DP and as a master on the PROFIBUS PA. From the viewpoint of the host PROFIBUS DP master, the DP/PA link is a modular slave whose modules are the devices connected on the PROFIBUS PA. Addressing of these devices is carried out indirectly via the DP/PA link which itself only requires one node address. The host PROFIBUS master can scan devices connected to the DP/PA link all at once.

If the router is a DP/PA coupler, the nodes on the PROFIBUS PA are directly addressed by the PROFIBUS DP master (controller). The DP/PA coupler is an electrical node, but is transparent for communication between the master and PA field devices; it therefore does not require setting of parameters or addresses (exception: FDC 157-0 DP/PA coupler used as PROFIBUS diagnostics slave).

PROFIBUS diagnostics with FDC 157-0 DP/PA coupler, configured as PROFIBUS diagnostics slave

FDC 157-0 DP/PA couplers configured as PROFIBUS diagnostics slaves supply extensive diagnostic and status information via PROFIBUS for swift location and clearance of faults:

- I&M data (Identification & Maintenance)
- Current and voltage values on the main cable
- Redundancy status
- Wire breakage
- Short-circuit
- Signal level

For this purpose, each FDC 157-0 DP/PA coupler requires its own PROFIBUS address. This applies independent of use in a DP/PA link or as a DP/PA router.

The DP/PA link and DP/PA couplers as DP/PA routers can be mounted on an S7-300 profile rail. They are operated with 24 V DC, and can be installed in environments up to Ex zone 2 with extended temperature range.

Communication

PROFIBUS PA

Routers: DP/PA link and DP/PA coupler

Design

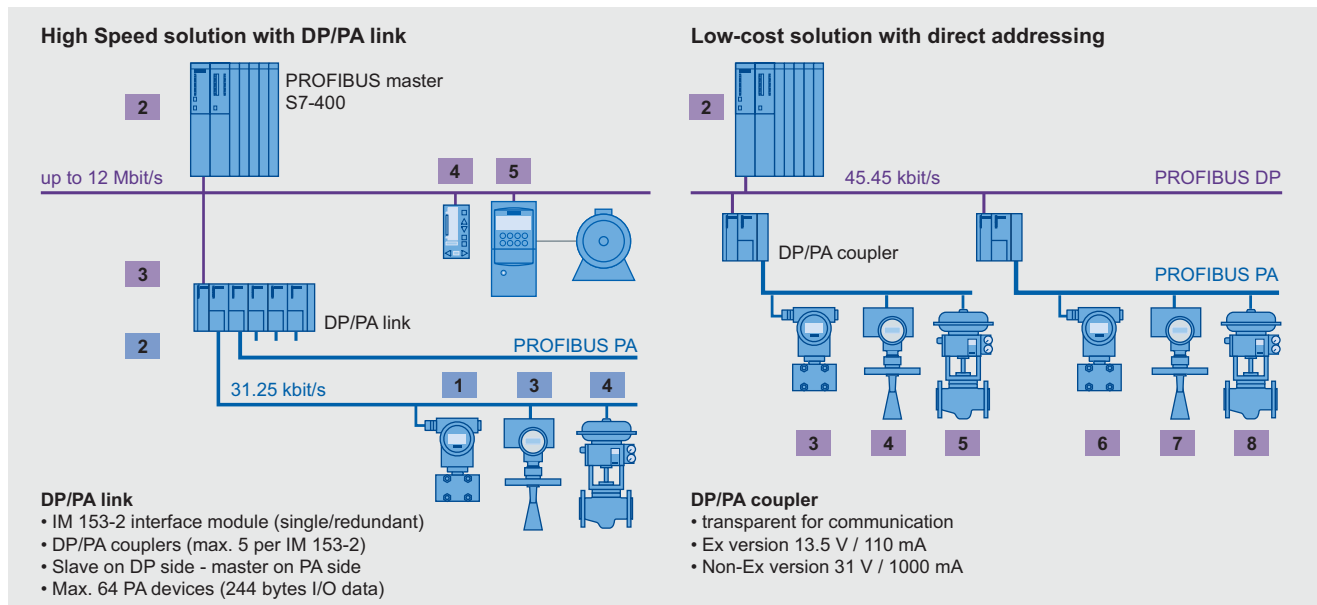

Configuration examples with DP/PA link and DP/PA coupler

DP/PA link:

The DP/PA link is a modular combination consisting of the IM 153-2 High Feature PROFIBUS DP interface module (with optional redundancy) and up to 5 DP/PA couplers (Ex [i] or FDC 157-0) packaged in an S7-300 design.

All components of the DP/PA link are interconnected through the S7 backplane bus. Use of active bus modules on the backplane allows hot swapping of individual modules and redundancy of the IM 153-2 High Feature PROFIBUS DP interface modules and the FDC 157-0 DP/PA coupler.

The PS 307 or PS 305 load power supply can be used for the 24 V DC. With a redundant IM 153-2 High Feature interface module for PROFIBUS DP, it is also recommendable to have a redundant 24 V DC supply, e.g. with two PS 307/PS 305 load power supplies.

The PROFIBUS PA lines/rings designed with the DP/PA couplers are physically separated as regards current input, but form one bus system in communication terms. A PROFIBUS PA ring or a PROFIBUS PA line with coupler redundancy can be operated on each DP/PA link. Further PROFIBUS PA lines can be operated on this DP/PA link using individual couplers. The FDC 157-0 DP/PA couplers provided for the ring coupling or coupler redundancy must always be located at the right-hand end of a sequence of up to 5 couplers.

The following basic components are available to configure the DP/PA link:

- IM 153-2 High Feature interface module for extended temperature range
- DP/PA coupler (Ex [i] and FDC 157-0)
- Components for redundant design and for hot swapping
 - DIN rail for hot swapping (as an alternative to the standard DIN rail)
 - BM PS/IM for 1 load power supply and 1 IM 153-2 High Feature module
 - IM/IM (IM 157) bus module for two IM 153-2 High Feature modules, for redundant and non-redundant design and for extended temperature range
 - DP/PA bus module for one DP/PA coupler Ex [i] or FDC 157-0, for extended temperature range (up to 5 DP/PA couplers possible per DP/PA link)
 - DP/PA but module for 2 DP/PA coupler FDC 157-0, for extended temperature range

Additive option:

- PS 307 load power supply for 120/230 V AC; 24 V DC, version in 2, 5 or 10 A, or
PS 305 load power supply for 24/48/60/110 V DC; 24 V DC, 2 A

Technical specifications

DP/PA coupler

Connection for PROFIBUS PA		
<ul style="list-style-type: none"> DP/PA coupler Ex [i] DP/PA coupler FDC 157-0 	2 terminals of a 4-pole screw-type terminal, integral terminating resistor	
Connection for PROFIBUS DP	9-pin Sub-D plug, contact assignment as described in IEC 61158/EN 50170	
Backplane bus	Connection through S7 backplane bus connector (only necessary for DP/PA link); non-floating The active BM DP/PA bus modules are required for the hot swapping function	
Diagnostic displays	<ul style="list-style-type: none"> DP/PA coupler Ex [i] and DP/PA coupler FDC 157-0 Additive with DP/PA coupler FDC 157-0 	Bus activity "DP" (yellow) Bus activity "PA" (yellow) 24 V DC "ON" (green) Group fault "SF" (red) Bus fault "BF" (rot) DP/PA coupler activated, feeding/transmitting "ACT" (yellow), only with PA redundancy
Power supply	24 V DC (20.4 V ... 28.8 V)	
Current consumption	<ul style="list-style-type: none"> DP/PA coupler Ex [i] DP/PA coupler FDC 157-0 	Max. 400 mA Max. 2300 mA
Voltage at coupler output	<ul style="list-style-type: none"> DP/PA coupler Ex [i] DP/PA coupler FDC 157-0 	13 V ... 14 V DC 31 ± 1 V DC
Max. current at coupler output	<ul style="list-style-type: none"> DP/PA coupler Ex [i] DP/PA coupler FDC 157-0 	110 mA 1 A (up to 50 °C), 0.8 A (up to 60 °C)
Power loss	<ul style="list-style-type: none"> DP/PA coupler Ex [i] DP/PA coupler FDC 157-0 	Approx. 7 W Approx. 13.4 W
Operating temperature	<ul style="list-style-type: none"> DP/PA coupler Ex [i] and DP/PA coupler FDC 157-0 	-25 ... +60 °C (horizontal installation) -25 ... +40 °C (vertical installation)
Dimensions (W x H x D) in mm	80 x 125 x 130	
Weight	Approx. 515 g	

IM 153-2 High Feature (for extended temperature range)

Function	Linking of PROFIBUS DP (9.6 kbit/s to 12 Mbit/s, slave functionality) and PROFIBUS PA with support of the "Configuration in Run" function The DP/PA link function is only implemented by extending the IM 153-2 High Feature with one or more DP/PA couplers. Stand-alone operation of the IM 153-2 High Feature is not possible. 1 Y coupler, up to 5 DP/PA couplers or up to 64 slaves can be connected Isolation from the higher-level DP master system	
Interfaces	<ul style="list-style-type: none"> Connection for PROFIBUS DP Backplane bus 	9-pin Sub-D plug, contact assignment as described in IEC 61158/EN 50170, Vol. 2 Connection through S7 backplane bus connector, non-floating Bus modules and profile rails for hot swapping are required for the hot swapping function and for a redundant PROFIBUS DP interface module.
Diagnostic displays	<ul style="list-style-type: none"> DP/PA coupler Ex [i] and DP/PA coupler FDC 157-0 	Group fault "SF" (red) Bus fault DP "BF 1" (red) Bus fault PA "BF 2" (red) IM active "ACT" (yellow) 24 V DC "ON" (green)
Power supply	24 V DC	
Current consumption	Max. 100 mA (in DP/PA link) Max. 200 mA (in Y-link)	
Power loss	Approx. 2 W (in DP/PA link) Approx. 4 W (in Y-link)	
Voltage failure bridging	20 ms	
Mechanical design of power supply	4-pin screw terminal, short-circuiting link between PE and M24; the short-circuiting link must be removed for floating operation (independent of this, the DP interface is always floating)	
Permissible operating temperature	-25 ... +60 °C (horizontal installation) -25 ... +40 °C (vertical installation)	
Dimensions (W x H x D) in mm	40 x 125 x 130	
Weight	Approx. 350 g	

Communication

PROFIBUS PA

Routers: DP/PA link and DP/PA coupler

Selection and Ordering Data	Order No.
DP/PA coupler For transition from RS 485 to MBP	
<ul style="list-style-type: none"> DP/PA coupler Ex [i] 6ES7 157-0AD82-0XA0 DP/PA coupler FDC 157-0, redundant design possible 6ES7 157-0AC83-0XA0 B) 	
IM 153-2 High Feature Interface module for DP/PA Link and Y-Link; for extended temperature range	6ES7 153-2BA82-0XB0 B)
Accessories	
PS 307 load power supply Including connection assembly; 120/230 V AC; 24 V DC	
<ul style="list-style-type: none"> 2 A; 50 mm wide 6ES7 307-1BA00-0AA0 5 A; 80 mm wide 6ES7 307-1EA00-0AA0 5 A, extended temperature range; 80 mm wide 6ES7 307-1EA80-0AA0 10 A, 200 mm wide 6ES7 307-1KA01-0AA0 	
PS 305 load power supply 24/48/60/110 V DC; 24 V DC	
<ul style="list-style-type: none"> 2 A, extended temperature range; 80 mm wide 6ES7 305-1BA80-0AA0 	
Standard profile rails (without hot swapping function)	
<ul style="list-style-type: none"> 482 mm wide (19 inches) 6ES7 390-1AE80-0AA0 530 mm wide 6ES7 390-1AF30-0AA0 	

Selection and Ordering Data	Order No.
Components for hot swapping and for redundant design	
Active bus modules for hot swapping	
<ul style="list-style-type: none"> BM PS/IM For one load power supply and one IM 153-2 High Feature module 6ES7 195-7HA00-0XA0 BM IM 157 For two IM 153-2 High Feature modules, for redundant and non-redundant configuration, for extended temperature range, for hot swapping function, permissible operating temperature -25...+60 °C 6ES7 195-7HD80-0XA0 BM DP/PA For one DP/PA coupler Ex [i] or FDC 157-0, for extended temperature range, for hot swapping function, permissible operating temperature -25 to +60 °C 6ES7 195-7HF80-0XA0 BM DP/PA For two DP/PA couplers FDC 157-0, for extended temperature range, for hot swapping function, permissible operating temperature -25 to +60 °C 6ES7 195-7HG80-0XA0 B) 	
Profile rail for hot swapping For max. 5 active bus modules	
<ul style="list-style-type: none"> 482 mm wide (19 inches) 6ES7 195-1GA00-0XA0 530 mm wide 6ES7 195-1GF30-0XA0 620 mm wide 6ES7 195-1GG30-0XA0 	

B) Subject to export regulations: AL: N, ECCN: EAR99H

Active field distributor AFD and active field splitter AFS

Overview



Active field distributor AFD

An active field distributor (AFD) can integrate up to 4 PROFIBUS PA field devices via short-circuit proof spur line connections into a PROFIBUS PA ring with automatic bus termination. The PROFIBUS PA ring is connected to two FDC 157-0 DP/PA couplers of a DP/PA router. Up to 8 AFDs and up to 31 PROFIBUS PA devices can be configured per ring. The number of PROFIBUS PA devices is additionally limited by the max. current consumption of 1 A for all devices.

An AFD can be replaced during operation. The function of the PROFIBUS PA devices on the other AFDs is not influenced by this.

Active field splitter AFS

The active field splitter (AFS) connects a PROFIBUS PA line with two redundant FDC 157-0 DP/PA couplers of a DP/PA router. The AFS switches the PROFIBUS PA line to the active one of the two redundant couplers.

Up to 31 PROFIBUS PA devices can be connected on the PROFIBUS PA line. This number is additionally limited by the max. current consumption of 1 A for all devices.

Technical specifications

Active field distributor AFD and active field splitter AFS

Active field distributor AFD

Connection of PROFIBUS PA field devices	<ul style="list-style-type: none"> • Max. 4 per AFD • Max. 31 per ring • Operating environment up to zone 2 or 22 • Max. current consumption of all devices 1 A
Current I _{max.} per spur line X1 to X4	60 mA
Power supply	16 V DC (16 ... 32 V)
Current consumption	Approx. 20 mA
Power loss	Approx. 600 mW
Output voltage for PA section	31 V ± 1 V DC
Voltage failure bridging	5 ms
Output current for PA section (for dimensioning of device configuration)	1 A

Active field distributor AFD and active field splitter AFS

Diagnostic displays	Status PA main line PA1, PA2 (green) Fault PA main line PA1, PA2 (red) Status/fault PA spur line X1 to X4 (green)
Permissible operating temperature	-25 ... +70 °C
Dimensions (W x H x D) in mm	120 x 57 x 80
Weight	Approx. 700 g
Active field splitter AFS	
Connection of PROFIBUS PA field devices	<ul style="list-style-type: none"> • Max. 31 per line • Operating environment up to zone 2 or 22 • Max. current consumption of all devices 1 A
Power supply	16 V DC (16 ... 32 V)
Current consumption	Approx. 20 mA
Power loss	Approx. 600 mW
Output voltage for PA section	31 V ± 1 V DC
Voltage failure bridging	5 ms
Output current for PA section (for dimensioning of device configuration)	1 A
Diagnostic displays	Status PA main line PA1, PA2 (green) Fault PA main line PA1, PA2 (red)
Permissible operating temperature	-25 ... +70 °C
Dimensions (W x H x D) in mm	120 x 57 x 80
Weight	Approx. 700 g

Selection and Ordering Data

Order No.

Active field distributor AFD with 4 short-circuit-proof spur line connections for integration of field devices	6ES7 157-0AF81-0XA0 B)
Active field splitter AFS for connecting a PROFIBUS PA line to 2 redundant FDC 157-0 DP/PA couplers; automatic switchover to the active coupler	6ES7 157-0AF82-0XA0 B)
Profile rail adapter for an active field distributor AFD or active field splitter AFS, optional	6ES7 157-0AF83-0XA0

B) Subject to export regulations: AL: N, ECCN: EAR99H

Communication

PROFIBUS PA

FastConnect/SpliTConnect

Overview

PROFIBUS FC process cables, color-coded for the various applications (Ex, non-Ex area) are available for designing field bus networks in accordance with IEC 61158-2 (e.g. PROFIBUS PA).

The FastConnect stripping tool can be used to strip the FC process cable for PROFIBUS PA to the correct length for casing and shield.

Design

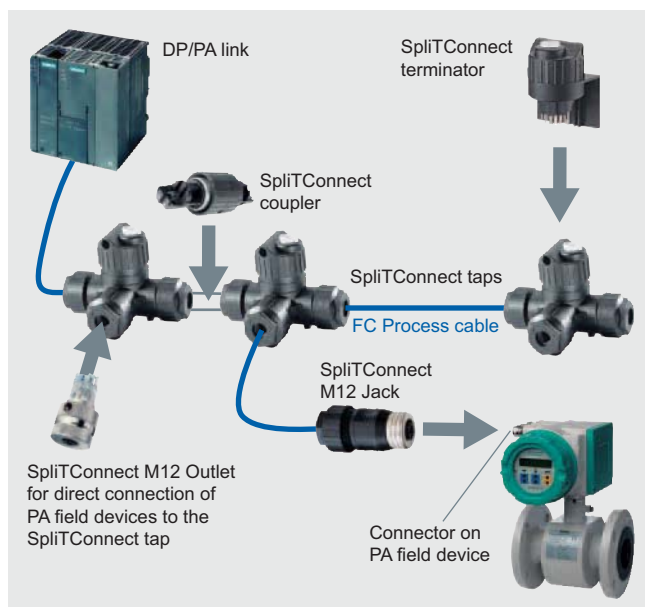

SpliTConnect

The SpliTConnect Tap enables the design of fieldbus segments according to IEC 61158-2 with field device connection points.

The SpliTConnect Coupler can be used to construct a PROFIBUS PA hub by connecting SpliTConnect Taps in series.

By replacing the contacting screw by the SpliTConnect Terminator, the SpliTConnect Tap can be used as a bus terminating element.

Terminal equipment can be connected directly through the FC process cable. Using the SpliTConnect M12 Outlet, PA field devices can also be connected to the SpliTConnect Tap by an M12 connection. The SpliTConnect M12 Jack is a connecting element between an FC process cable and an M12 connector on the PROFIBUS PA field device. For details on SpliTConnect network components, see Catalog IK PI.

Selection and Ordering Data

Order No.

FC Process Cable

2-core, shielded

- Blue for Ex applications
- Black for non-Ex applications

6XV1 830-5EH10**6XV1 830-5FH10**

Sold by the meter:
Max. delivery unit 1000 m,
minimum ordering quantity 20 m

PROFIBUS FastConnect Stripping Tool

Stripping tool for rapid stripping of insulation from PROFIBUS FastConnect bus cables

6GK1 905-6AA00

PROFIBUS FastConnect Blade Cassettes

Spare blade cassettes for the PROFIBUS FastConnect stripping tool, 5 pcs

6GK1 905-6AB00

SpliTConnect Tap

For design of PROFIBUS PA segments and connection of PA field devices, insulation displacement system, IP67, 10 pcs

6GK1 905-0AA00

SpliTConnect M12 Outlet

Replacement element for direct connection of PA field devices to the SpliTConnect Tap, 5 pcs

6GK1 905-0AB10

SpliTConnect Coupler

Connection element for cascading SpliTConnect Taps in order to configure star points, 10 pcs

6GK1 905-0AC00

SpliTConnect Terminator

For termination of PROFIBUS PA segments, 5 pcs

- Terminator (Ex); use possible in hazardous area

6GK1 905-0AD00

- Terminator (non-Ex); use not possible in hazardous area

6GK1 905-0AE00

SpliTConnect M12 Jack

Connection element between FC process cable and M12 plug on the PROFIBUS PA field device, 5 pcs

6GK1 905-0AF00

Overview



The actuator-sensor interface (AS-Interface) is a multi-vendor networking system for simple - usually binary - actuators and sensors in the lowest field area. AS-Interface enables a wiring loom with parallel wiring to be replaced by a simple two-wire cable shared by all sensors or actuators.

The AS-Interface works by the master-slave principle. Sensors/actuators connected through the AS-Interface cable are controlled by the master as slaves.

Note:

AS-Interface is integrated in SIMATIC pcs 7 as a *subordinate* bus. Consequently, this bus does not offer the full functionality of SIMATIC PCS 7; this applies in particular to diagnostics functions. Further information, see Catalog IK PI.

Design



System components

The basic components of a system installation are:

- CP 343-2 AS-Interface master module for ET 200M *or/and* DP/AS-Interface link for connection of an AS-Interface line to PROFIBUS DP
- AS-Interface shaped cable (use of round cable also possible if preferred)
- Modules for connecting standard sensors/actuators
- Power supply unit for powering the slaves
- Actuators and sensors with an integrated slave ASIC
- Address programming device for setting the slave address

Selection and Ordering Data

Order No.

CP 343-2 Communications processor for connection of SIMATIC S7-300 and ET 200M to AS-Interface, without front connector	6GK7 343-2AH00-0XA0
Front Connector 20-pin, with screw contacts	6ES7 392-1AJ00-0AA0
CP 343-2 Manual Including software and examples <ul style="list-style-type: none"> • German • English • French • Italian 	6GK7 343-2AH00-8AA0 6GK7 343-2AH00-8BA0 6GK7 343-2AH00-8CA0 6GK7 343-2AH00-8EA0
DP/AS-Interface Link 20E PROFIBUS DP/ AS-Interface gateway, degree of protection IP 20	6GK1 415-2AA01
Manual for DP/AS-Interface Link 20E Paper version incl. type and GSD files <ul style="list-style-type: none"> • German • English • French • Spanish • Italian 	6GK1 971-2DS01-0AA0 6GK1 971-2DS01-0AA1 6GK1 971-2DS01-0AA2 6GK1 971-2DS01-0AA3 6GK1 971-2DS01-0AA4

Communication

Other communication

Modbus

Overview



Modbus is connected to PROFIBUS DP using an ET 200M with a CP 341 communications processor. The latter enables the fast and efficient exchange of data through point-to-point coupling.

The CP 341 communications module is available in 3 versions with different transmission physics:

- RS 232C (V.24)
- 20 mA (TTY)
- RS 422/RS 485 (X.27)

The MODBUS Master or MODBUS Slave loadable drivers are needed for the Modbus coupling.

Selection and Ordering Data

Order No.

CP 341 communications processor with one RS 232 C (V.24) interface	6ES7 341-1AH01-0AE0
--	----------------------------

RS 232 connecting cable for linking to SIMATIC S7	
• 5 m	6ES7 902-1AB00-0AA0
• 10 m	6ES7 902-1AC00-0AA0
• 15 m	6ES7 902-1AD00-0AA0

CP 341 communications processor with one 20 mA (TTY) interface	6ES7 341-1BH01-0AE0
--	----------------------------

20 mA (TTY) connecting cable for linking to SIMATIC S7	
• 5 m	6ES7 902-2AB00-0AA0
• 10 m	6ES7 902-2AC00-0AA0
• 50 m	6ES7 902-2AG00-0AA0

CP 341 communications processor with one RS 422/485 (X.27) interface	6ES7 341-1CH01-0AE0
--	----------------------------

RS 422/485 connecting cable for linking to SIMATIC S7	
• 5 m	6ES7 902-3AB00-0AA0
• 10 m	6ES7 902-3AC00-0AA0
• 50 m	6ES7 902-3AG00-0AA0

Loadable drivers for CP 341

MODBUS master (RTU format)	
• Single license	6ES7 870-1AA01-0YA0
• Single license, without software or documentation	6ES7 870-1AA01-0YA1
MODBUS slave (RTU format)	
• Single license	6ES7 870-1AB01-0YA0
• Single license, without software or documentation	6ES7 870-1AB01-0YA1

Automation systems



10/2	Introduction
10/4	Microbox automation system
10/7	Standard automation systems
10/15	Fault-tolerant automation systems
10/24	Safety-related automation systems

Automation systems

Introduction

Overview

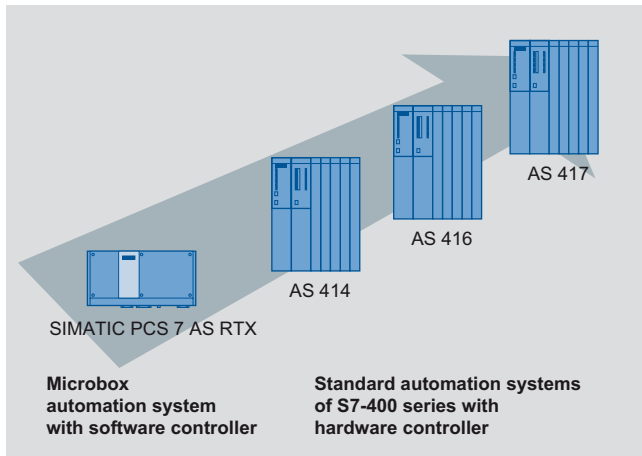

Scalable automation systems, overview

The SIMATIC PCS 7 process control system offers a wide range of automation systems whose performances are finely matched to one another within wide limits. This results in fine scaling of the automation performance over the complete performance range.

The automation systems offered can be differentiated according to various criteria. In accordance with the design, they are categorized as:

- Microbox automation system with software controller
- Modular automation systems of the S7-400 range with hardware controller

Application

Microbox automation system

The SIMATIC PCS 7 AS RTX Microbox automation system represents the starter system in the lower performance range of SIMATIC PCS 7. As a result of its exceptional physical properties and small dimensions, it is particularly suitable for use at plant level in industrial applications.

Modular automation systems of the S7-400 range

In these "Automation system bundles", selected components of the SIMATIC S7-400 are combined together.

The following characteristics make the SIMATIC S7-400 predestined for use as a SIMATIC PCS 7 automation system:

- Modular design without fans
- High expansion capability and ruggedness
- Single or redundant design
- Comprehensive communication facilities
- Integral system functions
- Integrable safety functions (Safety Integrated)
- Simple linking of central or distributed I/O

In accordance with their functionalities, the modular automation systems of the S7-400 range can be classified into:

- Standard automation systems
- Fault-tolerant automation systems
- Safety-related automation systems

Various automation systems are available with a price/performance ratio which can be tailored to your system requirements. The CPU of the automation systems is already equipped as standard with an onboard PROFIBUS DP fieldbus connection. Depending on the type of CPU, 1 or 2 further PROFIBUS DP interfaces are possible using additional IF 964-DP interface modules. PROFIBUS communication modules can be additionally fitted if required.

Design

Microbox automation system

The compact and rugged automation system based on the SIMATIC Microbox PC 427B has been designed for maintenance-free 24-hour continuous operation at ambient temperatures up to 55 °C. Since there are no fans or rotating storage media, it is resistant to vibration and shock.

The Windows XP Embedded operating system, the WinAC RTX controller software, and the SIMATIC PC DiagMonitor diagnostics software are preinstalled on the supplied 2-GB Compact-Flash card. The scope of delivery also includes an AS runtime license for 250 POs.

Modular automation systems of the S7-400 range

The SIMATIC PCS 7 automation systems of the S7-400 range are delivered as preassembled and tested all-in-one systems (AS bundles) at no extra charge. Each of these AS bundles is already combined with a SIMATIC PCS 7 AS Runtime license for 100 process objects (PO).

The configuration of the AS bundles and their Order Nos. can be individually combined by selecting preconfigured ordering units. System-specific ordering configurations are available for this purpose in the Sections "Standard automation systems", "Fault-tolerant automation systems" and "Safety-related automation systems". In order to facilitate selection of preferred configurations, these are additionally listed with their complete Order Nos.

As an alternative to this catalog for ordering the AS bundles, a configurator offered in the catalog & online ordering system "A&D Mall" (www.siemens.com/automation/mall) can also be used.

Depending on the configuration as Single Station or Redundant Station, an AS bundle is equipped with the following components:

- 1 or 2 racks with 9 or 18 slots
- 1 or 2 SIMATIC S7-400 CPUs
- 1, 2 or 4 PS 405 (24 V DC) or PS 407 (120/230 V AC/DC) power supplies, without backup batteries in each case
- 1 or 2 x RAMs from 768 KB to 30 MB
- 1 or 2 memory cards with 2 to 16 MB RAM
- 1, 2 or 4 interface modules for Industrial Ethernet plant bus (via CP or integrated in CPU)
- Additive PROFIBUS communications processors (by means of configurator up to 4 per Single Station, up to 8 per Redundant Station)
- 4 sync modules for a range up to 10 m or 10 km and 2 fiber-optic sync cables, 1 m (longer lengths can be ordered separately)

Technical specifications

	AS 412 H/F/FH	AS 414-3IE	AS 414-3	AS 414 H/F/FH	AS 416-2	AS 416-3	AS 416-3IE	AS 417-4	AS 417 H/F/FH	AS 417-4	AS 417 H/F/FH
Memory card [in MB]	2		2/4		4	8/16	16	4			16
Analog value measurements	10		35		125	125	125	150			700
Digital value measurements	15		110		350	350	350	400			1.200
PID controls	6		35		110	110	110	130			300
Motors	10		50		125	125	125	150			450
Valves	10		50		125	125	125	150			450
SFC	0		15		40	40	40	50			200
Steps	0		150		400	400	400	500			2.000
Dosing	0		3		15	15	15	15			45
Digital inputs DI	50		220		800	800	800	850			2.000
Digital outputs DO	25		110		300	300	300	315			1.000
Analog inputs AI	20		80		250	250	250	275			800
Analog outputs AO	10		40		110	110	110	130			400
Process objects (PO)	50		283		890	890	890	995			3.145

Typical mixed quantity frameworks for SIMATIC PCS 7 S7-400 automation systems

Note:

The values quoted here are not AS-specific maximum values for the particular item but represent a typical distribution of the available total capacity of the AS during mixed operation of all the items of an assembled block.

Comparison of main memory and processing time of the S7-400 automation systems

AS type	Integrated main memory in MB	Processing time in ns
AS 414-3/414-3IE	2,8	45
AS 416-2	5,6	30
AS 416-3/416-3IE	11,2	30
AS 417-4	30	18
AS 412H/F/FH	0,768	75
AS 414H/F/FH	2,8	45
AS 417H/F/FH	30	18

Automation systems

Microbox automation system

Overview



SIMATIC PCS 7 AS RTX

With consideration of the scalable automation performance, the SIMATIC PCS 7 AS RTX Microbox automation system represents the starter system in the bottom performance range of SIMATIC PCS 7.

The compact and rugged design as well as the complete absence of fans and rotating storage media mean that it is resistant to vibration and shock, and makes it highly suitable for maintenance-free 24-hour continuous operation at ambient temperatures up to 55 °C. Particularly with small applications, it is an exceptionally good alternative to standard automation systems of S7-400 design.

Application

As a result of its exceptional physical properties and small dimensions, the SIMATIC PCS 7 AS RTX Microbox automation system is exceptionally suitable for industrial use at plant level. Just like the runtime systems (AS plus OS) and complete systems (AS plus OS and ES) based on SIMATIC PCS 7 BOX, it can be used for:

- Small production applications
- Package units
- Laboratory automation

SIMATIC PCS 7 AS RTX can also be combined with SIMATIC PCS 7 BOX or automation systems of S7-400 design within a plant.

Design

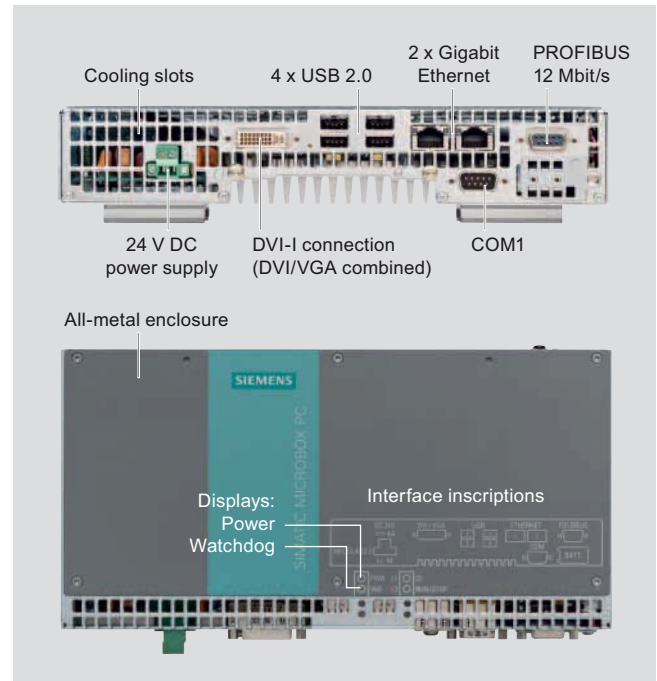

Design of the SIMATIC PCS 7 AS RTX

The SIMATIC PCS 7 AS RTX Microbox automation system is based on a SIMATIC Microbox PC 427B with a system-specific configuration. The following are preinstalled on the supplied 2-GB CompactFlash card:

- Windows XP Embedded operating system
- WinAC RTX controller software
- SIMATIC PC DiagMonitor diagnostics software



Microbox automation system with CompactFlash card

The SIMATIC PCS 7 AS RTX has an integral power supply with electrical isolation and mains buffering. Process data can be safely saved by a buffered 2-MB SRAM.

Parameterizable monitoring functions (program execution/watchdog, processor and board temperatures) as well as enhanced diagnostics/messages (e.g. operating hours counter, hard disk/system status) can be recorded via SIMATIC PC DiagMonitor and the maintenance station (PCS 7 asset management), and evaluated or signaled by LED (power/watchdog).

Microbox automation system

Two Ethernet interfaces 10/100/1000 Mbit/s (RJ45) are integrated in the SIMATIC PCS 7 AS RTX for plant bus communication with SIMATIC PCS 7 subsystems such as operator system, engineering system or maintenance station.

ET 200M, ET 200ISP and ET 200S I/O stations can be linked over a PROFIBUS DP interface to a comprehensive range of low-cost signal/function modules as well as intelligent field/process devices on the PROFIBUS PA.

The SIMATIC PCS 7 AS RTX is configured using the central engineering system of the SIMATIC PCS 7 process control system.

The engineering system also administers the AS Runtime licenses of the SIMATIC PCS 7 AS RTX. The scope of delivery of the SIMATIC PCS 7 AS RTX already includes an AS Runtime license for 250 POs. This can be expanded by further AS Runtime licenses for 100 POs. The process objects of additional AS Runtime licenses are then added to process objects which already exist.

Technical specifications

SIMATIC PCS 7 AS RTX

Design and equipment features

Design	DIN rail or wall mounting; horizontal (preferred) or vertical
Degree of protection to EN 60529 (front/rear)	IP20
CPU	
• Processor	Intel Pentium M 1.4 GHz
• Front Side Bus	400 MHz
• Second Level Cache	2 MB
Chipset	Intel Alviso 910GML
Main memory	1 GB DDR2-SDRAM (SO-DIMM modules)
Graphics	
• Graphics controller	Intel 2D/3D GMA900, integrated in chipset
• Graphics memory	Dynamic video memory 8 to 128 MB
• Resolutions/colors/frequencies	
- CRT	Up to 1600 x 1200 / 32 bit colors / 60 to 120 Hz
- DVI	Up to 1600 x 1200 / 32 bit colors
Drives	
• Flash drive	For CompactFlash card, 2 GB
• CD-ROM / DVD-RW / diskette	Connectable via USB (not included in scope of delivery)

Technical specifications

Interfaces

• PROFIBUS/MPI	12 Mbit/s (electrically isolated, CP 5611-compatible), 9-contact Sub-D socket
• Ethernet	2 x 10/100/1000 Mbit/s (RJ 45), two independent controllers
• USB	4 x USB 2.0/high-speed
• Serial	1 x COM1 (V.24), 9-contact Sub-D connector
• Parallel	-
• Graphics connection	1 x DVI-I (DVI/VGA combined): <ul style="list-style-type: none"> • DVI: digital • VGA analog
• Keyboard/mouse	Connectable via USB (not included in scope of delivery)
LED displays	<ul style="list-style-type: none"> • Power • Watchdog

Operating system / basic software

Operating system	Windows XP Embedded preinstalled on CompactFlash card (CF card) 2 GB, no activation required
System-tested SIMATIC industrial software	WinAC RTX DiagMonitor

Monitoring/diagnostics functions

Watchdog	<ul style="list-style-type: none"> • Monitoring of program execution • Restart can be parameterized following faults • Monitoring time adjustable in the software
Temperature	<ul style="list-style-type: none"> • Processor • Motherboard (via SIMATIC PC DiagMonitor and SIMATIC PCS 7 Asset Management)
Operating hours counter	(via SIMATIC PC DiagMonitor and SIMATIC PCS 7 Asset Management)

Safety

Protection class	Protection class I compliant with IEC 61140
Safety directives	EN 60950-1; UL 60950; CAN/CSA-C22.2 No. 60950-1; UL 508; CAN/CSA-C22.2 No. 142 or CAN/CSA-C22.2 No. 14-05

Noise level

Operation	< 40 dB (A) to DIN 45635-1
-----------	----------------------------

Automation systems

Microbox automation system

Technical specifications

Electromagnetic compatibility (EMC)

Emitted interference	EN 55022 Class B; FCC Class A
Immunity to conducted interference on the supply lines	± 2 kV (to IEC 61000-4-4; burst) ± 1 kV (to IEC 61000-4-5; symmetrical surge) ± 2 kV (to IEC 61000-4-5; asymmetrical surge)
Immunity to interference on signal lines	± 1 kV (to IEC 61000-4-4; burst; length < 3 m) ± 2 kV (to IEC 61000-4-4; burst; length > 3 m) ± 2 kV (to IEC 61000-4-5; surge; length > 30 m)
Immunity to static discharge	± 6 kV contact discharge (to IEC 61000-4-2) ± 8 kV air discharge (to IEC 61000-4-2)
Immunity to high-frequency irradiation	10 V/m, 80 to 1000 MHz and 1.4 to 2 GHz, 80 % AM (to IEC 61000-4-3) 1 V/m, 2 to 2.7 GHz, 80 % AM (to IEC 61000-4-3) 10 V, 10 kHz to 80 MHz, 80 % AM (to IEC 61000-4-6)
Immunity to magnetic fields	100 A/m, 50/60 Hz (to IEC 61000-4-8)

Climatic conditions

Temperature	Tested according to IEC 60068-2-1, IEC 60068-2-2, IEC 60068-2-14
• Operation	Horizontal mounting: • 0 to +50 °C • 0 to +55 °C (reduced performance) Vertical mounting: • 0 to +45 °C
• Storage/transport	-20 to +60 °C
• Gradient	Operation: max. 10 °C/h; storage: 20 °C/h, no condensation
Relative humidity	Tested according to IEC 60068-2-78, IEC 60068-2-30
• Operation	5 to 80 % at 25 °C (no condensation)
• Storage/transport	5 to 95 % at 25 °C (no condensation)

Mechanical environmental conditions

Vibrations	Tested according to IEC 60068-2-6
• Operation	10 to 58 Hz: 0.075 mm, 58 to 500 Hz: 9.8 m/s ²
• Storage/transport	5 to 9 Hz: 3.5 mm, 9 to 500 Hz: 9.8 m/s ²
Shock	Tested according to IEC 60068-2-27, IEC 60068-2-29
• Operation	150 m/s ² , 11 ms
• Storage/transport	250 m/s ² , 6 ms

Technical specifications

Approvals

CE living accommodation	
• Emitted interference	EN 61000-6-3: 2001
• Noise immunity	EN 61000-6-1: 2001
CE industrial environment	
• Emitted interference	EN 61000-6-4: 2001
• Noise immunity	EN 61000-6-2: 2005
cULus	UL 60950-1, Report E11 5352 and CAN/CSA-C22.2 No. 60950-1; UL 508 and CAN/CSA-C22.2 No. 142; CAN/CSA-C22.2 No. 14-05

Power supply (electrically isolated)

Power supply	24 V DC (20.4 to 28.8 V)
Short-term voltage dip	Max. 10 ms at 0.85 nominal supply voltage (max. 10 events per hour; recovery time min. 1 s)
Max. current consumption (at 24 V DC)	2.5 A
Power failure signaling	Power Fail signal

Dimensions and weights

Dimensions (W x H x D) in mm	262 x 133 x 47
Weight	Approx. 2 kg

Selection and Ordering Data

SIMATIC PCS 7 AS RTX
Assembled and preinstalled automation system on the basis of the SIMATIC Microbox PC 427B with Windows XP Embedded operating system, WinAC RTX controller software and SIMATIC PC DiagMonitor diagnostics software on 2-GB CompactFlash card
SIMATIC PCS 7 AS Runtime license V7.0 for 250 POs

Order No.

6ES7 654-0UC11-0XX0

Additional and expansion components

SIMATIC PCS 7 AS Runtime license (can be added to existing licenses)

7 languages (German, English, French, Italian, Spanish, Chinese, Japanese), executes with Windows XP Professional, single license for 1 installation

Type of delivery:
License key disk, certificate of license, terms and conditions

• 100 POs

6ES7 653-2BA00-0XB5

Individual components

(included in scope of delivery of SIMATIC PCS 7 AS RTX)

SIMATIC PC CompactFlash card

• 2 GB

6ES7 648-2BF01-0XF0 B)

B) Subject to export regulations: AL: N, ECCN: EAR99H

Overview



The AS 414-3 / 414-3IE, AS 416-2, AS 416-3 / 416-3IE and AS 417-4 standard automation systems are extremely robust, and feature high processing and communications performances.

Application

The AS 414-3 / 414-3IE automation systems are tailored for small applications with small quantity frameworks. They therefore fulfill the requirements for a low-cost starter solution with a modular and scalable system based on the S7-400 controller range. Larger quantity frameworks can be implemented using the AS 416-2, AS 416-3 / 416-3IE and AS 417-4 automation systems. These systems are preferred for medium-sized systems and bigger.

Automation systems with integral Industrial Ethernet interface

In addition to the AS 414-3 and AS 416-3 systems with Industrial Ethernet connection via CP 443-1, two automation systems are now offered where the Industrial Ethernet interface is integrated in the CPU. These AS 414-3IE and AS 416-3IE systems are a little cheaper than the comparable AS 414-3 and AS 416-3 systems with the same performance, but differ in their time synchronization (NTP instead of S7). When using the AS 414-3IE and AS 416-3IE systems, there are therefore two separate time synchronization circuits within the SIMATIC PCS 7 system. This results in two alternatives for users:

- Create two different servers as masters for NTP and S7 time synchronization, and tolerate any time differences which may result
- Use a SICLOCK central plant clock as the common time master

Design

The standard automation systems for SIMATIC PCS 7 are available as preassembled and tested all-in-one systems (AS bundles) at no extra charge.

Depending on the type of automation system, the RAM of these AS bundles varies as follows:

AS type	Main memory
AS 414-3 / 414-3IE	2.8 MB (1.4 MB each for program and data)
AS 416-2	5.6 MB (2.8 MB each for program and data)
AS 416-3 / 416-3IE	11.2 MB (5.6 MB each for program and data)
AS 417-4	30 MB (15 MB each for program and data)

The firmware of the standard automation systems listed in this catalog can be updated in two ways:

- Per Flash-EPROM memory card (8 MB)
- From the central engineering system via the Industrial Ethernet plant bus

Runtime licenses

The SIMATIC PCS 7 AS Runtime license for 100 POs already integrated in each AS bundle can be expanded by additional Runtime licenses for 100, 1000 or 10000 POs. The process objects of additional Runtime licenses can be added to process objects which already exist. The number and type (e.g. 100 or 1000) of additional Runtime licenses are irrelevant with regard to the implementable quantity framework. The AS Runtime licenses are administered in the engineering system of the SIMATIC PCS 7 process control system (on an engineering station or in the SIMATIC PCS 7 BOX).

Individual configuration of AS bundles

The equipment of the standard automation systems as well as their Order Nos. can be individually compiled by selecting pre-configured ordering units. System-specific ordering configurations are available for this purpose in the Section "Selection and ordering data".

The recommended preferred configurations are additionally listed with their complete Order Nos.

As an alternative to the ordering data in this catalog, the configurator offered in the catalog & online ordering system "A&D Mall" (www.siemens.com/automation/mall) can also be used to select and order the standard automation systems for SIMATIC PCS 7.

Automation systems

Standard automation systems

Selection and Ordering Data	Order No.
AS 414-3 with SIMATIC PCS 7 AS Runtime license for 100 POs CPU with 3 interfaces (MPI/DP, DP and slot for IF module) 2.8 MB RAM (1.4 MB each for program and data)	6ES7 654-
Type of delivery	
• Preassembled and tested	8
Memory card	
• Memory card 2 MB RAM (up to approx. 180 POs)	B
• Memory card 4 MB RAM (up to approx. 300 POs)	C
CPU type	
• CPU 414-3 (up to approx. 250 POs)	C
Additive IF 964-DP interface module	
• Without additive IF 964-DP	0
• 1 x IF 964-DP	1
Interface module to Industrial Ethernet plant bus	
• 1 x CP 443-1	1
Rack	
• UR2 (9 slots), aluminum	3
• UR2 (9 slots), steel	4
• UR1 (18 slots), aluminum	5
• UR1 (18 slots), steel	6
Power supply (without backup batteries)	
• 1 x PS 407, 10 A for 120/230 V AC/DC	B
• 1 x PS 407, 10 A for 120/230 V AC/DC, redundancy possible	C
• 1 x PS 407, 20 A for 120/230 V AC/DC	D
• 2 x PS 407, 10 A for 120/230 V AC/DC, redundancy possible	E
• 1 x PS 405, 10 A for 24 V DC	G
• 1 x PS 405, 10 A for 24 V DC, redundancy possible	H
• 1 x PS 405, 20 A for 24 V DC	J
• 2 x PS 405, 10 A for 24 V DC, redundancy possible	K
Additive PROFIBUS DP interface modules¹⁾	
• Without CP 443-5 Extended	0
• 1 x CP 443-5 Extended	1
• 2 x CP 443-5 Extended	2
• 3 x CP 443-5 Extended ¹⁾	3
• 4 x CP 443-5 Extended ¹⁾	4

¹⁾ With the UR2 rack in combination with a redundant power supply, the number of additive CP 443-5 Extended is limited to 2

Selection and Ordering Data	Order No.
AS 416-2 with SIMATIC PCS 7 AS Runtime license for 100 POs CPU with 2 interfaces (MPI/DP and DP) 5.6 MB RAM (2.8 MB each for program and data)	6ES7 654-
Type of delivery	
• Preassembled and tested	8
Memory card	
• Memory card 4 MB RAM (up to approx. 300 POs)	C
• Memory card 8 MB RAM (up to approx. 800 POs)	D
CPU type	
• CPU 416-2 (up to approx. 800 POs)	G
Additive IF 964-DP interface module	
• Without additive IF 964-DP	0
Interface module to Industrial Ethernet plant bus	
• 1 x CP 443-1	1
Rack	
• UR2 (9 slots), aluminum	3
• UR2 (9 slots), steel	4
• UR1 (18 slots), aluminum	5
• UR1 (18 slots), steel	6
Power supply (without backup batteries)	
• 1 x PS 407, 10 A for 120/230 V AC/DC	B
• 1 x PS 407, 10 A for 120/230 V AC/DC, redundancy possible	C
• 1 x PS 407, 20 A for 120/230 V AC/DC	D
• 2 x PS 407, 10 A for 120/230 V AC/DC, redundancy possible	E
• 1 x PS 405, 10 A for 24 V DC	G
• 1 x PS 405, 10 A for 24 V DC, redundancy possible	H
• 1 x PS 405, 20 A for 24 V DC	J
• 2 x PS 405, 10 A for 24 V DC, redundancy possible	K
Additive PROFIBUS DP interface modules¹⁾	
• Without CP 443-5 Extended	0
• 1 x CP 443-5 Extended	1
• 2 x CP 443-5 Extended	2
• 3 x CP 443-5 Extended	3
• 4 x CP 443-5 Extended ¹⁾	4

¹⁾ With the UR2 rack in combination with a redundant power supply, the number of additive CP 443-5 Extended is limited to 3

10

Standard automation systems

Selection and Ordering Data	Order No.
AS 416-3 with SIMATIC PCS 7 AS Runtime license for 100 POs CPU with 3 interfaces (MPI/DP, DP and slot for IF module) 11.2 MB RAM (5.6 MB each for program and data)	6ES7 654-
Type of delivery	8
• Preassembled and tested	
Memory card	C
• Memory card 4 MB RAM (up to approx. 300 POs)	
• Memory card 8 MB RAM (up to approx. 800 POs)	D
• Memory card 16 MB RAM (up to approx. 3,000 POs)	E
CPU type	H
• CPU 416-3 (up to approx. 900 POs)	
Additive IF 964-DP interface module	0
• Without additive IF 964-DP	
• 1 x IF 964-DP	1
Interface module to Industrial Ethernet plant bus	1
• 1 x CP 443-1	
Rack	3
• UR2 (9 slots), aluminum	
• UR2 (9 slots), steel	4
• UR1 (18 slots), aluminum	5
• UR1 (18 slots), steel	6
Power supply (without backup batteries)	B
• 1 x PS 407, 10 A for 120/230 V AC/DC	
• 1 x PS 407, 10 A for 120/230 V AC/DC, redundancy possible	C
• 1 x PS 407, 20 A for 120/230 V AC/DC	D
• 2 x PS 407, 10 A for 120/230 V AC/DC, redundancy possible	E
• 1 x PS 405, 10 A for 24 V DC	G
• 1 x PS 405, 10 A for 24 V DC, redundancy possible	H
• 1 x PS 405, 20 A for 24 V DC	J
• 2 x PS 405, 10 A for 24 V DC, redundancy possible	K
Additive PROFIBUS DP interface modules¹⁾	0
• Without CP 443-5 Extended	
• 1 x CP 443-5 Extended	1
• 2 x CP 443-5 Extended	2
• 3 x CP 443-5 Extended ¹⁾	3
• 4 x CP 443-5 Extended ¹⁾	4

¹⁾ With the UR2 rack in combination with a redundant power supply, the number of additive CP 443-5 Extended is limited to 2

Selection and Ordering Data	Order No.
AS 417-4 with SIMATIC PCS 7 AS Runtime license for 100 POs CPU with 4 interfaces (MPI/DP, DP and 2 slots for IF modules) 30 MB RAM (15 MB each for program and data)	6ES7 654-
Type of delivery	8
• Preassembled and tested	
Memory card	C
• Memory card 4 MB RAM (up to approx. 300 POs)	
• Memory card 8 MB RAM (up to approx. 800 POs)	D
• Memory card 16 MB RAM (up to approx. 3,000 POs)	E
CPU type	K
• CPU 417-4 (up to approx. 3,000 POs)	
Additive IF 964-DP interface module	0
• Without additive IF 964-DP	
• 1 x IF 964-DP	1
• 2 x IF 964-DP	2
Interface module to Industrial Ethernet plant bus	1
• 1 x CP 443-1	
Rack	3
• UR2 (9 slots), aluminum	
• UR2 (9 slots), steel	4
• UR1 (18 slots), aluminum	5
• UR1 (18 slots), steel	6
Power supply (without backup batteries)	B
• 1 x PS 407, 10 A for 120/230 V AC/DC	
• 1 x PS 407, 10 A for 120/230 V AC/DC, redundancy possible	C
• 1 x PS 407, 20 A for 120/230 V AC/DC	D
• 2 x PS 407, 10 A for 120/230 V AC/DC, redundancy possible	E
• 1 x PS 405, 10 A for 24 V DC	G
• 1 x PS 405, 10 A for 24 V DC, redundancy possible	H
• 1 x PS 405, 20 A for 24 V DC	J
• 2 x PS 405, 10 A for 24 V DC, redundancy possible	K
Additive PROFIBUS DP interface modules¹⁾	0
• Without CP 443-5 Extended	
• 1 x CP 443-5 Extended	1
• 2 x CP 443-5 Extended	2
• 3 x CP 443-5 Extended ¹⁾	3
• 4 x CP 443-5 Extended ¹⁾	4

¹⁾ With the UR2 rack in combination with a redundant power supply, the number of additive CP 443-5 Extended is limited to 2

Automation systems

Standard automation systems

Selection and Ordering Data	Order No.
AS 414-3IE with SIMATIC PCS 7 AS Runtime license for 100 POs CPU with 2 DP interfaces (MPI/DP and slot for IF module) 2.8 MB RAM (1.4 MB each for program and data)	6ES7 654-
Type of delivery	
• Preassembled and tested	8
Memory card	
• Memory card 2 MB RAM (up to approx. 180 POs)	B
• Memory card 4 MB RAM (up to approx. 300 POs)	C
CPU type	
• CPU 414-3 PN/DP (up to approx. 250 POs)	D
Additive IF 964-DP interface module	
• Without additive IF 964-DP	0
• 1 x IF 964-DP	1
Interface module to Industrial Ethernet plant bus	
• Integrated, without CP 443-1	0
Rack	
• UR2 (9 slots), aluminum	3
• UR2 (9 slots), steel	4
• UR1 (18 slots), aluminum	5
• UR1 (18 slots), steel	6
Power supply (without backup batteries)	
• 1 x PS 407, 10 A for 120/230 V AC/DC	B
• 1 x PS 407, 10 A for 120/230 V AC/DC, redundancy possible	C
• 1 x PS 407, 20 A for 120/230 V AC/DC	D
• 2 x PS 407, 10 A for 120/230 V AC/DC, redundancy possible	E
• 1 x PS 405, 10 A for 24 V DC	G
• 1 x PS 405, 10 A for 24 V DC, redundancy possible	H
• 1 x PS 405, 20 A for 24 V DC	J
• 2 x PS 405, 10 A for 24 V DC, redundancy possible	K
Additive PROFIBUS DP interface modules¹⁾	
• Without CP 443-5 Extended	0
• 1 x CP 443-5 Extended	1
• 2 x CP 443-5 Extended	2
• 3 x CP 443-5 Extended	3
• 4 x CP 443-5 Extended ¹⁾	4

¹⁾ With the UR2 rack in combination with a redundant power supply, the number of additive CP 443-5 Extended is limited to 3

Selection and Ordering Data	Order No.
AS 416-3IE with SIMATIC PCS 7 AS Runtime license for 100 POs CPU with 2 DP interfaces (MPI/DP and slot for IF module) 11.2 MB RAM (5.6 MB each for program and data)	6ES7 654-
Type of delivery	
• Preassembled and tested	8
Memory card	
• Memory card 4 MB RAM (up to approx. 300 POs)	C
• Memory card 8 MB RAM (up to approx. 800 POs)	D
• Memory card 16 MB RAM (up to approx. 3,000 POs)	E
CPU type	
• CPU 416-3 PN/DP (up to approx. 900 POs)	J
Additive IF 964-DP interface module	
• Without additive IF 964-DP	0
• 1 x IF 964-DP	1
Interface module to Industrial Ethernet plant bus	
• Integrated, without CP 443-1	0
Rack	
• UR2 (9 slots), aluminum	3
• UR2 (9 slots), steel	4
• UR1 (18 slots), aluminum	5
• UR1 (18 slots), steel	6
Power supply (without backup batteries)	
• 1 x PS 407, 10 A for 120/230 V AC/DC	B
• 1 x PS 407, 10 A for 120/230 V AC/DC, redundancy possible	C
• 1 x PS 407, 20 A for 120/230 V AC/DC	D
• 2 x PS 407, 10 A for 120/230 V AC/DC, redundancy possible	E
• 1 x PS 405, 10 A for 24 V DC	G
• 1 x PS 405, 10 A for 24 V DC, redundancy possible	H
• 1 x PS 405, 20 A for 24 V DC	J
• 2 x PS 405, 10 A for 24 V DC, redundancy possible	K
Additive PROFIBUS DP interface modules¹⁾	
• Without CP 443-5 Extended	0
• 1 x CP 443-5 Extended	1
• 2 x CP 443-5 Extended	2
• 3 x CP 443-5 Extended	3
• 4 x CP 443-5 Extended ¹⁾	4

¹⁾ With the UR2 rack in combination with a redundant power supply, the number of additive CP 443-5 Extended is limited to 3

Recommended preferred types

Selection and Ordering Data

Order No.

SIMATIC PCS 7 standard automation systems with Industrial Ethernet interfacing via CP, recommended preferred types**AS 414-3 automation system with SIMATIC PCS 7**

AS Runtime license for 100 POs
Preassembled and tested, without additive IF 964-DP and without CP 443-5 Extended, comprising:

CPU 414-3 with 3 interfaces (MPI/DP, DP and slot for IF module), 2.8 MB RAM (1.4 MB each for program and data), CP 443-1 communications processor for connection to Industrial Ethernet plant bus as well as

- Aluminum UR1 rack (18 slots):

- PS 407 power supply; 20 A for 120/230 V AC/DC, without backup batteries, memory card 2 MB RAM

6ES7 654-8BC01-5DB0 B)

- PS 407 power supply; 20 A for 120/230 V AC/DC, without backup batteries, memory card 4 MB RAM

6ES7 654-8CC01-5DB0 B)

- PS 405 power supply; 20 A for 24 V DC, without backup batteries, memory card 2 MB RAM

6ES7 654-8BC01-5JB0 B)

- PS 405 power supply; 20 A for 24 V DC, without backup batteries, memory card 4 MB RAM

6ES7 654-8CC01-5JB0 B)

- Aluminum UR2 rack (9 slots):

- PS 407 power supply; 10 A for 120/230 V AC/DC, without backup batteries, memory card 2 MB RAM

6ES7 654-8BC01-3BB0 B)

- PS 407 power supply; 10 A for 120/230 V AC/DC, without backup batteries, memory card 4 MB RAM

6ES7 654-8CC01-3BB0 B)

- PS 405 power supply; 10 A for 24 V DC, without backup batteries, memory card 2 MB RAM

6ES7 654-8BC01-3GB0 B)

- PS 405 power supply; 10 A for 24 V DC, without backup batteries, memory card 4 MB RAM

6ES7 654-8CC01-3GB0 B)

Selection and Ordering Data

Order No.

AS 416-2 automation system with SIMATIC PCS 7

AS Runtime license for 100 POs
Preassembled and tested, without additive IF 964-DP and without CP 443-5 Extended, comprising:

CPU 416-2 with 2 interfaces (MPI/DP and DP), 5.6 MB RAM (2.8 MB each for program and data), CP 443-1 communications processor for connection to Industrial Ethernet plant bus as well as

- Aluminum UR1 rack (18 slots):

- PS 407 power supply; 20 A for 120/230 V AC/DC, without backup batteries, memory card 4 MB RAM

6ES7 654-8CG01-5DB0 B)

- PS 407 power supply; 20 A for 120/230 V AC/DC, without backup batteries, memory card 8 MB RAM

6ES7 654-8DG01-5DB0 B)

- PS 405 power supply; 20 A for 24 V DC, without backup batteries, memory card 4 MB RAM

6ES7 654-8CG01-5JB0 B)

- PS 405 power supply; 20 A for 24 V DC, without backup batteries, memory card 8 MB RAM

6ES7 654-8DG01-5JB0 B)

- Aluminum UR2 rack (9 slots):

- PS 407 power supply; 10 A for 120/230 V AC/DC, without backup batteries, memory card 4 MB RAM

6ES7 654-8CG01-3BB0 B)

- PS 407 power supply; 10 A for 120/230 V AC/DC, without backup batteries, memory card 8 MB RAM

6ES7 654-8DG01-3BB0 B)

- PS 405 power supply; 10 A for 24 V DC, without backup batteries, memory card 4 MB RAM

6ES7 654-8CG01-3GB0 B)

- PS 405 power supply; 10 A for 24 V DC, without backup batteries, memory card 8 MB RAM

6ES7 654-8DG01-3GB0 B)

B) Subject to export regulations: AL: N, ECCN: EAR99H

Automation systems

Standard automation systems

Selection and Ordering Data

Order No.

AS 416-3 automation system with SIMATIC PCS 7

AS Runtime license for 100 POs

Preassembled and tested, without additive IF 964-DP and without CP 443-5 Extended, comprising:

CPU 416-3 with 3 interfaces (MPI/DP, DP and slot for IF module), 11.2 MB RAM (5.6 MB each for program and data), CP 443-1 communications processor for connection to Industrial Ethernet plant bus as well as

- Aluminum UR1 rack (18 slots):

- PS 407 power supply; 20 A for 120/230 V AC/DC, without backup batteries, memory card 8 MB RAM

6ES7 654-8DH01-5DB0 B)

- PS 407 power supply; 20 A for 120/230 V AC/DC, without backup batteries, memory card 16 MB RAM

6ES7 654-8EH01-5DB0 B)

- PS 405 power supply; 20 A for 24 V DC, without backup batteries, memory card 8 MB RAM

6ES7 654-8DH01-5JB0 B)

- PS 405 power supply; 20 A for 24 V DC, without backup batteries, memory card 16 MB RAM

6ES7 654-8EH01-5JB0 B)

- Aluminum UR2 rack (9 slots):

- PS 407 power supply; 10 A for 120/230 V AC/DC, without backup batteries, memory card 8 MB RAM

6ES7 654-8DH01-3BB0 B)

- PS 407 power supply; 10 A for 120/230 V AC/DC, without backup batteries, memory card 16 MB RAM

6ES7 654-8EH01-3BB0 B)

- PS 405 power supply; 10 A for 24 V DC, without backup batteries, memory card 8 MB RAM

6ES7 654-8DH01-3GB0 B)

- PS 405 power supply; 10 A for 24 V DC, without backup batteries, memory card 16 MB RAM

6ES7 654-8EH01-3GB0 B)

Selection and Ordering Data

Order No.

AS 417-4 automation system with SIMATIC PCS 7

AS Runtime license for 100 POs

Preassembled and tested, without additive IF 964-DP and without CP 443-5 Extended, comprising:

CPU 417-4 with 4 interfaces (MPI/DP, DP and 2 slots for IF modules), 30 MB RAM (15 MB each for program and data), CP 443-1 communications processor for connection to Industrial Ethernet plant bus as well as

- Aluminum UR1 rack (18 slots):

- PS 407 power supply; 20 A for 120/230 V AC/DC, without backup batteries, memory card 4 MB RAM

6ES7 654-8CK01-5DB0 B)

- PS 407 power supply; 20 A for 120/230 V AC/DC, without backup batteries, memory card 16 MB RAM

6ES7 654-8EK01-5DB0 B)

- PS 405 power supply; 20 A for 24 V DC, without backup batteries, memory card 4 MB RAM

6ES7 654-8CK01-5JB0 B)

- PS 405 power supply; 20 A for 24 V DC, without backup batteries, memory card 16 MB RAM

6ES7 654-8EK01-5JB0 B)

- Aluminum UR2 rack (9 slots):

- PS 407 power supply; 10 A for 120/230 V AC/DC, without backup batteries, memory card 4 MB RAM

6ES7 654-8CK01-3BB0 B)

- PS 407 power supply; 10 A for 120/230 V AC/DC, without backup batteries, memory card 16 MB RAM

6ES7 654-8EK01-3BB0 B)

- PS 405 power supply; 10 A for 24 V DC, without backup batteries, memory card 4 MB RAM

6ES7 654-8CK01-3GB0 B)

- PS 405 power supply; 10 A for 24 V DC, without backup batteries, memory card 16 MB RAM

6ES7 654-8EK01-3GB0 B)

B) Subject to export regulations: AL: N, ECCN: EAR99H

Standard automation systems

Selection and Ordering Data Order No.

SIMATIC PCS 7 standard automation systems with integral Industrial Ethernet interface module, recommended preferred types**AS 414-3IE automation system with SIMATIC PCS 7****AS Runtime license for 100 POs**

Preassembled and tested, without CP 4435 Extended, comprising:

CPU 414-3 PN/DP with 2 DP interfaces (MPI/DP and preassembled IF 964-DP module), 2.8 MB RAM (1.4 MB each for program and data), as well as

- Aluminum UR2 rack (9 slots):
 - PS 407 power supply; 10 A for 120/230 V AC/DC, without backup batteries, memory card 2 MB RAM
 - PS 407 power supply; 10 A for 120/230 V AC/DC, without backup batteries, memory card 4 MB RAM
 - PS 405 power supply; 10 A for 24 V DC, without backup batteries, memory card 2 MB RAM
 - PS 405 power supply; 10 A for 24 V DC, without backup batteries, memory card 4 MB RAM

6ES7 654-8BD10-3BB0 B)**6ES7 654-8CD10-3BB0** B)**6ES7 654-8BD10-3GB0** B)**6ES7 654-8CD10-3GB0** B)**AS 416-3IE automation system with Runtime license for 100 POs**

Preassembled and tested, without CP 443-5 Extended, comprising:

CPU 416-3 PN/DP with 2 DP interfaces (MPI/DP and preassembled IF 964-DP module), 11.2 MB RAM (5.6 MB each for program and data), as well as

- Aluminum UR2 rack (9 slots):
 - PS 407 power supply; 10 A for 120/230 V AC/DC, without backup batteries, memory card 4 MB RAM
 - PS 407 power supply; 10 A for 120/230 V AC/DC, without backup batteries, memory card 16 MB RAM
 - PS 405 power supply; 10 A for 24 V DC, without backup batteries, memory card 4 MB RAM
 - PS 405 power supply; 10 A for 24 V DC, without backup batteries, memory card 16 MB RAM

6ES7 654-8CJ10-3BB0 B)**6ES7 654-8EJ10-3BB0** B)**6ES7 654-8CJ10-3GB0** B)**6ES7 654-8EJ10-3GB0** B)

Selection and Ordering Data Order No.

Runtime licenses for SIMATIC PCS 7 automation systems (can be added to existing licenses)**SIMATIC PCS 7 AS Runtime license**

6 languages (German, English, French, Italian, Spanish, Chinese), executes in the engineering system with Windows XP Professional, floating license for 1 installation

Type of delivery:
License key disk, certificate of license, terms and conditions

- 100 POs
- 1,000 POs
- 10,000 POs

6ES7 653-2BA00-0XB5**6ES7 653-2BB00-0XB5****6ES7 653-2BC00-0XB5****Individual components**

Selection and Ordering Data Order No.

Individual components for standard SIMATIC PCS 7 automation systems**CPU 414-3**

RAM 2.8 MB (1.4 MB each for program and data); module occupies 2 slots

6ES7 414-3XM05-0AB0 B)**CPU 416-2**

RAM 5.6 MB (2.8 MB each for program and data); module occupies 1 slot

6ES7 416-2XN05-0AB0 B)**CPU 416-3**

RAM 11.2 MB (5.6 MB each for program and data); module occupies 2 slots

6ES7 416-3XR05-0AB0 B)**CPU 417-4**

RAM 30 MB (15 MB each for program and data); module occupies 2 slots

6ES7 417-4XT05-0AB0**CPU 414-3 PN/DP**

RAM 2.8 MB (1.4 MB each for program and data); module occupies 2 slots

6ES7 414-3EM05-0AB0 B)**CPU 416-3 PN/DP**

RAM 11.2 MB (5.6 MB each for program and data); module occupies 2 slots

6ES7 416-3ER05-0AB0 B)**Memory card RAM**

- 2 MB
- 4 MB
- 8 MB
- 16 MB
- 64 MB

6ES7 952-1AL00-0AA0**6ES7 952-1AM00-0AA0****6ES7 952-1AP00-0AA0****6ES7 952-1AS00-0AA0****6ES7 952-1AY00-0AA0****Memory Card Flash-EPROM**

Only required to update firmware

- 8 MB

6ES7 952-1KP00-0AA0

B) Subject to export regulations: AL: N, ECCN: EAR99H

Automation systems

Standard automation systems

Selection and Ordering Data	Order No.	Selection and Ordering Data	Order No.
CP 443-1 Communications processor for connection of SIMATIC S7-400 to Industrial Ethernet through TCP/IP, ISO and UDP; for S7 communication, S5-compatible communication (SEND/RECEIVE) with FETCH/WRITE with or without RFC 1006, diagnostics expansion, Multicast, commissioning through LAN 10/100 Mbit/s, with electronic manual on CD-ROM	6GK7 443-1EX11-0XE0	PS 405 power supply module; 10 A, redundant design possible 24 V DC; 5 V DC/10 A, 24 V DC/1 A; with battery compartment for 2 backup batteries, module occupies 2 slots	6ES7 405-0KR02-0AA0 B)
CP 443-5 Extended Communications processor for connection of SIMATIC S7-400 to PROFIBUS as DP master or for S7 communication, for increasing the number of DP lines, for data set routing with SIMATIC PDM and for 10-ms time stamp, electronic manual on CD; module occupies 1 slot	6GK7 443-5DX04-0XE0	PS 405 power supply module; 20 A 24 V DC; 5 V DC/20 A, 24 V DC/1 A; with battery compartment for 2 backup batteries, module occupies 2 slots	6ES7 405-0RA02-0AA0
IF 964-DP Interface module for connection of another PROFIBUS DP line, for plugging into a free DP module slot of the CPU	6ES7 964-2AA04-0AB0	Backup battery Type AA, 2.3 Ah	6ES7 971-0BA00
PS 407 power supply module; 4 A 120/230 V AC/DC; 5 V DC/4 A, 24 V DC/0.5 A; with battery compartment for 1 backup battery, module occupies 1 slot	6ES7 407-0DA02-0AA0	Aluminum UR1 rack 18 slots	6ES7 400-1TA11-0AA0 B)
PS 407 power supply module; 10 A 120/230 V AC/DC; 5 V DC/10 A, 24 V DC/1 A; with battery compartment for 2 backup batteries, module occupies 2 slots	6ES7 407-0KA02-0AA0	Aluminum UR2 rack 9 slots	6ES7 400-1JA11-0AA0
PS 407 power supply module; 10 A, redundant design possible 120/230 V AC/DC; 5 V DC/10 A, 24 V DC/1 A; with battery compartment for 2 backup batteries, module occupies 2 slots	6ES7 407-0KR02-0AA0	Aluminum CR3 rack 4 slots	6ES7 401-1DA01-0AA0
PS 407 power supply module; 20 A 120/230 V AC/DC; 5 V DC/20 A, 24 V DC/1 A; with battery compartment for 2 backup batteries, module occupies 2 slots	6ES7 407-0RA02-0AA0	Steel UR1 rack 18 slots	6ES7 400-1TA01-0AA0
PS 405 power supply module; 4 A 24 V DC; 5 V DC/4 A, 24 V DC/0.5 A; with battery compartment for 1 backup battery, module occupies 1 slot	6ES7 405-0DA02-0AA0	Steel UR2 rack 9 slots	6ES7 400-1JA01-0AA0
PS 405 power supply module; 10 A 24 V DC; 5 V DC/10 A, 24 V DC/1 A; with battery compartment for 2 backup batteries, module occupies 2 slots	6ES7 405-0KA02-0AA0		

B) Subject to export regulations: AL: N, ECCN: EAR99H

Overview



Fault-tolerant automation systems are used to reduce the risk of production failures. The higher investment costs for fault-tolerant automation systems are frequently negligible compared to the costs resulting from production failures. The higher the costs of a production failure, the more worthwhile it is to use a fault-tolerant system.

Fault-tolerant automation systems can be mounted in a UR2-H compact rack with divided backplane bus or in two separate racks (UR1 or UR2). The design in two racks allows physical separation of the redundant subsystems, e.g. by a fireproof partition.

Fault-tolerant automation systems can be used on their own in a plant configuration, or together with standard and safety-related automation systems.

Design

Fault-tolerant automation systems for SIMATIC PCS 7 are available as preassembled and tested all-in-one systems (AS bundles) at no extra charge.

Depending on the type of automation system, the RAM of these AS bundles varies as follows:

AS type	Main memory
AS 412H	768 KB (512 KB for program and 256 KB for data)
AS 414H	2.8 MB (1.4 MB each for program and data)
AS 417H	30 MB (15 MB each for program and data)

Runtime licenses

Each AS bundle is already provided as standard with the SIMATIC PCS 7 AS Runtime license for 100 process objects (PO). The number of process objects can be extended by additional Runtime licenses for 100, 1000 or 10000 POs. The process objects of additional Runtime licenses can be added to process objects which already exist. The number and type (e.g. 100 or 1000) of additional Runtime licenses are irrelevant. The AS Runtime licenses are administered on a SIMATIC PCS 7 engineering system or in the SIMATIC PCS 7 BOX.

Connection of process I/Os

Several PROFIBUS DP lines with distributed process I/Os can be operated on each sub-AS through the internal PROFIBUS DP interface or by using additional communications processors.

- The ET 200M remote I/O stations are connected via two IM 153-2 High Feature interface modules on a special bus module to two redundant PROFIBUS DP segments.
- The intelligent field devices on the PROFIBUS PA are connected over a DP/PA link to two redundant IM 153-2 High Feature interface modules.
- Non-redundant PROFIBUS DP devices, e.g. ET 200S distributed I/O devices, can be connected to the redundant PROFIBUS DP over the Y-link.

These configurations can also be mixed together.

Communication over the plant bus

The AS 412H, AS 414H and AS 417H automation systems are connected as standard by one communications processor per sub-AS to the plant bus.

The plant bus can be implemented in the form of a ring structure, which can also be configured with redundant architecture if the availability requirements are high. When there are two redundant rings it makes sense to use two communications processors per sub-AS and to distribute their connections between the two rings (4-way connection). Double faults such as failure of the OSM/SCALANCE switch on ring 1 with simultaneous interruption in the bus cable on ring 2 can thus be tolerated.

Automation systems

Fault-tolerant automation systems

Individual configuration of AS bundles

The equipment of the fault-tolerant automation systems as well as their Order Nos. can be individually compiled by selecting preconfigured ordering units. System-specific ordering configurations are available for this purpose in the following Section "Selection and ordering data".

These are divided into:

- Single stations: AS 412-3-1H, AS 414-4-1H and AS 417-4-1H with only one CPU, e.g. for the following cases:
 - Subsequent expansion to a redundant system
 - Redundant configuration on UR1 racks, comprising 2 Single Stations, 4 sync modules and 2 sync fiber-optic cables
- Redundant stations: AS 412-3-2H, AS 414-4-2H and AS 417-4-2H with two redundant CPUs, mounted on one common rack (UR2-H) or two separate racks (UR2)

In order to rapidly access the recommended preferred configurations, these are additionally listed with their complete Order Numbers.

As an alternative to the ordering data in this catalog, the configurator offered in the catalog & online ordering system "A&D Mall" (www.siemens.com/automation/mall) can also be used to select and order fault-tolerant automation systems for SIMATIC PCS 7.

Ordering information:

For a redundant configuration based on 2 Single Stations, you additionally require 4 sync modules (up to 10 m or 10 km) and 2 fiber-optic sync cables. Their selection depends on the distance between the two Single Stations.

The AS 412H (AS 412-3-1H/AS 412-3-2H) automation systems currently only support sync modules with a range up to 10 m. Fiber-optic sync cables longer than 1 m must always be ordered separately (2 of each required).

Function

The fault-tolerant automation systems of SIMATIC PCS 7 are based on the 1-out-of-2 principle. In the event of a fault, they switch over to the standby system. These systems use a completely redundant design to maximize availability. Therefore all important system components are present twice, such as:

- Central processing unit
- Power supply
- Hardware for linking the two CPUs

Which other components are also made available in pairs in the interest of availability depends on the application-specific system architecture.

The two subsystems of a redundant automation system are electrically isolated from one another. This increases the system stability with respect to electromagnetic interference.

The firmware of the fault-tolerant automation systems can be updated in two ways:

- Per Flash-EPROM memory card (8 MB)
- From the central engineering system via the Industrial Ethernet plant bus

Fault-tolerant automation systems

Selection and ordering data	Order No.
AS 412-3-1H (Single Station) with SIMATIC PCS 7 AS Runtime license for 100 POs CPU with 1 interface (MPI/DP master) 768 KB RAM (512 KB for program and 256 KB for data)	6ES7 654-
Type of delivery	
• Preassembled and tested	8
Memory card	
• Memory card 1 MB RAM (up to approx. 50 POs)	A
• Memory card 2 MB RAM (up to approx. 180 POs)	B
CPU type	
• CPU 412-3H (up to approx. 50 POs)	A
Additive IF 964-DP interface module	
• Without additive IF 964-DP	0
Interface module to Industrial Ethernet plant bus¹⁾	
• 1 x CP 443-1 ¹⁾	1
• 2 x CP 443-1 for redundant interface module ¹⁾	2
Rack	
• UR2 (9 slots), aluminum	3
• UR2 (9 slots), steel	4
• UR1 (18 slots), aluminum	5
• UR1 (18 slots), steel	6
Power supply (without backup batteries)	
• 1 x PS 407, 10 A for 120/230 V AC/DC	B
• 1 x PS 407, 10 A for 120/230 V AC/DC, redundant design possible	C
• 1 x PS 407, 20 A for 120/230 V AC/DC	D
• 2 x PS 407, 10 A for 120/230 V AC/DC, redundant design possible	E
• 1 x PS 405, 10 A for 24 V DC	G
• 1 x PS 405, 10 A for 24 V DC, redundant design possible	H
• 1 x PS 405, 20 A for 24 V DC	J
• 2 x PS 405, 10 A for 24 V DC, redundant design	K
Additive PROFIBUS DP interface modules¹⁾	
• Without CP 443-5 Extended	0
• 1 x CP 443-5 Extended	1
• 2 x CP 443-5 Extended ¹⁾	2
• 3 x CP 443-5 Extended ¹⁾	3
• 4 x CP 443-5 Extended ¹⁾	4

¹⁾ Up to 5 CPs can be plugged into the UR2 rack with a single power supply, or up to 3 with a redundant power supply.

Selection and ordering data	Order No.
AS 414-4-1H (Single Station) with SIMATIC PCS 7 AS Runtime license for 100 POs CPU with 2 interfaces (MPI/DP master and DP master) 2.8 MB RAM (1.4 MB each for program and data)	6ES7 654-
Type of delivery	
• Preassembled and tested	8
Memory card	
• Memory card 2 MB RAM (up to approx. 180 POs)	B
• Memory card 4 MB RAM (up to approx. 300 POs)	C
CPU type	
• CPU 414-4H (up to approx. 250 POs)	E
Additive IF 964-DP interface module	
• Without additive IF 964-DP	0
Interface module to Industrial Ethernet plant bus¹⁾	
• 1 x CP 443-1 ¹⁾	1
• 2 x CP 443-1 for redundant interface module ¹⁾	2
Rack	
• UR2 (9 slots), aluminum	3
• UR2 (9 slots), steel	4
• UR1 (18 slots), aluminum	5
• UR1 (18 slots), steel	6
Power supply (without backup batteries)	
• 1 x PS 407, 10 A for 120/230 V AC/DC	B
• 1 x PS 407, 10 A for 120/230 V AC/DC, redundant design	C
• 1 x PS 407, 20 A for 120/230 V AC/DC	D
• 2 x PS 407, 10 A for 120/230 V AC/DC, redundant design	E
• 1 x PS 405, 10 A for 24 V DC	G
• 1 x PS 405, 10 A for 24 V DC, redundant design	H
• 1 x PS 405, 20 A for 24 V DC	J
• 2 x PS 405, 10 A for 24 V DC, redundant design	K
Additive PROFIBUS DP interface modules¹⁾	
• Without CP 443-5 Extended	0
• 1 x CP 443-5 Extended	1
• 2 x CP 443-5 Extended ¹⁾	2
• 3 x CP 443-5 Extended ¹⁾	3
• 4 x CP 443-5 Extended ¹⁾	4

¹⁾ Up to 5 CPs can be plugged into the UR2 rack with a single power supply, or up to 3 with a redundant power supply.

Automation systems

Fault-tolerant automation systems

Selection and ordering data	Order No.
AS 417-4-1H (Single Station) with SIMATIC PCS 7 AS Runtime license for 100 POs CPU with 2 interfaces (MPI/DP master and DP master) 30 MB RAM (15 MB each for program and data)	6ES7 654-
Type of delivery	
• Preassembled and tested	8
Memory card	
• Memory card 4 MB RAM (up to approx. 300 POs)	C
• Memory card 8 MB RAM (up to approx. 800 POs)	D
• Memory card 16 MB RAM (up to approx. 3,000 POs)	E
CPU type	
• CPU 417-4H (up to approx. 2,500 POs)	M
Additive IF 964-DP interface module	
• Without additive IF 964-DP	0
• 1 x IF 964-DP	1
Interface module to Industrial Ethernet plant bus¹⁾	
• 1 x CP 443-1 ¹⁾	1
• 2 x CP 443-1 for redundant interface module ¹⁾	2
Rack	
• UR2 (9 slots), aluminum	3
• UR2 (9 slots), steel	4
• UR1 (18 slots), aluminum	5
• UR1 (18 slots), steel	6
Power supply (without backup batteries)	
• 1 x PS 407, 10 A for 120/230 V AC/DC	B
• 1 x PS 407, 10 A for 120/230 V AC/DC, redundant design	C
• 1 x PS 407, 20 A for 120/230 V AC/DC	D
• 2 x PS 407, 10 A for 120/230 V AC/DC, redundant design	E
• 1 x PS 405, 10 A for 24 V DC	G
• 1 x PS 405, 10 A for 24 V DC, redundant design	H
• 1 x PS 405, 20 A for 24 V DC	J
• 2 x PS 405, 10 A for 24 V DC, redundant design	K
Additive PROFIBUS DP interface modules¹⁾	
• Without CP 443-5 Extended	0
• 1 x CP 443-5 Extended	1
• 2 x CP 443-5 Extended ¹⁾	2
• 3 x CP 443-5 Extended ¹⁾	3
• 4 x CP 443-5 Extended ¹⁾	4

¹⁾ Up to 5 CPs can be plugged into the UR2 rack with a single power supply, or up to 3 with a redundant power supply.

Selection and ordering data	Order No.
AS 412-3-2H (Redundant Station) with SIMATIC PCS 7 AS Runtime license for 100 POs 2 x CPU with 1 interface each (MPI/DP master) 2 x 768 KB RAM (512 KB each for program and 256 KB each for data)	6ES7 656-
Type of delivery	
• Preassembled and tested	8
Memory card	
• 2 x memory card 1 MB RAM (up to approx. 50 POs)	A
• 2 x memory card 2 MB RAM (up to approx. 180 POs)	B
CPU type	
• 2 x CPU 412-3H (up to approx. 50 POs)	A
Sync modules and cables	
• 2 x 2 sync modules for distances up to 10 m and 2 x FO sync cable, 1 m	3
Interface module to Industrial Ethernet plant bus¹⁾	
• 2 x CP 443-1 for redundant interface module ¹⁾	1
• 2 x 2 CP 443-1 for 4-way connection ¹⁾	2
Rack	
• 1 x UR2-H (2 x 9 slots), aluminum	1
• 1 x UR2-H (2 x 9 slots), steel	2
• 2 x UR2 (9 slots), aluminum	3
• 2 x UR2 (9 slots), steel	4
Power supply (without backup batteries)	
• 2 x PS 407, 10 A for 120/230 V AC/DC	B
• 2 x PS 407, 10 A for 120/230 V AC/DC, redundant design	C
• 2 x PS 407, 20 A for 120/230 V AC/DC	D
• 2 x 2 PS 407, 10 A for 120/230 V AC/DC, redundant design	E
• 2 x PS 405, 10 A for 24 V DC	G
• 2 x PS 405, 10 A for 24 V DC, redundant design	H
• 2 x PS 405, 20 A for 24 V DC	J
• 2 x PS 405, 10 A for 24 V DC, redundant design	K
Additive PROFIBUS DP interface modules¹⁾	
• Without CP 443-5 Extended	0
• 2 x CP 443-5 Extended	1
• 2 x 2 CP 443-5 Extended ¹⁾	2
• 2 x 3 CP 443-5 Extended ¹⁾	3
• 2 x 4 CP 443-5 Extended ¹⁾	4

¹⁾ Up to 5 CPs can be plugged in per subsystem with a single power supply, or up to 3 with a redundant power supply.

Fault-tolerant automation systems

Selection and ordering data	Order No.
AS 414-4-2H (Redundant Station) with SIMATIC PCS 7 AS Runtime license for 100 POs 2 x CPU with 2 interfaces (MPI/DP master and DP master) 2 x 2.8 MB RAM (1.4 MB each for program and data)	6ES7 656-
Type of delivery	
• Preassembled and tested	8
Memory card	
• 2 x memory card 2 MB RAM (up to approx. 180 POs)	B
• 2 x memory card 4 MB RAM (up to approx. 300 POs)	C
CPU type	
• 2 x CPU 414-4H (up to approx. 250 POs)	E
Sync modules and cables	
• 2 x 2 sync modules for distances up to 10 m and 2 x FO sync cable, 1 m	3
• 2 x 2 sync modules for up to 10 km and 2 x FO sync cable, 1 m, for testing	4
Interface module to Industrial Ethernet plant bus¹⁾	
• 2 x CP 443-1 for redundant interface module ¹⁾	1
• 2 x 2 CP 443-1 for 4-way connection ¹⁾	2
Rack	
• 1 x UR2-H (2 x 9 slots), aluminum	1
• 1 x UR2-H (2 x 9 slots), steel	2
• 2 x UR2 (9 slots), aluminum	3
• 2 x UR2 (9 slots), steel	4
Power supply (without backup batteries)	
• 2 x PS 407, 10 A for 120/230 V AC/DC	B
• 2 x PS 407, 10 A for 120/230 V AC/DC, redundant design	C
• 2 x PS 407, 20 A for 120/230 V AC/DC	D
• 2 x 2 PS 407, 10 A for 120/230 V AC/DC, redundant design	E
• 2 x PS 405, 10 A for 24 V DC	G
• 2 x PS 405, 10 A for 24 V DC, redundant design	H
• 2 x PS 405, 20 A for 24 V DC	J
• 2 x PS 405, 10 A for 24 V DC, redundant design	K
Additive PROFIBUS DP interface modules¹⁾	
• Without CP 443-5 Extended	0
• 2 x CP 443-5 Extended	1
• 2 x 2 CP 443-5 Extended ¹⁾	2
• 2 x 3 CP 443-5 Extended ¹⁾	3
• 2 x 4 CP 443-5 Extended ¹⁾	4

¹⁾ Up to 5 CPs can be plugged in per subsystem with a single power supply, or up to 3 with a redundant power supply.

Selection and ordering data	Order No.
AS 417-4-2H (Redundant Station) with SIMATIC PCS 7 AS Runtime license for 100 POs 2 x CPU with 2 interfaces (MPI/DP master and DP master) 2 x 30 MB RAM (15 MB each for program and data)	6ES7 656-
Type of delivery	
• Preassembled and tested	8
Memory card	
• 2 x memory card 4 MB RAM (up to approx. 300 POs)	C
• 2 x memory card 8 MB RAM (up to approx. 800 POs)	D
• 2 x memory card 16 MB RAM (up to approx. 3,000 POs)	E
CPU type	
• 2 x CPU 417-4H (up to approx. 2,500 POs)	M
Sync modules and cables	
• 2 x 2 sync modules for distances up to 10 m and 2 x FO sync cable, 1 m	3
• 2 x 2 sync modules for up to 10 km and 2 x FO sync cable, 1 m, for testing	4
Interface module to Industrial Ethernet plant bus¹⁾	
• 2 x CP 443-1 for redundant interface module ¹⁾	1
• 2 x 2 CP 443-1 for 4-way connection ¹⁾	2
Rack	
• 1 x UR2-H (2 x 9 slots), aluminum	1
• 1 x UR2-H (2 x 9 slots), steel	2
• 2 x UR2 (9 slots), aluminum	3
• 2 x UR2 (9 slots), steel	4
Power supply (without backup batteries)	
• 2 x PS 407, 10 A for 120/230 V AC/DC	B
• 2 x PS 407, 10 A for 120/230 V AC/DC, redundant design	C
• 2 x PS 407, 20 A for 120/230 V AC/DC	D
• 2 x 2 PS 407, 10 A for 120/230 V AC/DC, redundant design	E
• 2 x PS 405, 10 A for 24 V DC	G
• 2 x PS 405, 10 A for 24 V DC, redundant design	H
• 2 x PS 405, 20 A for 24 V DC	J
• 2 x PS 405, 10 A for 24 V DC, redundant design	K
Additive PROFIBUS DP interface modules¹⁾	
• Without CP 443-5 Extended	0
• 2 x CP 443-5 Extended	1
• 2 x 2 CP 443-5 Extended ¹⁾	2
• 2 x 3 CP 443-5 Extended ¹⁾	3
• 2 x 4 CP 443-5 Extended ¹⁾	4

¹⁾ Up to 5 CPs can be plugged in per subsystem with a single power supply, or up to 3 with a redundant power supply.

Automation systems

Fault-tolerant automation systems

Recommended preferred types

Selection and Ordering Data

Order No.

Fault-tolerant SIMATIC PCS 7 automation systems - Single Stations, recommended preferred types

AS 412-3-1H automation system with SIMATIC PCS 7

AS Runtime license for 100 POs

Preassembled and tested, without CP 443-5 Extended, without sync modules and cables, comprising:

1 x CPU 412-3H with one integrated interface (MPI/DP master), 768 KB main memory (512 KB for program and 256 KB for data), CP 443-1 communications processor for connection to Industrial Ethernet plant bus as well as

- UR2 aluminum rack (9 slots)
 - PS 407 power supply; 10 A for 120/230 V AC/DC, redundant design, without backup batteries, memory card 2 MB RAM
 - PS 405 power supply; 10 A for 24 V DC, without backup batteries, memory card 2 MB RAM

6ES7 654-8BA01-3CB0 B)

6ES7 654-8BA01-3GB0 B)

AS 414-4-1H automation system with SIMATIC PCS 7

AS Runtime license for 100 POs

Preassembled and tested, without CP 443-5 Extended, without sync modules and cables, comprising:

1 x CPU 414-4H with 2 integrated interfaces (MPI/DP master and DP master), 2.8 MB main memory (1.4 MB each for program and data), CP 443-1 communications processor for connection to Industrial Ethernet plant bus as well as

- UR2 aluminum rack (9 slots)
 - PS 407 power supply; 10 A for 120/230 V AC/DC, redundant design, without backup batteries, memory card 2 MB RAM
 - PS 407 power supply; 10 A for 120/230 V AC/DC, redundant design, without backup batteries, memory card 4 MB RAM
 - PS 405 power supply; 10 A for 24 V DC, without backup batteries, memory card 2 MB RAM
 - PS 405 power supply; 10 A for 24 V DC, without backup batteries, memory card 4 MB RAM

6ES7 654-8BE01-3CB0 B)

6ES7 654-8CE01-3CB0 B)

6ES7 654-8BE01-3GB0 B)

6ES7 654-8CE01-3GB0 B)

Selection and Ordering Data

Order No.

AS 417-4-1H automation system with SIMATIC PCS 7

AS Runtime license for 100 POs

Preassembled and tested, without CP 443-5 Extended, without sync modules and cables, comprising:

1 x CPU 417-4H with 2 integrated interfaces (MPI/DP master and DP master), 30 MB main memory (15 MB each for program and data), CP 443-1 communications processor for connection to Industrial Ethernet plant bus as well as

- UR2 aluminum rack (9 slots)
 - PS 407 power supply; 10 A for 120/230 V AC/DC, redundant design, without backup batteries, memory card 4 MB RAM
 - PS 407 power supply; 10 A for 120/230 V AC/DC, redundant design, without backup batteries, memory card 16 MB RAM
 - PS 405 power supply; 10 A for 24 V DC, without backup batteries, memory card 4 MB RAM
 - PS 405 power supply; 10 A for 24 V DC, without backup batteries, memory card 16 MB RAM

6ES7 654-8CM01-3CB0 B)

6ES7 654-8EM01-3CB0 B)

6ES7 654-8CM01-3GB0 B)

6ES7 654-8EM01-3GB0 B)

Fault-tolerant SIMATIC PCS 7 automation systems - Redundant stations, recommended preferred types

AS 412-3-2H automation system with SIMATIC PCS 7

AS Runtime license for 100 POs

Preassembled and tested, without CP 443-5 Extended, comprising:

2 x CPU 412-3H with 2 x 1 integrated interface (MPI/DP master), 2 x 768 KB main memory (512 KB each for program and 256 KB each for data), two CP 443-1 communications processors for connection to Industrial Ethernet plant bus as well as

- Aluminium UR2-H rack (2 x 9 slots), 4 sync modules for distances up to 10 m and 2 fiber-optic sync cables, 1 m
 - Two PS 407 power supplies; 10 A for 120/230 V AC/DC, redundant design, without backup batteries, 2 memory cards of 2 MB RAM each
 - Two PS 405 power supplies; 10 A for 24 V DC, without backup batteries, 2 memory cards of 2 MB RAM each

6ES7 656-8BA31-1CB0 B)

6ES7 656-8BA31-1GB0 B)

B) Subject to export regulations: AL: N, ECCN: EAR99H

Selection and Ordering Data	Order No.	Selection and Ordering Data	Order No.
<p>AS 414-4-2H automation system with SIMATIC PCS 7 AS Runtime license for 100 POs Preassembled and tested, without CP 443-5 Extended, comprising:</p> <p>2 x CPU 414-4H with 2 x 2 integrated interfaces (MPI/DP master and DP master), 2 x 2.8 MB main memory (1.4 MB each for program and data), 2 x CP 443-1 communications processors for connection to Industrial Ethernet plant bus as well as</p> <ul style="list-style-type: none"> Aluminium UR2-H rack (2 x 9 slots), 4 sync modules for distances up to 10 m and 2 fiber-optic sync cables, 1 m - Two PS 407 power supplies; 10 A for 120/230 V AC/DC, redundant design, without backup batteries, 2 memory cards of 2 MB RAM each - Two PS 407 power supplies; 10 A for 120/230 V AC/DC, redundant design, without backup batteries, 2 memory cards of 4 MB RAM each - Two PS 405 power supplies; 10 A for 24 V DC, without backup batteries, 2 memory cards of 2 MB RAM each - Two PS 405 power supplies; 10 A for 24 V DC, without backup batteries, 2 memory cards of 4 MB RAM each 	<p>6ES7 656-8BE31-1CB0 B)</p> <p>6ES7 656-8CE31-1CB0 B)</p> <p>6ES7 656-8BE31-1GB0 B)</p> <p>6ES7 656-8CE31-1GB0 B)</p>	<p>AS 417-4-2H automation system with SIMATIC PCS 7 AS Runtime license for 100 POs Preassembled and tested, without CP 443-5 Extended, comprising:</p> <p>2 x CPU 417-4H with 2 x 2 integrated interfaces (MPI/DP master and DP master), 2 x 30 MB RAM (15 MB each for program and data), 2 x CP 443-1 communications processors for connection to Industrial Ethernet plant bus as well as</p> <ul style="list-style-type: none"> Aluminium UR2-H rack (2 x 9 slots), 4 sync modules for distances up to 10 m and 2 fiber-optic sync cables, 1 m - Two PS 407 power supplies; 10 A for 120/230 V AC/DC, redundant design, without backup batteries, 2 memory cards of 4 MB RAM each - Two PS 407 power supplies; 10 A for 120/230 V AC/DC, redundant design, without backup batteries, 2 memory cards of 8 MB RAM each - Two PS 407 power supplies; 10 A for 120/230 V AC/DC, redundant design, without backup batteries, 2 memory cards of 16 MB RAM each - Two PS 405 power supplies; 10 A for 24 V DC, without backup batteries, 2 memory cards of 4 MB RAM each - Two PS 405 power supplies; 10 A for 24 V DC, without backup batteries, 2 memory cards of 8 MB RAM each - Two PS 405 power supplies; 10 A for 24 V DC, without backup batteries, 2 memory cards of 16 MB RAM each 	<p>6ES7 656-8CM31-1CB0 B)</p> <p>6ES7 656-8DM31-1CB0 B)</p> <p>6ES7 656-8EM31-1CB0 B)</p> <p>6ES7 656-8CM31-1GB0 B)</p> <p>6ES7 656-8DM31-1GB0 B)</p> <p>6ES7 656-8EM31-1GB0 B)</p>

Runtime licenses for SIMATIC PCS 7 automation systems (can be added to existing licenses)

SIMATIC PCS 7 AS Runtime license

6 languages (German, English, French, Italian, Spanish, Chinese), executes in the engineering system with Windows XP Professional, floating license for 1 installation

Type of delivery:
License key disk, certificate of license, terms and conditions

- 100 POs
- 1,000 POs
- 10,000 POs

6ES7 653-2BA00-0XB5
6ES7 653-2BB00-0XB5
6ES7 653-2BC00-0XB5

B) Subject to export regulations: AL: N, ECCN: EAR99H

Automation systems

Fault-tolerant automation systems

Individual components

Selection and Ordering Data	Order No.
Individual components of the fault-tolerant SIMATIC PCS 7 automation systems	
CPU 412-3H RAM 768 KB (512 KB for program and 256 KB for data) Module occupies 2 slots	6ES7 412-3HJ14-0AB0 B)
CPU 414-4H RAM 2.8 MB (1.4 MB each for program and data) Module occupies 2 slots	6ES7 414-4HM14-0AB0 B)
CPU 417-4H RAM 30 MB (15 MB each for program and data) Module occupies 2 slots	6ES7 417-4HT14-0AB0 B)
Sync set For linking the two redundant 412-3H, 414-4H or 417-4H CPUs; for distances up to <ul style="list-style-type: none"> • 10 m, consisting of 4 sync modules for up to 10 m and 2 fiber-optic sync cables, 1 m each • 10 km, consisting of 4 sync modules for up to 10 km Note: please order fiber-optic sync cables (2 units) in the required length separately. 	6ES7 656-7XX30-0XX0 6ES7 656-7XX40-0XX0
Sync module For linking the two CPUs 412-3H, 414-4H or 417-4H; two modules required per CPU For distances of up to <ul style="list-style-type: none"> • 10 m • 10 km 	6ES7 960-1AA04-0XA0 6ES7 960-1AB04-0XA0
Sync cable (fiber-optic cable) For connecting the two 412-3H, 414-4H or 417-4H CPUs; each redundant automation system requires 2 cables <ul style="list-style-type: none"> • 1 m • 2 m • 10 m Other lengths	6ES7 960-1AA04-5AA0 6ES7 960-1AA04-5BA0 6ES7 960-1AA04-5KA0 auf Anfrage
Memory Card RAM <ul style="list-style-type: none"> • 1 MB • 2 MB • 4 MB • 8 MB • 16 MB • 64 MB 	6ES7 952-1AK00-0AA0 6ES7 952-1AL00-0AA0 6ES7 952-1AM00-0AA0 6ES7 952-1AP00-0AA0 6ES7 952-1AS00-0AA0 6ES7 952-1AY00-0AA0
Memory Card Flash-EPROM Only required to update firmware. Alternative: firmware update via the engineering system <ul style="list-style-type: none"> • 8 MB 	6ES7 952-1KP00-0AA0

Selection and Ordering Data	Order No.
CP 443-1 Communications processor for connection of SIMATIC S7-400 to Industrial Ethernet through TCP/IP, ISO and UDP; for S7 communication, S5-compatible communication (SEND/RECEIVE) with FETCH/WRITE with or without RFC 1006, diagnostics expansion, Multicast, commissioning through LAN 10/100 Mbit/s, with electronic manual on CD-ROM	6GK7 443-1EX11-0XE0
CP 443-5 Extended Communications processor for connection of SIMATIC S7-400 to PROFIBUS as DP master or for S7 communication, for increasing the number of DP lines, for data set routing with SIMATIC PDM and for 10-ms time stamp, electronic manual on CD; module occupies 1 slot	6GK7 443-5DX04-0XE0
PS 407 power supply module; 10 A 120/230 V AC/DC; 5 V DC/10 A, 24 V DC/1 A; with battery compartment for 2 backup batteries, module occupies 2 slots	6ES7 407-0KA02-0AA0
PS 407 power supply module; 10 A, redundant design 120/230 V AC/DC; 5 V DC/10 A, 24 V DC/1 A; with battery compartment for 2 backup batteries, module occupies 2 slots	6ES7 407-0KR02-0AA0
PS 407 power supply module; 20 A 120/230 V AC/DC; 5 V DC/20 A, 24 V DC/1 A; with battery compartment for 2 backup batteries, module occupies 2 slots	6ES7 407-0RA02-0AA0
PS 405 power supply module; 10 A 24 V DC; 5 V DC/10 A, 24 V DC/1 A; with battery compartment for 2 backup batteries, module occupies 2 slots	6ES7 405-0KA02-0AA0
PS 405 power supply module; 10 A, redundant design 24 V DC; 5 V DC/10 A, 24 V DC/1 A; with battery compartment for 2 backup batteries, module occupies 2 slots	6ES7 405-0KR02-0AA0 B)
PS 405 power supply module; 20 A 24 V DC; 5 V DC/20 A, 24 V DC/1 A; with battery compartment for 2 backup batteries, module occupies 2 slots	6ES7 405-0RA02-0AA0
Backup battery Type AA, 2.3 Ah	6ES7 971-0BA00

B) Subject to export regulations: AL: N, ECCN: EAR99H

Selection and Ordering Data	Order No.
Aluminum UR1 rack 18 slots	6ES7 400-1TA11-0AA0 B)
Aluminum UR2 rack 9 slots	6ES7 400-1JA11-0AA0
Aluminum UR2-H rack For divided central controllers; 2 x 9 slots	6ES7 400-2JA10-0AA0
Steel UR1 rack 18 slots	6ES7 400-1TA01-0AA0
Steel UR2 rack 9 slots	6ES7 400-1JA01-0AA0
Steel UR2-H rack For divided central controllers; 2 x 9 slots	6ES7 400-2JA00-0AA0
Y-Link	
Y-Link For connection of devices with only one PROFIBUS DP interface to a fault-tolerant automation sys- tem	6ES7 197-1LA11-0XA0 B)

B) Subject to export regulations: AL: N, ECCN: EAR99H

Options

Y-Link

- Bus coupler for transition from a redundant PROFIBUS DP master system to a single-channel PROFIBUS DP master system
- For connecting devices with only one PROFIBUS DP interface to the redundant PROFIBUS DP master system AS 412H / AS 414H / AS 417H

The Y-link comprises:

- Two IM 153-2 High Feature interface modules for extended temperature range
- One Y-coupler incl. RS 485 repeater
- One IM157 (IM/IM) bus module for two IM 153-2 High Feature modules, for extended temperature range
- One BM Y-coupler bus module

Evaluation of the Y-Link diagnostics (and hence indirectly of the connected DP standard slaves) is supported by driver blocks.

Automation systems

Safety-related automation systems

Overview

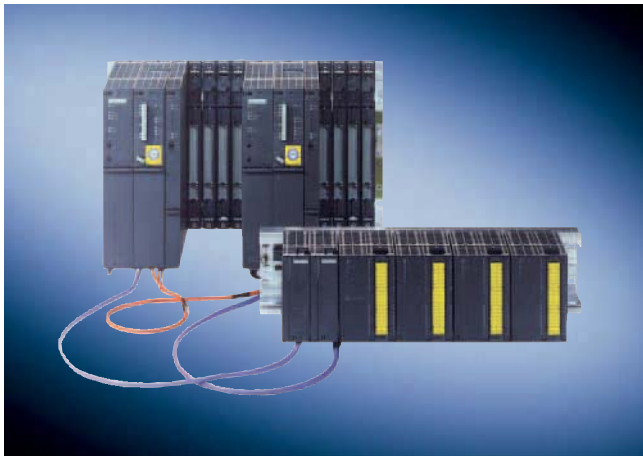

Safety-related automation systems are used for critical applications where a fault could endanger life or result in damage to the plant or the environment. These F/FH systems frequently referred to as "fail-safe automation systems" detect both faults in the process and their own internal faults in association with the safety-related F modules of the ET 200 distributed I/O systems or fail-safe transmitters connected directly via the fieldbus. They automatically transfer the plant to a safe state in the event of a fault.

Design

In general, two design versions are differentiated across all architectural levels of a system based on Safety Integrated for Process Automation:

- Single-channel, non-redundant design
- Redundant, fault-tolerant design

These two design versions are highly variable and offer a wide scope for design with regard to different customer requirements. Standard (basic process control) and safety-related functions can be combined flexibly, not only in the area of distributed I/O.

Even at the controller level, they can be combined in one system or separated. In addition, there are numerous possibilities arising from the use of flexible modular redundancy.

At the individual architectural levels (controller, fieldbus, distributed I/O) the configuration alternatives shown in the figure are available depending on the distributed I/O used (ET 200M and ET 200S remote I/O stations or PROFIBUS PA devices according to Profile 3.0).

Single-channel, non-redundant configuration

Distributed I/O and direct fieldbus interfacing

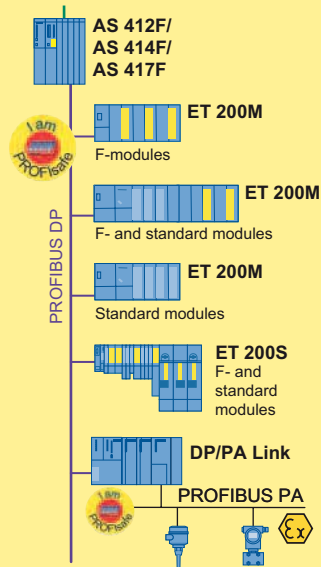

Redundant, high-availability and fault-tolerant configuration

Distributed I/O

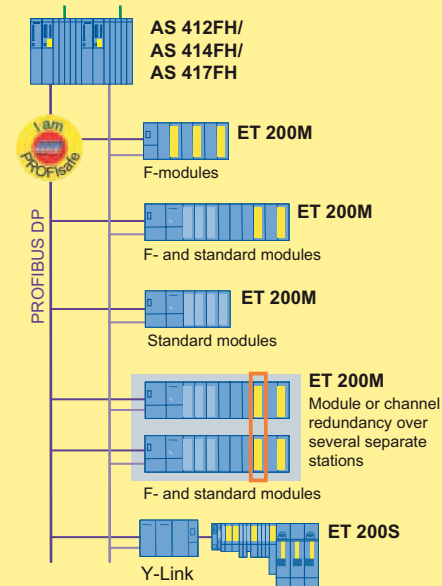

Direct fieldbus interfacing

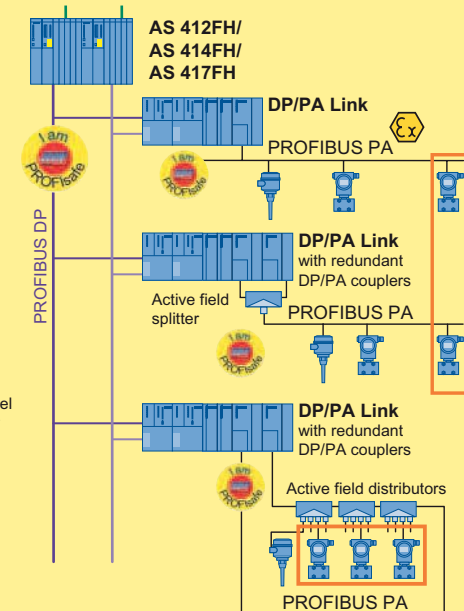

Flexible Modular Redundancy at module or device level

Design versions for safety-related systems

Safety-related automation systems

The safety-related SIMATIC PCS 7 automation systems at the controller level are categorized in accordance with the two design versions as follows:

- **Single stations**
AS 412F, AS 414F and AS 417F with only one CPU (safety-related)
- **Redundant stations**
AS 412FH, AS 414FH and AS 417FH with two redundant CPUs (safety-related and fault-tolerant)

Single stations and redundant stations are available as pre-assembled and tested all-in-one systems (AS bundles) without extra charge. They are based on the hardware of the AS 412H, AS 414H or AS 417H fault-tolerant automation systems expanded by safety functions with S7 F Systems.

Similar to the fault-tolerant systems used as a basis, the RAM of the safety-related AS bundles varies as follows:

AS type	RAM
AS 412F/FH	768 KB (512 KB for program and 256 KB for data)
AS 414F/FH	2.8 MB (1.4 MB each for program and data)
AS 417F/FH	30 MB (15 MB each for program and data)

All F/FH systems are TÜV-certified and comply with the safety requirements up to SIL 3 according to IEC 61508.

In the systems with multitasking capability, several programs can be executed simultaneously in one CPU – basic process control (BPCS) applications or also safety-related applications. The programs are reaction-free, i.e. faults in BPCS applications have no effect on safety-related applications, and vice versa. Special tasks with very short response times can also be implemented.

The redundant FH systems operating according to the 1-out-of-2 principle consist of two subsystems of identical design. These are electrically isolated from each other to achieve optimum EMC, and are synchronized with each other via fiber-optic cables. A bumpless switchover is made from the active subsystem to the standby subsystem in the event of a fault. The two subsystems can be present in the same rack or separated by up to 10 km. The spatial separation provides additional security in the case of extreme influences in the environment of the active subsystem, e.g. resulting from a fire.

The redundancy of the FH systems is only used to increase the availability. It is not relevant to processing of the safety functions and the associated fault detection.

Runtime licenses

Each AS bundle is already provided as standard with the SIMATIC PCS 7 AS Runtime license for 100 process objects (PO). The number of process objects can be extended by additional Runtime licenses for 100, 1000 or 10000 POs. The process objects of additional Runtime licenses can be added to process objects which already exist. The number and type (e.g. 100 or 1000) of additional Runtime licenses are irrelevant. The AS Runtime licenses are administered on a SIMATIC PCS 7 engineering system or in the SIMATIC PCS 7 BOX.

Communication over the plant bus

The safety-related automation systems are connected as standard to the plant bus using one communications processor per AS (F-systems) or sub-AS (FH-systems).

The plant bus can be implemented in the form of a ring structure, which can also be configured with redundant architecture if the availability requirements are high. When there are two redundant rings it makes sense to use two communications processors per AS (F-systems) or sub-AS (FH-systems) and to distribute their connections between the two rings (4-way connection). Double faults such as failure of the OSM/SCALANCE switch on ring 1 with simultaneous interruption in the bus cable on ring 2 can thus be tolerated.

Individual configuration of AS bundles

The equipment of the safety-related automation systems as well as their Order Nos. can be individually compiled by selecting preconfigured ordering units. System-specific ordering configurations are available for this purpose in the following Section "Selection and ordering data".

These are divided into:

- Single stations: AS 412F, AS 414F and AS 417F with only one CPU
- Redundant stations: AS 412FH, AS 414FH and AS 417FH with two redundant CPUs, mounted on one common rack (UR2-H) or two separate racks (UR2)

In order to rapidly access the recommended preferred configurations, these are additionally listed with their complete order numbers.

As an alternative to the ordering data in this catalog, the configurator offered in the catalog & online ordering system "A&D Mall" (www.siemens.com/automation/mall) can also be used to select and order safety-related automation systems for SIMATIC PCS 7.

Ordering information

The AS 412F/FH automation systems currently only support sync modules with a range up to 10 m. Fiber-optic sync cables longer than 1 m must always be ordered separately (2 of each required).

Automation systems

Safety-related automation systems

Function

Safety functions

The safety functions of an application are implemented by the safety-related program executed in the CPU of the F/FH systems together with the safety-related F-modules of the ET 200 distributed I/O systems or directly by failsafe transmitters connected via the fieldbus.

The PROFIsafe profile is used for the safe PROFIBUS DP communication between CPU and process I/O. PROFIsafe expands the message frames by additional information with which the PROFIsafe communications partners can recognize and compensate transmission errors such as delays, incorrect sequences, repetitions, losses, faulty addressing or data falsification.

Standard modules can be used in F/FH systems in addition to safety-related F-modules - mixed in a remote I/O station or in separate stations, in a common PROFIBUS segment or in separate PROFIBUS segments. Basic process control (BPCS) applications and safety applications can be automated in such mixed configurations with one and the same system and configured with uniform standard tools.

One CPU processes BPCS and safety functions in parallel. Mutual interference during processing is prevented by ensuring that the BPCS programs and the safety-related programs are kept strictly separate and that the data exchange is by means of special conversion function blocks. The safety functions are processed twice in different sections of a CPU by means of redundant, diverse instruction processing. Potential errors are detected by the system during the subsequent comparison of results.

The S7 F Systems engineering tool as a component of the SIMATIC Manager allows parameterization of the F/FH systems and the safety-related F-modules from the ET 200 series. It supports configuration by means of functions for:

- Comparison of safety-related F-programs
- Recognition of changes in the F-program using the checksum
- Separation of safety-related and standard functions.

Access to the F-functions can be password-protected.

The F-block library integrated in S7 F Systems contains pre-defined function blocks for generation of safety-related applications with the CFC or the SIMATIC Safety Matrix based on it. The certified F-blocks are extremely robust and intercept programming errors such as division by zero or out-of-range values. They avoid the need for diverse programming tasks for detecting and reacting to errors.

Options

Ordering information

An AS 412H, AS 414H or AS 417H system is required as the hardware for a safety-related automation system.

The following H systems can be used depending on the type and structure of the safety-related automation system:

- For single-channel AS 412F, AS 414F or AS 417F safety-related systems: one each of AS 412-3-1H, AS 414-4-1H or AS 417-4-1H
- For fault-tolerant and safety-related AS 412FH, AS 414FH or AS 417FH systems:
 - With both subsystems in one rack: one each of AS 412-3-2H, AS 414-4-2H or AS 417-4-2H
 - With the two subsystems in different racks: two each of AS 412-3-1H, AS 414-4-1H or AS 417-4-1H

You require the following components in addition:

- S7 F Systems
F programming tool with F block library for programming safety-related user programs on the engineering system (see Chapter "Engineering system")
- F Runtime license
For processing safety-related user programs, for one AS 412F/FH, AS 414F/FH or AS 417F/FH system
- Option: SIMATIC Safety Matrix
The convenient safety lifecycle tool for configuration of operation and servicing (see Chapter "Engineering system")

Safety-related automation systems

Selection and ordering data	Order No.
AS 412F (Single Station) with SIMATIC PCS 7 AS Runtime license for 100 POs CPU with 1 interface (MPI/DP master) 768 KB RAM (512 KB for program and 256 KB for data)	6ES7 654-
Type of delivery	
• Preassembled and tested	8
Memory card	
• Memory card 1 MB RAM (up to approx. 50 POs)	A
• Memory card 2 MB RAM (up to approx. 180 POs)	B
CPU type	
• CPU 412-3H with S7 F Systems RT license (up to approx. 50 POs)	B
Additive interface modules	
• Without additive interface module	0
Interface module to Industrial Ethernet plant bus¹⁾	
• 1 x CP 443-1 ¹⁾	1
• 2 x CP 443-1 for redundant interface module ¹⁾	2
Rack	
• UR2 (9 slots), aluminum	3
• UR2 (9 slots), steel	4
• UR1 (18 slots), aluminum	5
• UR1 (18 slots), steel	6
Power supply (without backup batteries)	
• 1 x PS 407, 10 A for 120/230 V AC/DC	B
• 1 x PS 407, 10 A for 120/230 V AC/DC, redundancy possible	C
• 1 x PS 407, 20 A for 120/230 V AC/DC	D
• 2 x PS 407, 10 A for 120/230 V AC/DC, redundancy possible	E
• 1 x PS 405, 10 A for 24 V DC	G
• 1 x PS 405, 10 A for 24 V DC, redundancy possible	H
• 1 x PS 405, 20 A for 24 V DC	J
• 2 x PS 405, 10 A for 24 V DC, redundancy possible	K
Additive PROFIBUS DP interface modules¹⁾	
• Without CP 443-5 Extended	0
• 1 x CP 443-5 Extended	1
• 2 x CP 443-5 Extended ¹⁾	2
• 3 x CP 443-5 Extended ¹⁾	3
• 4 x CP 443-5 Extended ¹⁾	4

¹⁾ Up to 5 CPs can be plugged into the UR2 rack with a single power supply, or up to 3 with a redundant power supply.

Selection and ordering data	Order No.
AS 414F (Single Station) with SIMATIC PCS 7 AS Runtime license for 100 POs CPU with 2 interfaces (MPI/DP master and DP master) 2.8 MB RAM (1.4 MB each for program and data)	6ES7 654-
Type of delivery	
• Preassembled and tested	8
Memory card	
• Memory card 2 MB RAM (up to approx. 180 POs)	B
• Memory card 4 MB RAM (up to approx. 300 POs)	C
CPU type	
• CPU 414-4H with S7 F Systems RT license (up to approx. 250 POs)	F
Additive interface modules	
• Without additive interface module	0
Interface module to Industrial Ethernet plant bus¹⁾	
• 1 x CP 443-1 ¹⁾	1
• 2 x CP 443-1 for redundant interface module ¹⁾	2
Rack	
• UR2 (9 slots), aluminum	3
• UR2 (9 slots), steel	4
• UR1 (18 slots), aluminum	5
• UR1 (18 slots), steel	6
Power supply (without backup batteries)	
• 1 x PS 407, 10 A for 120/230 V AC/DC	B
• 1 x PS 407, 10 A for 120/230 V AC/DC, redundancy possible	C
• 1 x PS 407, 20 A for 120/230 V AC/DC	D
• 2 x PS 407, 10 A for 120/230 V AC/DC, redundancy possible	E
• 1 x PS 405, 10 A for 24 V DC	G
• 1 x PS 405, 10 A for 24 V DC, redundancy possible	H
• 1 x PS 405, 20 A for 24 V DC	J
• 2 x PS 405, 10 A for 24 V DC, redundancy possible	K
Additive PROFIBUS DP interface modules¹⁾	
• Without CP 443-5 Extended	0
• 1 x CP 443-5 Extended	1
• 2 x CP 443-5 Extended ¹⁾	2
• 3 x CP 443-5 Extended ¹⁾	3
• 4 x CP 443-5 Extended ¹⁾	4

¹⁾ Up to 5 CPs can be plugged into the UR2 rack with a single power supply, or up to 3 with a redundant power supply.

Automation systems

Safety-related automation systems

Selection and ordering data	Order No.
AS 417F (Single Station) with SIMATIC PCS 7 AS Runtime license for 100 POs CPU with 2 interfaces (MPI/DP master and DP master) 30 MB RAM (15 MB each for program and data)	6ES7 654-
Type of delivery	
• Preassembled and tested	8
Memory card	
• Memory card 4 MB RAM (up to approx. 300 POs)	C
• Memory card 8 MB RAM (up to approx. 800 POs)	D
• Memory card 16 MB RAM (up to approx. 3,000 POs)	E
CPU type	
• CPU 417-4H with S7 F Systems RT license (up to approx. 2,500 POs)	N
Additive interface modules	
• Without additive interface module	0
• 1 x IF 964-DP	1
Interface module to Industrial Ethernet plant bus¹⁾	
• 1 x CP 443-1 ¹⁾	1
• 2 x CP 443-1 for redundant interface module ¹⁾	2
Rack	
• UR2 (9 slots), aluminum	3
• UR2 (9 slots), steel	4
• UR1 (18 slots), aluminum	5
• UR1 (18 slots), steel	6
Power supply (without backup batteries)	
• 1 x PS 407, 10 A for 120/230 V AC/DC	B
• 1 x PS 407, 10 A for 120/230 V AC/DC, redundancy possible	C
• 1 x PS 407, 20 A for 120/230 V AC/DC	D
• 2 x PS 407, 10 A for 120/230 V AC/DC, redundancy possible	E
• 1 x PS 405, 10 A for 24 V DC	G
• 1 x PS 405, 10 A for 24 V DC, redundancy possible	H
• 1 x PS 405, 20 A for 24 V DC	J
• 2 x PS 405, 10 A for 24 V DC, redundancy possible	K
Additive PROFIBUS DP interface modules¹⁾	
• Without CP 443-5 Extended	0
• 1 x CP 443-5 Extended	1
• 2 x CP 443-5 Extended ¹⁾	2
• 3 x CP 443-5 Extended ¹⁾	3
• 4 x CP 443-5 Extended ¹⁾	4

¹⁾ Up to 5 CPs can be plugged into the UR2 rack with a single power supply, or up to 3 with a redundant power supply.

Selection and ordering data	Order No.
AS 412FH (Redundant Station) with SIMATIC PCS 7 AS Runtime license for 100 POs 2 x CPU with 1 interface each (MPI/DP master) 2 x 768 KB RAM (512 KB each for program and 256 KB each for data)	6ES7 656-
Type of delivery	
• Preassembled and tested	8
Memory card	
• 2 x memory card 1 MB RAM (up to approx. 50 POs)	A
• 2 x memory card 2 MB RAM (up to approx. 180 POs)	B
CPU type	
• 2 x CPU 412-3H with S7 F Systems RT license (up to approx. 50 POs)	B
Sync modules and cables	
• 2 x 2 sync modules for distances up to 10 m and 2 x FO sync cable, 1 m	3
Interface module to Industrial Ethernet plant bus¹⁾	
• 2 x CP 443-1 for redundant interface module ¹⁾	1
• 2 x 2 CP 443-1 for 4-way connection ¹⁾	2
Rack	
• 1 x UR2-H (2 x 9 slots), aluminum	1
• 1 x UR2-H (2 x 9 slots), steel	2
• 2 x UR2 (9 slots), aluminum	3
• 2 x UR2 (9 slots), steel	4
Power supply (without backup batteries)	
• 2 x PS 407, 10 A for 120/230 V AC/DC	B
• 2 x PS 407, 10 A for 120/230 V AC/DC, redundancy possible	C
• 2 x PS 407, 20 A for 120/230 V AC/DC	D
• 2 x 2 PS 407, 10 A for 120/230 V AC/DC, redundancy possible	E
• 2 x PS 405, 10 A for 24 V DC	G
• 2 x PS 405, 10 A for 24 V DC, redundancy possible,	H
• 2 x PS 405, 20 A for 24 V DC	J
• 2 x PS 405, 10 A for 24 V DC, redundancy possible	K
Additive PROFIBUS DP interface modules¹⁾	
• Without CP 443-5 Extended	0
• 2 x CP 443-5 Extended	1
• 2 x 2 CP 443-5 Extended ¹⁾	2
• 2 x 3 CP 443-5 Extended ¹⁾	3
• 2 x 4 CP 443-5 Extended ¹⁾	4

¹⁾ Up to 5 CPs can be plugged in per subsystem with a single power supply, or up to 3 with a redundant power supply.

Safety-related automation systems

Selection and ordering data	Order No.
AS 414FH (Redundant Station) with SIMATIC PCS 7 AS Runtime license for 100 POs 2 x CPU with 2 interfaces (MPI/DP master and DP master) 2 x 2.8 MB RAM (1.4 MB each for program and data)	6ES7 656-
Type of delivery	
• Preassembled and tested	8
Memory card	
• 2 x memory card 2 MB RAM (up to approx. 180 POs)	B
• 2 x memory card 4 MB RAM (up to approx. 300 POs)	C
CPU type	
• 2 x CPU 414-4H with S7 F Systems RT license (up to approx. 250 POs)	F
Sync modules and cables	
• 2 x 2 sync modules for distances up to 10 m and 2 x FO sync cable, 1 m	3
• 2 x 2 sync modules for up to 10 km and 2 x FO sync cable, 1 m, for testing	4
Interface module to Industrial Ethernet plant bus¹⁾	
• 2 x CP 443-1 for redundant interface module ¹⁾	1
• 2 x 2 CP 443-1 for 4-way connection ¹⁾	2
Rack	
• 1 x UR2-H (2 x 9 slots), aluminum	1
• 1 x UR2-H (2 x 9 slots), steel	2
• 2 x UR2 (9 slots), aluminum	3
• 2 x UR2 (9 slots), steel	4
Power supply (without backup batteries)	
• 2 x PS 407, 10 A for 120/230 V AC/DC	B
• 2 x PS 407, 10 A for 120/230 V AC/DC, redundancy possible	C
• 2 x PS 407, 20 A for 120/230 V AC/DC	D
• 2 x 2 PS 407, 10 A for 120/230 V AC/DC, redundancy possible	E
• 2 x PS 405, 10 A for 24 V DC	G
• 2 x PS 405, 10 A for 24 V DC, redundancy possible	H
• 2 x PS 405, 20 A for 24 V DC	J
• 2 x PS 405, 10 A for 24 V DC, redundancy possible	K
Additive PROFIBUS DP interface modules¹⁾	
• Without CP 443-5 Extended	0
• 2 x CP 443-5 Extended	1
• 2 x 2 CP 443-5 Extended ¹⁾	2
• 2 x 3 CP 443-5 Extended ¹⁾	3
• 2 x 4 CP 443-5 Extended ¹⁾	4

¹⁾ Up to 5 CPs can be plugged in per subsystem with a single power supply, or up to 3 with a redundant power supply.

Selection and ordering data	Order No.
AS 417FH (Redundant Station) with SIMATIC PCS 7 AS Runtime license for 100 POs 2 x CPU with 2 interfaces (MPI/DP master and DP master) 2 x 30 MB RAM (15 MB each for program and data)	6ES7 656-
Type of delivery	
• Preassembled and tested	8
Memory card	
• 2 x memory card 4 MB RAM (up to approx. 300 POs)	C
• 2 x memory card 8 MB RAM (up to approx. 800 POs)	D
• 2 x memory card 16 MB RAM (up to approx. 3,000 POs)	E
CPU type	
• 2 x CPU 417-4H with S7 F Systems RT license (up to approx. 2,500 POs)	N
Sync modules and cables	
• 2 x 2 sync modules for distances up to 10 m and 2 x FO sync cable, 1 m	3
• 2 x 2 sync modules for up to 10 km and 2 x FO sync cable, 1 m, for testing	4
Interface module to Industrial Ethernet plant bus¹⁾	
• 2 x CP 443-1 for redundant interface module ¹⁾	1
• 2 x 2 CP 443-1 for 4-way connection ¹⁾	2
Rack	
• 1 x UR2-H (2 x 9 slots), aluminum	1
• 1 x UR2-H (2 x 9 slots), steel	2
• 2 x UR2 (9 slots), aluminum	3
• 2 x UR2 (9 slots), steel	4
Power supply (without backup batteries)	
• 2 x PS 407, 10 A for 120/230 V AC/DC	B
• 2 x PS 407, 10 A for 120/230 V AC/DC, redundancy possible	C
• 2 x PS 407, 20 A for 120/230 V AC/DC	D
• 2 x 2 PS 407, 10 A for 120/230 V AC/DC, redundancy possible	E
• 2 x PS 405, 10 A for 24 V DC	G
• 2 x PS 405, 10 A for 24 V DC, redundancy possible	H
• 2 x PS 405, 20 A for 24 V DC	J
• 2 x PS 405, 10 A for 24 V DC, redundancy possible	K
Additive PROFIBUS DP interface modules¹⁾	
• Without CP 443-5 Extended	0
• 2 x CP 443-5 Extended	1
• 2 x 2 CP 443-5 Extended ¹⁾	2
• 2 x 3 CP 443-5 Extended ¹⁾	3
• 2 x 4 CP 443-5 Extended ¹⁾	4

¹⁾ Up to 5 CPs can be plugged in per subsystem with a single power supply, or up to 3 with a redundant power supply.

Automation systems

Safety-related automation systems

Recommended preferred types

Selection and Ordering Data

Order No.

Safety-related SIMATIC PCS 7 automation systems - Single Stations, recommended preferred types

AS 412F automation system with SIMATIC PCS 7

AS Runtime license for 100 POs

Preassembled and tested, without CP 443-5 Extended, without sync modules and cables, comprising:

1 x CPU 412-3H with one integrated interface (MPI/DP master) and S7 F Systems RT license, 768 KB RAM (512 KB for program and 256 KB for data) as well as

- UR2 aluminum rack (9 slots)
- PS 407 power supply; 10 A for 120/230 V AC/DC, without backup batteries, memory card 1 MB RAM, 1 x CP 443-1 communications processor for connection to plant bus
- PS 407 power supply; 10 A for 120/230 V AC/DC, without backup batteries, memory card 1 MB RAM, 2 x CP 443-1 communications processor for connection to plant bus
- PS 405 power supply; 10 A for 24 V DC, without backup batteries, memory card 1 MB RAM, 1 x CP 443-1 communications processor for connection to plant bus
- PS 405 power supply; 10 A for 24 V DC, without backup batteries, memory card 1 MB RAM, 2 x CP 443-1 communications processor for connection to plant bus

6ES7 654-8AB01-3BB0 B)

6ES7 654-8AB02-3BB0 B)

6ES7 654-8AB01-3GB0 B)

6ES7 654-8AB02-3GB0 B)

Selection and Ordering Data

Order No.

AS 414F automation system with SIMATIC PCS 7

AS Runtime license for 100 POs

Preassembled and tested, without CP 443-5 Extended, without sync modules and cables, comprising:

1 x CPU 414-4H with 2 integrated interfaces (MPI/DP master and DP master) and S7 F Systems RT license, 2.8 MB RAM (1.4 MB each for program and data) as well as

- UR2 aluminum rack (9 slots)
- PS 407 power supply; 10 A for 120/230 V AC/DC, without backup batteries, memory card 4 MB RAM, 1 x CP 443-1 communications processor for connection to plant bus
- PS 407 power supply; 10 A for 120/230 V AC/DC, without backup batteries, memory card 4 MB RAM, 2 x CP 443-1 communications processor for connection to plant bus
- PS 405 power supply; 10 A for 24 V DC, without backup batteries, memory card 4 MB RAM, 1 x CP 443-1 communications processor for connection to plant bus
- PS 405 power supply; 10 A for 24 V DC, without backup batteries, memory card 4 MB RAM, 2 x CP 443-1 communications processor for connection to plant bus

6ES7 654-8CF01-3BB0 B)

6ES7 654-8CF02-3BB0 B)

6ES7 654-8CF01-3GB0 B)

6ES7 654-8CF02-3GB0 B)

B) Subject to export regulations: AL: N, ECCN: EAR99H

Selection and Ordering Data	Order No.
<p>AS 417F automation system with SIMATIC PCS 7 AS Runtime license for 100 POs Preassembled and tested, without CP 443-5 Extended, without sync modules and cables, comprising:</p> <ul style="list-style-type: none"> 1 x CPU 417-4H with 2 integrated interfaces (MPI/DP master and DP master) and S7 F Systems RT license, 30 MB RAM (15 MB each for program and data) as well as • UR2 aluminum rack (9 slots) <ul style="list-style-type: none"> - PS 407 power supply; 10 A for 120/230 V AC/DC, without backup batteries, memory card 16 MB RAM, 1 x CP 443-1 communications processor for connection to plant bus - PS 407 power supply; 10 A for 120/230 V AC/DC, without backup batteries, memory card 16 MB RAM, 2 x CP 443-1 communications processor for connection to plant bus - PS 405 power supply; 10 A for 24 V DC, without backup batteries, memory card 16 MB RAM, 1 x CP 443-1 communications processor for connection to plant bus - PS 405 power supply; 10 A for 24 V DC, without backup batteries, memory card 16 MB RAM, 2 x CP 443-1 communications processor for connection to plant bus 	<p>6ES7 654-8EN01-3BB0 B)</p> <p>6ES7 654-8EN02-3BB0 B)</p> <p>6ES7 654-8EN01-3GB0 B)</p> <p>6ES7 654-8EN02-3GB0 B)</p>

Selection and Ordering Data	Order No.
<p><i>Safety-related SIMATIC PCS 7 automation systems - Redundant Stations, recommended preferred types</i></p> <p>AS 412FH automation system with SIMATIC PCS 7 AS Runtime license for 100 POs Preassembled and tested, without CP 443-5 Extended, comprising:</p> <ul style="list-style-type: none"> 2 x CPU 412-3H, each with integrated interface (MPI/DP master) and S7 F Systems RT license, 2 x 768 KB RAM (512 KB each for program and 256 KB each for data) as well as • Aluminium UR2-H rack (2 x 9 slots), 4 sync modules for distances up to 10 m and 2 fiber-optic sync cables, 1 m <ul style="list-style-type: none"> - 2 x 2 PS 407 power supplies; 10 A for 120/230 V AC/DC, redundancy possible, without backup batteries, 2 memory cards with 1 MB RAM each, 2 x CP 443-1 communications processor for connection to plant bus - 2 x 2 PS 407 power supplies; 10 A for 120/230 V AC/DC, redundancy possible, without backup batteries, 2 memory cards with 1 MB RAM each, 2 x 2 CP 443-1 communications processors for connection to plant bus - 2 PS 405 power supplies; 10 A for 24 V DC, without backup batteries, 2 memory cards with 1 MB RAM each, 2 x CP 443-1 communications processors for connection to plant bus - 2 PS 405 power supplies; 10 A for 24 V DC, without backup batteries, 2 memory cards with 1 MB RAM each, 2 x 2 CP 443-1 communications processors for connection to plant bus 	<p>6ES7 656-8AB31-1EB0 B)</p> <p>6ES7 656-8AB32-1EB0 B)</p> <p>6ES7 656-8AB31-1GB0 B)</p> <p>6ES7 656-8AB32-1GB0 B)</p>

B) Subject to export regulations: AL: N, ECCN: EAR99H

Automation systems

Safety-related automation systems

Selection and Ordering Data

Order No.

AS 414FH automation system with SIMATIC PCS 7

AS Runtime license for 100 POs

Preassembled and tested, without CP 443-5 Extended, comprising:

2 x CPU 414-4H, each with 2 integrated interfaces (MPI/DP master and DP master) and S7 F Systems RT license, 2 x 2.8 MB RAM (1.4 MB each for program and data) as well as

- Aluminium UR2-H rack (2 x 9 slots), 4 sync modules for distances up to 10 m and 2 fiber-optic sync cables, 1 m

- 2 x 2 PS 407 power supplies; 10 A for 120/230 V AC/DC, redundancy possible, without backup batteries, 2 memory cards with 4 MB RAM each, 2 x CP 443-1 communications processor for connection to plant bus

6ES7 656-8CF31-1EB0 B)

- 2 x 2 PS 407 power supplies; 10 A for 120/230 V AC/DC, redundancy possible, without backup batteries, 2 memory cards with 4 MB RAM each, 2 x 2 CP 443-1 communications processors for connection to plant bus

6ES7 656-8CF32-1EB0 B)

- 2 PS 405 power supplies; 10 A for 24 V DC, without backup batteries, 2 memory cards with 4 MB RAM each, 2 x CP 443-1 communications processors for connection to plant bus

6ES7 656-8CF31-1GB0 B)

- 2 PS 405 power supplies; 10 A for 24 V DC, without backup batteries, 2 memory cards with 4 MB RAM each, 2 x 2 CP 443-1 communications processors for connection to plant bus

6ES7 656-8CF32-1GB0 B)

Selection and Ordering Data

Order No.

AS 417FH automation system with SIMATIC PCS 7

AS Runtime license for 100 POs

Preassembled and tested, without CP 443-5 Extended, comprising:

2 x CPU 417-4H, each with 2 integrated interfaces (MPI/DP master and DP master) and S7 F Systems RT license, 2 x 30 MB RAM (15 MB each for program and data) as well as

- Aluminium UR2-H rack (2 x 9 slots), 4 sync modules for distances up to 10 m and 2 fiber-optic sync cables, 1 m

- 2 x 2 PS 407 power supplies; 10 A for 120/230 V AC/DC, redundancy possible, without backup batteries, 2 memory cards with 16 MB RAM each, 2 x CP 443-1 communications processor for connection to plant bus

6ES7 656-8EN31-1EB0 B)

- 2 x 2 PS 407 power supplies; 10 A for 120/230 V AC/DC, redundancy possible, without backup batteries, 2 memory cards 16 MB RAM, 2 x 2 CP 443-1 communications processors for connection to plant bus

6ES7 656-8EN32-1EB0 B)

- 2 PS 405 power supplies; 10 A for 24 V DC, without backup batteries, 2 memory cards with 16 MB RAM each, 2 x CP 443-1 communications processors for connection to plant bus

6ES7 656-8EN31-1GB0 B)

- 2 PS 405 power supplies; 10 A for 24 V DC, without backup batteries, 2 memory cards with 16 MB RAM each, 2 x 2 CP 443-1 communications processors for connection to plant bus

6ES7 656-8EN32-1GB0 B)

Runtime licenses for SIMATIC PCS 7 automation systems (can be added to existing licenses)

SIMATIC PCS 7 AS Runtime license

6 languages (German, English, French, Italian, Spanish, Chinese), executes in the engineering system with Windows XP Professional, floating license for 1 installation

Type of delivery:
License key disk, certificate of license, terms and conditions

- 100 POs
- 1,000 POs
- 10,000 POs

6ES7 653-2BA00-0XB5

6ES7 653-2BB00-0XB5

6ES7 653-2BC00-0XB5

AS 412F/FH, AS 414F/FH and AS 417F/FH engineering (see Chapter "Engineering System", Section "Engineering Process Safety")

B) Subject to export regulations: AL: N, ECCN: EAR99H

Individual components

Selection and Ordering Data	Order No.
Individual components of the safety-related SIMATIC PCS 7 automation systems	
S7 F Systems RT License For processing safety-related application programs, for one AS 412F/FH, AS 414F/FH or AS 417F/FH system	6ES7 833-1CC00-6YX0
CPU 412-3H RAM 768 KB (512 KB for program and 256 KB for data) Module occupies 2 slots	6ES7 412-3HJ14-0AB0 B)
CPU 414-4H RAM 2.8 MB (1.4 MB each for program and data) Module occupies 2 slots	6ES7 414-4HM14-0AB0 B)
CPU 417-4H RAM 30 MB (15 MB each for program and data) Module occupies 2 slots	6ES7 417-4HT14-0AB0 B)
Sync set For linking the two redundant 412-3H, 414-4H or 417-4H CPUs; for distances up to	
<ul style="list-style-type: none"> 10 m, consisting of 4 sync modules for up to 10 m and 2 fiber-optic sync cables, 1 m each 	6ES7 656-7XX30-0XX0
<ul style="list-style-type: none"> 10 km, consisting of 4 sync modules for up to 10 km Note: please order fiber-optic sync cables (2 units) in the required length separately. 	6ES7 656-7XX40-0XX0
Sync module For linking the two 412-3H, 414-4H or 417-4H CPUs; two modules required per CPU For distances of up to	
<ul style="list-style-type: none"> 10 m 	6ES7 960-1AA04-0XA0
<ul style="list-style-type: none"> 10 km 	6ES7 960-1AB04-0XA0
Sync cable (fiber-optic cable) For connecting the two 412-3H, 414-4H or 417-4H CPUs; each redundant automation system requires 2 cables	
<ul style="list-style-type: none"> 1 m 2 m 10 m 	6ES7 960-1AA04-5AA0 6ES7 960-1AA04-5BA0 6ES7 960-1AA04-5KA0
Other lengths	auf Anfrage

Selection and Ordering Data	Order No.
Memory Card RAM	
<ul style="list-style-type: none"> 1 MB 2 MB 4 MB 8 MB 16 MB 64 MB 	6ES7 952-1AK00-0AA0 6ES7 952-1AL00-0AA0 6ES7 952-1AM00-0AA0 6ES7 952-1AP00-0AA0 6ES7 952-1AS00-0AA0 6ES7 952-1AY00-0AA0
Memory Card Flash-EPROM Only required to update firmware; alternative: firmware update via the engineering system	
<ul style="list-style-type: none"> 8 MB 	6ES7 952-1KP00-0AA0
CP 443-1 Communications processor for connection of SIMATIC S7-400 to Industrial Ethernet through TCP/IP, ISO and UDP; for S7 communication, S5-compatible communication (SEND/RECEIVE) with FETCH/WRITE with or without RFC 1006, diagnostics expansion, Multicast, commissioning through LAN 10/100 Mbit/s, with electronic manual on CD-ROM	6GK7 443-1EX11-0XE0
CP 443-5 Extended Communications processor for connection of SIMATIC S7-400 to PROFIBUS as DP master or for S7 communication, for increasing the number of DP lines, for data set routing with SIMATIC PDM and for 10-ms time stamp, electronic manual on CD; module occupies 1 slot	6GK7 443-5DX04-0XE0
PS 407 power supply module; 10 A 120/230 V AC/DC; 5 V DC/10 A, 24 V DC/1 A; with battery compartment for 2 backup batteries, module occupies 2 slots	6ES7 407-0KA02-0AA0
PS 407 power supply module; 10 A, redundant design possible 120/230 V AC/DC; 5 V DC/10 A, 24 V DC/1 A; with battery compartment for 2 backup batteries, module occupies 2 slots	6ES7 407-0KR02-0AA0

B) Subject to export regulations: AL: N, ECCN: EAR99H

Automation systems

Safety-related automation systems

Selection and Ordering Data	Order No.	Selection and Ordering Data	Order No.
PS 407 power supply module; 20 A 120/230 V AC/DC; 5 V DC/20 A, 24 V DC/1 A; with battery compartment for 2 backup batteries, module occu- pies 2 slots	6ES7 407-0RA02-0AA0	Aluminum UR1 rack 18 slots	6ES7 400-1TA11-0AA0 B)
PS 405 power supply module; 10 A 24 V DC; 5 V DC/10 A, 24 V DC/1 A; with battery compartment for 2 backup batteries, module occu- pies 2 slots	6ES7 405-0KA02-0AA0	Aluminum UR2 rack 9 slots	6ES7 400-1JA11-0AA0
PS 405 power supply module; 10 A, redundant design possi- ble 24 V DC; 5 V DC/10 A, 24 V DC/1 A; with battery compartment for 2 backup batteries, module occu- pies 2 slots	6ES7 405-0KR02-0AA0 B)	Aluminum UR2-H rack For divided central controllers; 2 x 9 slots	6ES7 400-2JA10-0AA0
PS 405 power supply module; 20 A 24 V DC; 5 V DC/20 A, 24 V DC/1 A; with battery compartment for 2 backup batteries, module occu- pies 2 slots	6ES7 405-0RA02-0AA0	Steel UR1 rack 18 slots	6ES7 400-1TA01-0AA0
Backup battery Type AA, 2.3 Ah	6ES7 971-0BA00	Steel UR2 rack 9 slots	6ES7 400-1JA01-0AA0
		Steel UR2-H rack For divided central controllers; 2 x 9 slots	6ES7 400-2JA00-0AA0

B) Subject to export regulations: AL: N, ECCN: EAR99H

Process I/O



11/2	Introduction	11/39	ET 200S distributed I/O
11/4	Central I/O	11/39	Introduction
11/4	Central I/O modules	11/41	Terminal modules
11/5	Expansion units for central I/O	11/43	Interface modules
11/6	SIMATIC PCS 7 MTA terminal module	11/44	Power modules
11/9	ET 200M distributed I/O	11/45	Digital electronics modules
11/9	Introduction	11/47	Analog electronics modules
11/10	Power supply	11/49	Motor starters
11/11	Interface modules	11/53	SIGUARD safety technology
11/12	ET 200M accessories	11/56	ET 200pro distributed I/O
11/13	Bundles	11/56	Introduction
11/14	DI - digital input modules	11/59	Interface module IM 154-2 DP High Feature
11/16	DO - digital output modules	11/60	Digital electronics modules EM 141, EM 142
11/18	DI/DO - digital input/output modules	11/61	Analog electronics modules EM 144, EM 145
11/19	AI - analog input modules	11/63	Safety-related electronics modules
11/21	AO - analog output modules	11/64	Power module PM-E
11/22	Ex modules [EEi xb]		
11/23	Modules with HART		
11/25	F modules		
11/27	Closed-loop control modules		
11/29	Counter modules		
11/30	ET 200iSP distributed I/O		
11/30	Introduction		
11/32	ET 200iSP power supply unit		
11/33	IM 152-1 interface module		
11/34	Electronics modules and watchdog module		
11/37	RS 485-IS coupler		
11/38	Stainless steel wall enclosure		



Process I/O

Introduction

Overview

The SIMATIC PCS 7 process control system offers various possibilities for connecting I/O devices and for detecting and emitting process signals through sensors and actuators:

- Analog and digital I/O modules of the SIMATIC S7-400 operated centrally in the automation system
- ET 200M, ET 200S, ET 200iSP and ET 200pro remote I/O stations with an extensive range of cost-effective signal and function modules, connected through PROFIBUS DP to the automation system (AS)
- Direct AS connection of intelligent, distributed field/process devices and operator terminals through PROFIBUS DP/PA (redundant or in hazardous zones 0, 1, 2 or 20, 21, 22 also possible)

Signal groups of the SIMATIC S7-400 can be operated centrally in the automation system and are mainly used in small applications or systems of limited distributed expansion.

Distributed process I/Os are mainly used nowadays: ET 200 remote I/Os in conjunction with classical field/process devices and HART field devices or intelligent field/process devices directly on PROFIBUS. Decisive for this are properties such as:

- Modularity and consistency
- Flexible adaptability to the plant structure
- Minimum cabling and engineering requirements
- Low commissioning, servicing and lifecycle costs
- Wide technical bandwidth

Design

Integration of I/O modules in the hazardous area

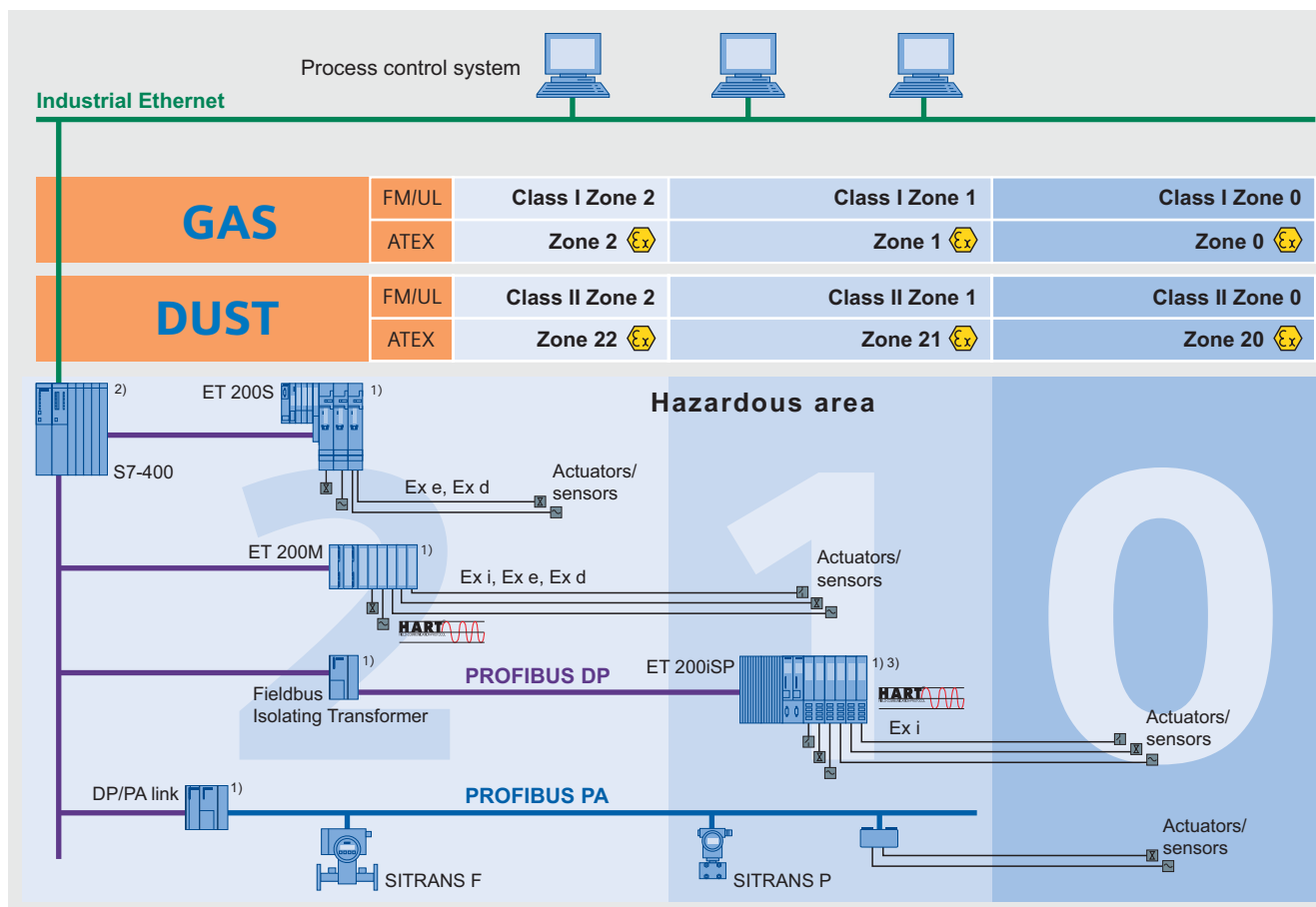

ET 200 in explosive gas and dust atmospheres

1) Dust atmospheres: installation of components always in an enclosure with IP6x degree of protection.

2) With 10 A DC standard power supply

3) Also complies with FM/UL according to Class I Division 2

The diagram shows the various interfacing possibilities for the distributed I/Os of SIMATIC PCS 7 with consideration of various ambient conditions.

Ex I/O modules from the ET 200M range

The ET 200M can be run in Ex zone 2/22. The actuators/sensors can be positioned in Ex zone 1/21 when suitable Ex input/output modules are used. Hot swapping of I/O modules within Ex zone 2 is allowed with the right permit (e.g. fire certificate). FM approvals: Class I, Division 2 and Class I, Zone 2.

Field devices with PROFIBUS PA capability

Using PROFIBUS it is possible to integrate field/process devices directly in Ex zones 1, 2, 21 or 22, and sensors/actuators can also be integrated in zone 0 or 20. FM approvals: Class I, Division 1 and Class I, Zone 0.

Integration of actuators/sensors using ET 200iSP

The ET 200iSP appropriate for gaseous and dusty atmospheres can be installed, according to CENELEC II 2 G (1) GD Eex d e [ib/ia] IIC T4 directly in the Ex zones 1, 2, 21 or 22 as well as in non-hazardous areas. The intrinsically-safe sensors, actuators and HART field devices can also be located in zone 0 or 20 if necessary.

Intrinsically-safe operator control unit

An intrinsically safe PC operator control unit can be used in hazardous areas, zone 1, 2, 21 or 22, if required. For further details on this operator control unit, see Catalog "Add Ons for the SIMATIC PCS 7 Process Control System".

Function**Possible online modifications among the process I/Os**

ET 200M	<ul style="list-style-type: none"> • Adding of ET 200M stations • Adding of I/O modules for the station • Reparameterization of I/O modules • Parameterization of connected HART field devices with SIMATIC PDM
ET 200iSP	<ul style="list-style-type: none"> • Adding of ET 200iSP stations • Adding of modules for the station • Reparameterization of modules
ET 200S	<ul style="list-style-type: none"> • Adding of ET 200S stations
PROFIBUS DP, PROFIBUS PA	<ul style="list-style-type: none"> • Adding of PROFIBUS DP stations • Adding of DP/PA links and field devices • Parameterization of field devices with SIMATIC PDM

Process I/O

Central I/O

Central I/O modules

Overview



Signal modules from the SIMATIC S7-400 range can be used in the SIMATIC PCS 7 automation system if necessary. These are primarily an alternative to use of distributed I/Os in the case of small applications or systems with a small distributed configuration.

For SIMATIC PCS 7, the I/O modules listed in the Ordering data have been selected from the range of S7-400 signal modules.

Notes:

Apart from these selected modules it is also possible to use - with limitations in functions - all other I/O modules from the current range of S7-400 signal modules.

All process data from the I/O are available for PCS 7 engineering in the CFC, and can be graphically interconnected to the signal name in the signal list. Diagnostics information is generated automatically when using the I/O modules listed here.

When using other I/O modules, integration in SIMATIC PCS 7 is limited to the process data, i.e. the full scope of diagnostics functions is not automatically available. These modules can therefore only be used meaningfully in SIMATIC PCS 7 if the diagnostics capability can be omitted.

Online modifications and redundancy are not supported by the central I/O.

Technical specifications

You can find the detailed technical data of the S7-400 modules at the following points:

- Catalog ST 70 or
- on the Mall/CA 01 under "Industrial automation systems / Controllers / SIMATIC S7"

Selection and Ordering Data

Order No.

SM 421 Digital Input Modules

- 32 inputs, 24 V DC
- 32 inputs, 120 V AC/DC
- 16 inputs, 24 V DC, with process/diagnostics interrupt
- 16 inputs, 24 to 60 V AC/DC, with process/diagnostics interrupt
- 16 inputs, 120/230 V AC/DC, inputs according to IEC 1131-2 Type 2

6ES7 421-1BL01-0AA0

6ES7 421-1EL00-0AA0

6ES7 421-7BH01-0AB0

6ES7 421-7DH00-0AB0

6ES7 421-1FH20-0AA0

SM 422 Digital Output Modules

- 32 outputs; 24 V DC, 0.5 A
- 32 outputs, 24 V DC, 0.5 A; with diagnostics
- 16 outputs, 24 V DC; 2 A
- 16 outputs; relay contacts
- 16 outputs, 120/230 V AC; 2 A

6ES7 422-1BL00-0AA0

6ES7 422-7BL00-0AB0

6ES7 422-1BH11-0AA0

6ES7 422-1HH00-0AA0

6ES7 422-1FH00-0AA0

SM 431 Analog Input Modules

- 16 inputs, non-floating, 13 bit
- 8 inputs, floating, 13 bit
- 8 inputs, floating, 14 bit, with linearization (RTD/TC)
- 8 inputs, floating, 14 bit
- 16 inputs, floating, 16 bit; process interrupt capability, with diagnostics interrupt
- 8 inputs, floating, 16 bit; process interrupt capability, for thermocouples, with diagnostics interrupt
- 8 inputs, floating, 16 bit; process interrupt capability, for thermal resistors, with diagnostics interrupt

6ES7 431-0HH00-0AB0

6ES7 431-1KF00-0AB0

6ES7 431-1KF10-0AB0

6ES7 431-1KF20-0AB0

6ES7 431-7QH00-0AB0

6ES7 431-7KF00-0AB0

6ES7 431-7KF10-0AB0

SM 432 Analog Output Modules

- 8 outputs, floating, 13 bit; for ± 10 V, 0 to 10 V, 1 to 5 V, ± 20 mA, 0 to 20 mA, 4 to 20 mA

6ES7 432-1HF00-0AB0

Front Connector (1 unit)

- With screw contacts
- With spring clamps
- With crimp contacts

6ES7 492-1AL00-0AA0

6ES7 492-1BL00-0AA0

6ES7 492-1CL00-0AA0 B)

B) Subject to export regulations: AL: N, ECCN: EAR99H

Overview

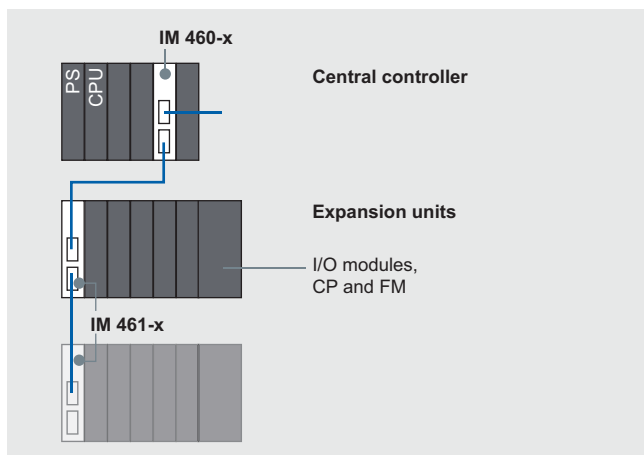

Expansion units can be used for the distributed expansion of the SIMATIC S7-400. The IM 460-x interface modules are used as the interface for these expansion units.

Restrictions compared to standard I/O modules from the ET 200M range

- No redundant interfacing of expansion units
- No configuration during normal operation

Subracks

The universal racks (UR) are used for SIMATIC PCS 7. They can be used as central racks and as expansion racks. Other racks: see Catalog ST 70.

Selection and Ordering Data

Order No.

IM 460-0 interface module <ul style="list-style-type: none"> • Transmitter module for central controller • Without transmission of voltage to the expansion unit • Cable up to 5 m long • With K-bus for communication with CPs and FMs in the expansion unit • For connecting as many as 8 expansion units 	6ES7 460-0AA01-0AB0
IM 461-0 interface module Corresponding receiver module for the expansion unit	6ES7 461-0AA01-0AA0
IM 460-1 interface module <ul style="list-style-type: none"> • Transmitter module for central controller • With transmission of the 5 V supply for I/O modules • Cable up to 1.5 m long • Without transmission of the K-bus, hence solely for communication from I/O modules 	6ES7 460-1BA01-0AB0
IM 461-1 interface module Corresponding receiver module for the expansion unit	6ES7 461-1BA01-0AA0

Selection and Ordering Data

Order No.

IM 460-3 interface module <ul style="list-style-type: none"> • Transmitter module for central controller • Without transmission of voltage to the expansion unit • Cable up to 100 m long • With K-bus for communication with CPs and FMs in the expansion unit • For connecting as many as 8 expansion units 	6ES7 460-3AA01-0AB0
IM 461-3 interface module Corresponding receiver module for the expansion unit	6ES7 461-3AA01-0AA0
UR1 rack for central controllers and expansion units <ul style="list-style-type: none"> • 18 slots • Suitable for redundant power supply 	6ES7 400-1TA01-0AA0
UR2 rack for central controllers and expansion units <ul style="list-style-type: none"> • 9 slots • Suitable for redundant power supply 	6ES7 400-1JA01-0AA0

Accessories**468-1 connecting cable**

for connecting IM 460-0 and IM 461-0; IM 460-3 and IM 461-3

- 0.75 m
- 1.5 m
- 5 m

6ES7 468-1AH50-0AA0
6ES7 468-1BB50-0AA0
6ES7 468-1BF00-0AA0

Additional lengths for connecting IM 460-3 and IM 461-3

- 10 m
- 25 m
- 50 m
- 100 m

6ES7 468-1CB00-0AA0
6ES7 468-1CC50-0AA0
6ES7 468-1CF00-0AA0
6ES7 468-1DB00-0AA0

Terminator
for IM 461-0

6ES7 461-0AA00-7AA0

468-3 connecting cable

for connecting IM 460-1 and IM 461-1

- 0.75 m
- 1.5 m

6ES7 468-3AH50-0AA0
6ES7 468-3BB50-0AA0

SIMATIC PCS 7 MTA terminal module

Overview

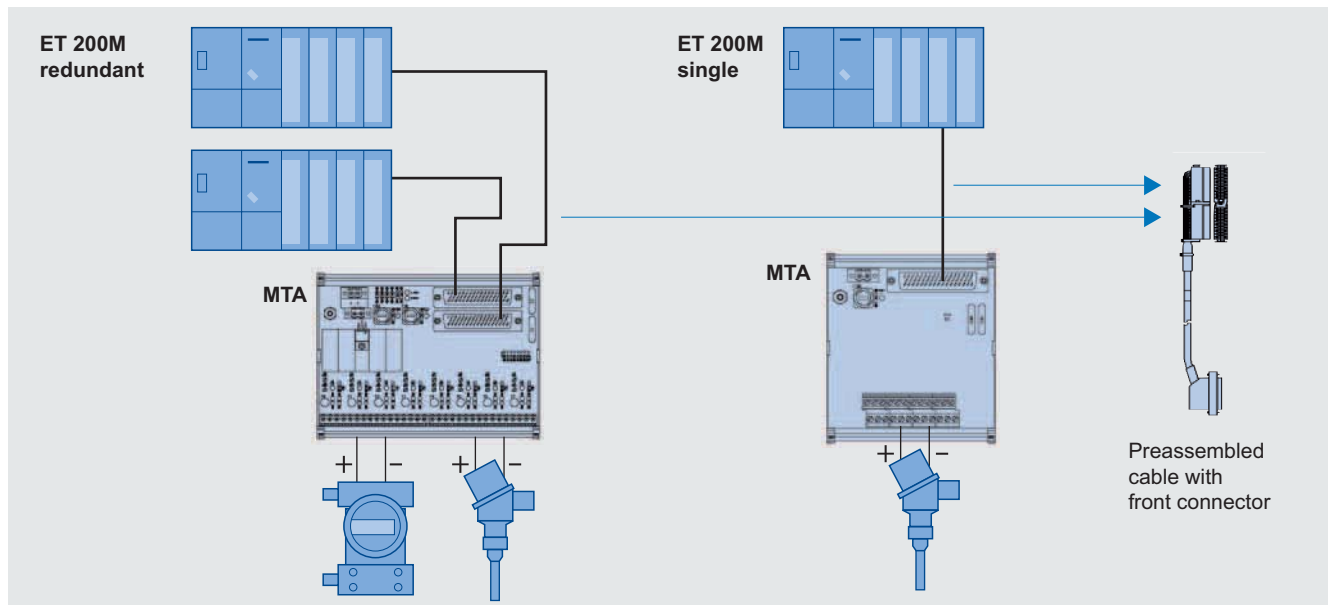

The terminal modules SIMATIC PCS 7 MTA (Marshaled Termination Assemblies) enable simple, fast and reliable connection of field devices, sensors and actuators to the I/O modules of the ET 200M remote I/O stations. They can be used to significantly reduce the costs and required work for cabling and commissioning, and prevent wiring errors.

The individual SIMATIC PCS 7 MTAs are each tailored to specific I/O modules from the ET 200M range (see design for assignment table). MTA versions are available for standard I/O modules as well as for redundant and safety-related I/O modules.

The SIMATIC PCS 7 MTAs are connected to the I/O modules using 3 m or 8 m long preassembled cables.

Design

- SIMATIC PCS 7 MTA in versions for standard, redundant and safety-related I/O modules of the ET 200M distributed I/O system
- Redundant 24 V DC supply
- 3 or 8 m long preassembled cables for connecting SIMATIC PCS 7 MTA and ET 200M module, in each case with:
 - 50/25-pole Sub-D socket or 25-pole Sub-D connector, for connection to SIMATIC PCS 7 MTA
 - 40/20-pole Siemens front connector, female version, for connection to ET 200M module
- Screw terminals for the 1:1 connection of field devices, sensors and actuators
- Fuse assembly with LED for each input/output channel
- Test and release as SIMATIC PCS 7 system component with corresponding approvals (FM, UL, CE, ATEX, TÜV)

SIMATIC PCS 7 MTA terminal module

Product overview with information on combinable ET 200M modules and connection cables

MTA type	Input/output area.	Order No. of MTA	Order No. of ET 200M module	Order No. of connecting cable	I/O redundancy
8 channels, AI	1 - 5 V 0/4 - 20 mA	6ES7 650-1AA51-2XX0	6ES7 331-7NF00-0AB0 (from product version 5)	6ES7 922-3BD00-0AS0 (3 m) 6ES7 922-3BJ00-0AS0 (8 m)	yes
8 channels, AO	4 to 20 mA	6ES7 650-1AB51-2XX0	6ES7 332-5HF00-0AB0 (from product version 3)	6ES7 922-3BD00-0AS0 (3 m) 6ES7 922-3BJ00-0AS0 (8 m)	yes
8 channels, AI TC	Thermocouple types B, C, N, E, R, S, J, L, T, K, U	6ES7 650-1AF51-2XX0	6ES7 331-7PF10-0AB0 (from product version 4) and 6ES7 331-7PF11-0AB0	6ES7 922-3BD00-0AS0 (3 m) 6ES7 922-3BJ00-0AS0 (8 m)	no
8 channels, AI RTD	Resistance thermometers Pt100, Pt200, Pt500, Pt1000, Ni100, Ni120, Ni200, Ni500, Ni1000, Cu10	6ES7 650-1AG51-2XX0	6ES7 331-7PF00-0AB0 (from product version 8) and 6ES7 331-7PF01-0AB0	6ES7 922-3BD00-0AS0 (3 m) 6ES7 922-3BJ00-0AS0 (8 m)	no
16 channels, DO	24 V DC, 0.5 A	6ES7 650-1AD10-2XX0	6ES7 322-8BH01-0AB0	6ES7 922-3BD00-0AT0 (3 m) 6ES7 922-3BJ00-0AT0 (8 m)	yes
6 channels F-AI (safety-related)	4 to 20 mA	6ES7 650-1AH51-5XX0	6ES7 336-1HE00-0AB0 (from product version 6)	6ES7 922-3BD00-0AS0 (3 m) 6ES7 922-3BJ00-0AS0 (8 m)	yes
16 channels, DI	24 V DC	6ES7 650-1AC11-3XX0	6ES7 321-7BH01-0AB0 (from product version 2)	6ES7 922-3BD00-0AM0 (3 m) 6ES7 922-3BJ00-0AM0 (8 m)	yes
24 channels F-DI (safety-related)	24 V DC	6ES7 650-1AK11-7XX0	6ES7 326-1BK00-0AB0 and 6ES7 326-1BK01-0AB0 (from product version 1)	6ES7 922-3BD00-0AS0 (3 m) 6ES7 922-3BJ00-0AS0 (8 m)	yes
10 channels F-DO (safety-related)	24 V DC, 2 A	6ES7 650-1AL11-6XX0	6ES7 326-2BF01-0AB0 (from product version 2)	6ES7 922-3BD00-0AN0 (3 m) 6ES7 922-3BJ00-0AN0 (8 m)	yes
10 channels F-DO relay (safety- related)	110 - 220 V AC, 5 A; 24 V DC, 5 A	6ES7 650-1AM31-6XX0	6ES7 326-2BF01-0AB0 (from product version 2)	6ES7 922-3BD00-0AS0 (3 m) 6ES7 922-3BJ00-0AS0 (8 m)	yes

Selection and Ordering Data

Order No.

SIMATIC PCS 7 MTA

**SIMATIC PCS 7 MTA AI,
8-channel**

Terminal module for connection of field devices/sensors to a single or two redundant ET 200M analog input modules

6ES7 331-7NF00-0AB0

Input range: 1 ... 5 V and
0/4 ... 20 mA**6ES7 650-1AA51-2XX0****SIMATIC PCS 7 MTA AO,
8-channel**

Terminal module for connection of field devices/actuators to a single or two redundant ET 200M analog output modules

6ES7 332-5HF00-0AB0

Output range: 4 ... 20 mA

6ES7 650-1AB51-2XX0**SIMATIC PCS 7 MTA AI TC,
8-channel**

Terminal module for connection of field devices/sensors to a single ET 200M analog input module

6ES7 331-7PF10-0AB0 or
6ES7 331-7PF11-0AB0Input range: Thermocouple types
B, C, N, E, R, S, J, L, T, K, U**6ES7 650-1AF51-2XX0** B)

Selection and Ordering Data

Order No.

**SIMATIC PCS 7 MTA AI RTD,
8-channel**

Terminal module for connection of field devices/sensors to a single ET 200M analog input module

6ES7 331-7PF00-0AB0 or
6ES7 331-7PF01-0AB0Measuring range: Resistance
thermometers Pt100, Pt200,
Pt500, Pt1000, Ni100, Ni120,
Ni200, Ni500, Ni1000, Cu10**6ES7 650-1AG51-2XX0****SIMATIC PCS 7 MTA DO,
16-channel**

Terminal module for connection of field devices/sensors to a single or two redundant ET 200M digital output modules

6ES7 322-8BH01-0AB0

Output range: 24 V DC, 0.5 A

6ES7650-1AD10-2XX0 B)

B) Subject to export regulations: AL: N, ECCN: EAR99H

SIMATIC PCS 7 MTA terminal module

Selection and Ordering Data

Order No.

SIMATIC PCS 7 MTA F-AI, 6-channel

Terminal module for connection of field devices/sensors to a single or two redundant safety-related ET 200M analog input modules 6ES7 336-1HE00-0AB0

Input range: 4 to 20 mA

Accessories included:

- One 5.6 V Zener diode board for MTA F-AI, 6-channel, 6ES7 650-1BB51-0XX0
- One 6.2 V Zener diode board for MTA F-AI, 6-channel, 6ES7 650-1BC51-0XX0
- Two FET switch adapters for MTA F-AI, 6-channel, 6ES7 650-1BD51-0XX0

6ES7 650-1AH51-5XX0 B)

SIMATIC PCS 7 MTA DI, 16-channel

Terminal module for connection of field devices/sensors to a single or two redundant ET 200M digital input modules 6ES7 321-7BH01-0AB0

Input range: 24 V DC

6ES7 650-1AC11-3XX0

SIMATIC PCS 7 MTA F-DI, 24-channel

Terminal module for connection of field devices/sensors to a single or two redundant safety-related ET 200M digital input modules 6ES7 326-1BK00-0AB0 or 6ES7 326-1BK01-0AB0

Input range: 24 V DC

6ES7 650-1AK11-7XX0

SIMATIC PCS 7 MTA F-DO, 10-channel

Terminal module for connection of field devices/actuators to a single or two redundant safety-related ET 200M digital output modules 6ES7 326-2BF01-0AB0

Output range: 24 V DC, 2 A

6ES7 650-1AL11-6XX0

SIMATIC PCS 7 MTA F-DO relay, 10-channel

Terminal module for connection of field devices/actuators to a single or two redundant safety-related ET 200M digital output modules 6ES7 326-2BF01-0AB0

Output range: 110 ... 220 V AC, 5 A; 24 V DC, 5 A

Notice:

Available with 12/2007

6ES7 650-1AM31-6XX0 B)

Selection and Ordering Data

Order No.

Preassembled cable for connection of ET 200 module and SIMATIC PCS 7 MTA**Connecting cable with 40-pole front connector for ET 200M and 50-pole Sub-D connector (female) for MTA**

Lengths:

- 3 m
- 8 m

6ES7 922-3BD00-0AS0

6ES7 922-3BJ00-0AS0

Connecting cable with 40-pole front connector for ET 200M and 25-pole Sub-D connector for MTA

Lengths:

- 3 m
- 8 m

6ES7 922-3BD00-0AT0

6ES7 922-3BJ00-0AT0

Connecting cable with 40-pole front connector for ET 200M and 25-pole Sub-D connector (female) for MTA

Lengths:

- 3 m
- 8 m

6ES7 922-3BD00-0AN0

6ES7 922-3BJ00-0AN0

Connecting cable with 20-pole front connector for ET 200M and 25-pole Sub-D connector (female) for MTA

Lengths:

- 3 m
- 8 m

6ES7 922-3BD00-0AM0

6ES7 922-3BJ00-0AM0

Accessories

Power monitor board (PMB) for display of status of redundant MTA power supply

6ES7 650-1BA01-0XX0

Boards and adapter for SIMATIC PCS 7 MTA F-AI, 6-channel

- 5.6 V Zener diode board
- 6.2 V Zener diode board
- FET switch adapter

6ES7 650-1BB51-0XX0 B)

6ES7 650-1BC51-0XX0 B)

6ES7 650-1BD51-0XX0 B)

B) Subject to export regulations: AL: N, ECCN: EAR99H

Overview



Within the ET 200 range, ET 200M represents the main series of distributed I/O systems for process control applications with SIMATIC PCS 7.

The ET 200M has a versatile range of I/O modules of S7-300 design, including ones with special I&C functions.

- Standard analog and digital modules
- Redundant I/O modules (DI 16 x DC 24 V, with diagnostics capability; DO 32 x DC 24 V/0.5 A; AI 8 x 12 bit)
- I/O modules with enhanced diagnostics capability
- Ex I/O modules
- Controller and counter modules
- HART modules
- F-modules for safety-related applications

When using active bus modules, faulty I/O modules can be replaced while the plant is in operation (RUN) without influencing adjacent modules (hot swapping function).

The following actions are possible with the automation system in RUN:

- Addition of new modules within a station
- Reparameterization of modules
- Addition of ET 200M stations

The connected HART field devices can be parameterized using SIMATIC PDM.

Note:

Apart from these selected modules it is also possible to use - with limitations in functions - all other I/O modules from the current range of S7-300 signal modules.

Design

An ET 200M remote I/O station comprises:

- 1 or 2 (redundant) power supply modules (can be omitted in the case of a central 24 V DC supply for the plant)
- 1 or 2 (redundant) IM 153 interface modules for connection via PROFIBUS DP with transmission rates of up to 12 Mbit/s
- Up to 12 I/O modules for connection of sensors/actuators

All I/O modules have optical electrical isolation from the back-plane bus. Up to 12 I/O modules can be connected to an IM 153-2 High Feature interface module, or up to 8 to an IM 153-2 FO High Feature interface module. The interface modules can also have a redundant design if required.

In addition to the standard SIMATIC S7 I/O modules, special I/O modules with diagnostics capability offer the following functions, among others:

- Channel-based diagnostics, e.g. open-circuit, short-circuit, limit violations
- Internal module monitoring, e.g. parameterization error, RAM error, tripped fuse
- Flatter monitoring for sensors
- Pulse stretching
- Output of a selectable substitute value on failure of the central processing unit

In the event of a fault, the modules with diagnostics capability automatically pass on the corresponding message to the operator station, permitting fast and simple troubleshooting.

The ET 200M can be used in standard environments and also in Ex zones 2 and 22. The actuators/sensors can be positioned in Ex zones 1 and 21 when suitable Ex input/output modules are used. Hot swapping of I/O modules within Ex zone 2 and 22 is allowed with the right permit (e.g. fire certificate).

Technical specifications

You can find detailed technical data on the ET 200M and S7-300 I/O modules

- in Catalog ST 70 or
- in the Mall / Catalog CA 01 under "Industrial automation systems / Controllers / SIMATIC S7"

Options

SIPLUS extreme range for extended temperature ranges and corrosive environments

The "standard" properties of an individual device or system are often insufficient for harsh environmental conditions, applications in corrosive environments or extreme temperature ranges. Depending on the location of use, the result could be limitations in functionality or operational safety or even total failure of the plant.

The SIPLUS extreme range offers individually adapted standard products which permit retention of the functionality of your plant or process even under extreme conditions of use. These include:

- Ambient temperature range from -25 to +60/+70 °C
- Condensation, high humidity
- Increased mechanical stress
- Extreme loading by media, e.g. toxic atmospheres
- Voltage ranges deviating from the standard
- Increased degree of protection (dust, water)

You can find a summary of the available range of products classified according to their special properties on the Internet. The corresponding SIPLUS product is assigned there to the standard product. Note: SIPLUS products are also included in the Catalog ST 70.

Additional information is available in the Internet under:



<http://www.siemens.com/siplus>

Process I/O

ET 200M distributed I/O

Power supply

Overview

You can use the PS 307 or PS 305 load power supplies as the power supply module for the ET 200M. You can select different input voltages and output currents (120/230 V AC with 2 A, 5 A or 10 A or 24 to 110 V DC with 2 A) depending on the application.

With a redundant ET 200M configuration, it is also recommendable to have a redundant 24 V DC supply, e.g. with two PS 307 / PS 305 load power supplies.

Selection and Ordering Data

Order No.

PS 307 Load Power Supply

Including connection assembly;

- 120/230 V AC; 24 V DC
 - 2 A; 50 mm wide
 - 5 A; 80 mm wide
 - 5 A, extended temperature range; 80 mm wide
 - 10 A, 200 mm wide

6ES7 307-1BA00-0AA0**6ES7 307-1EA00-0AA0****6ES7 307-1EA80-0AA0****6ES7 307-1KA01-0AA0**

PS 305 Load Power Supply

Including connection assembly;

- 24/48/60/110 V DC; 24 V DC
 - 2 A, extended temperature range; 80 mm wide

6ES7 305-1BA80-0AA0

Overview



The IM 153-2 High Feature interface module (electrical PROFIBUS DP transmission) or IM 153-2 FO High Feature interface module (optical PROFIBUS DP transmission) is required to connect the ET 200M remote I/O station to the PROFIBUS DP fieldbus. Depending on the fieldbus configuration (single/redundant), the ET 200M remote I/O station can be connected via one single or two redundant interface modules.

The IM 153-2 High Feature supports the following functions:

- HART configuring of intelligent field devices
- Configuration of ET 200M I/Os in RUN mode of the automation system
- Connection to redundant AS 412H / AS 414H / AS 417H automation systems
- Use of ET 200M function modules (controller and counter modules)
- Operation of up to 12 I/O modules per remote I/O station
- Time stamping (SOE) with the safety-related SM 326F digital input module (F-DI24)
- Transmission of additional values with HART secondary variables of the HART SM 331 and SM 332 analog modules (up to 4 per channel or up to 8 per module)

On the other hand, the fiber-optic (FO) version IM 153-2 FO High Feature provides the following functions:

- HART configuring of intelligent field devices
- Configuration of ET 200M I/Os in RUN mode of the automation system
- Connection to redundant AS 412H, AS 414H and AS 417H automation systems
- Use of ET 200M function modules (controller and counter modules)
- Operation of up to 8 I/O modules per remote I/O station

Notes:

In order to use the hot swapping function, it is necessary to use the active bus modules and the DIN rail for hot swapping (refer to page 11/12). When using the IM 153-2 FO, additional plastic FOCs and an assembly set for Simplex connectors are required (refer to page 9/40).

Selection and Ordering Data

Order No.

IM 153-2 High Feature

Slave interface module for connection of an ET 200M to PROFIBUS DP, with time stamp (accuracy 1 ms), support of HART functionality, F modules, FM modules, "Configuration in RUN" function; also for use in redundant systems

6ES7 153-2BA02-0XB0

B)

IM 153-2 FO High Feature

Slave interface module for connection of an ET 200M to optical PROFIBUS DP; support of HART functionality, F modules, FM modules, "Configuration in RUN" function; also for use in redundant systems

6ES7 153-2BB00-0XB0

B)

B) Subject to export regulations: AL: N, ECCN: EAR99H

Process I/O

ET 200M distributed I/O

ET 200M accessories

Overview

Following components are available as accessories for the ET 200M:

- Bus modules for hot swapping
- DIN rail for hot swapping
- Covers for backplane bus and bus modules
- Front connectors
- Ex partition for ET 200M
- LK 393 cable duct
- DM 370 dummy module

Ex partition

A mechanical isolation is required between the IM 153 interface module and the first Ex I/O module. For the hot swapping function, an Ex partition is installed which guarantees the prescribed isolation distance between non-intrinsically-safe and intrinsically-safe areas of an ET 200M remote I/O station.

LK 393 cable duct

The LK 393 cable duct provides the prescribed isolation between the load voltage input and the intrinsically safe inputs/outputs. The cable duct is easy to fit following insertion of the load voltage inputs L+.

DM 370 dummy module

- Reservation of slots for unconfigured I/O modules
- Retention of design and address assignment when replacing by I/O module

Design

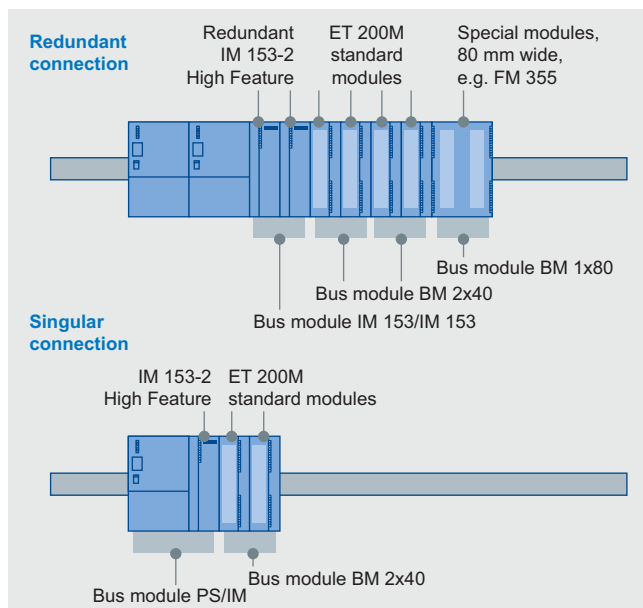

The figure shows use of the various bus modules for hot swapping - at the top for a redundant connection, at the bottom for a non-redundant connection.

Selection and Ordering Data

Order No.

Bus modules for hot swapping

- | | |
|---|----------------------------|
| • BM PS/IM for load power supply and IM 153, incl. 1 bus module cover | 6ES7 195-7HA00-0XA0 |
| • BM 2x40 for 2 modules, each 40 mm wide | 6ES7 195-7HB00-0XA0 |
| • BM 1x80 for 1 module, 80 mm wide | 6ES7 195-7HC00-0XA0 |
| • BM IM/IM for two IM 153-2/-2 FOs for design of redundant systems | 6ES7 195-7HD10-0XA0 |

Profile rail for hot swapping

- | | |
|---|----------------------------|
| • 482 mm long (19 inches) | 6ES7 195-1GA00-0XA0 |
| • 530 mm long | 6ES7 195-1GF30-0XA0 |
| • 630 mm long | 6ES7 195-1GG30-0XA0 |
| • 2000 mm long, for vertical installation | 6ES7 195-1GC00-0XA0 |

Covers

- | | |
|---|----------------------------|
| Pack with 4 backplane bus covers and 1 bus module cover | 6ES7 195-1JA00-0XA0 |
|---|----------------------------|

Front connector (1 unit)

- | | |
|--------------------------------|-------------------------------|
| • 20-pin, with screw contacts | 6ES7 392-1AJ00-0AA0 |
| • 20-pin, with spring contacts | 6ES7 392-1BJ00-0AA0 |
| • 40-pin, with screw contacts | 6ES7 392-1AM00-0AA0 |
| • 40-pin, with spring contacts | 6ES7 392-1BM01-0AA0 |
| • 20-pin, FastConnect | 6ES7 392-1CJ00-0AA0 B) |
| • 40-pin, FastConnect | 6ES7 392-1CM00-0AA0 B) |

Front connector for Ex analog input module 6ES7 331-7SF00-0AB0 (1 unit)

- 20-pin, with screw contacts
- Enables an accuracy of ± 1.5 °K for the internal cold junction temperature when taking thermocouple temperature measurements in the measuring mode "internal compensation" at ambient temperatures of 0 ... 60 °C

Ex partition for ET 200M

- | | |
|---|----------------------------|
| • Separation of IM 153 and downstream Ex modules within an ET 200M line | 6ES7 195-1KA00-0XA0 |
| • Mixed operation of non-Ex and Ex modules within an ET 200M line | |
| • For supporting the hot swapping function in connection with IM 153-2 | |

LK 393 cable duct

- | | |
|--|----------------------------|
| [EEEx ib] IIC-conform routing of load voltage cable in front plug, 5 units | 6ES7 393-4AA00-0AA0 |
|--|----------------------------|

DM 370 dummy module

- | | |
|--|----------------------------|
| including bus connector, labeling strips | 6ES7 370-0AA01-0AA0 |
|--|----------------------------|

B) Subject to export regulations: AL: N, ECCN: EAR99H

Process I/O

ET 200M distributed I/O

Bundles

Overview

The following preassembled bundles are available for the ET 200M:

- I/O subsystem for ET 200M stations with up to 8 I/O modules suitable for hot swapping, comprising:
 - DIN rail for active bus modules, 482 mm long (19 inches)
 - PS/IM bus module
 - PROFIBUS DP IM 153-2 High Feature interface module
- I/O subsystem Extended for ET 200M stations with up to 12 I/O modules suitable for hot swapping, comprising:
 - DIN rail for active bus modules, 630 mm long
 - PS/IM bus module
 - PROFIBUS DP IM 153-2 High Feature interface module
- IM 153 redundancy bundle for operation of the ET 200M on the AS 412H / AS 414H / AS 417H fault-tolerant automation system, comprising:
 - 2 PROFIBUS DP IM 153-2 High Feature interface modules
 - 1 IM/IM active bus module

Selection and Ordering Data

Order No.

I/O subsystem for ET 200M for ET 200M stations with up to 8 I/O modules, suitable for hot swapping, comprising: <ul style="list-style-type: none"> • DIN rail for active bus modules, 482 mm long (19 inches) • PS/IM bus module • PROFIBUS DP IM 153-2 High Feature interface module 	6ES7 654-0XX08-1XA0 B)
I/O subsystem extended for ET 200M for ET 200M stations with up to 12 I/O modules, suitable for hot swapping, comprising: <ul style="list-style-type: none"> • DIN rail for active bus modules, 630 mm long • PS/IM bus module • PROFIBUS DP IM 153-2 High Feature interface module 	6ES7 654-0XX08-1XB0 B)
IM 153 redundancy bundle for operation of a ET 200M station on the AS 412H, AS 414H or AS 417H fault-tolerant automation system, comprising: <ul style="list-style-type: none"> • 2 PROFIBUS DP IM 153-2 High Feature interface modules • 1 IM/IM active bus module 	6ES7 153-2AR03-0XA0 B)

B) Subject to export regulations: AL: N, ECCN: EAR99H

Process I/O

ET 200M distributed I/O

DI - digital input modules

Overview



The digital input modules described here break down into

- simple signal modules for direct and alternating voltage, and
- modules with diagnostics capability that automatically output a corresponding message to the operator system in the event of a fault.

Selection and Ordering Data Order No.

SM 321 for floating contacts (supply with DC voltage)

16 inputs, 24 V DC Redundant design possible (module redundancy) <ul style="list-style-type: none"> • Electrically isolated in groups of 16 • Front connector required: 20-contact 	6ES7 321-1BH02-0AA0
16 inputs, 24 V DC <ul style="list-style-type: none"> • Electrically isolated in groups of 16; active low • Front connector required: 20-contact 	6ES7 321-1BH50-0AA0
16 inputs, 24 V DC, high-speed <ul style="list-style-type: none"> • Electrically isolated in groups of 16 • 0.05 ms input delay • Front connector required: 20-contact 	6ES7 321-1BH10-0AA0
32 inputs, 24 V DC Redundant design possible (module redundancy) <ul style="list-style-type: none"> • Electrically isolated in groups of 16 • Front connector required: 40-contact 	6ES7 321-1BL00-0AA0
16 inputs, 48 to 125 V DC <ul style="list-style-type: none"> • Electrically isolated in groups of 8 • Front connector required: 20-contact 	6ES7 321-1CH20-0AA0 B)

SM 321 for floating contacts (supply with DC/AC voltage)

16 inputs, 24 to 48 V AC/DC <ul style="list-style-type: none"> • Electrically isolated in groups of 1 • Front connector required: 40-contact 	6ES7 321-1CH00-0AA0 B)
---	-------------------------------

SM 321 for floating contacts (supply with AC voltage)

32 inputs, 120 V AC <ul style="list-style-type: none"> • Electrically isolated in groups of 8 • Front connector required: 40-contact 	6ES7 321-1EL00-0AA0 B)
8 inputs, 120/230 V AC Redundant design possible (module redundancy) <ul style="list-style-type: none"> • Electrically isolated in groups of 2 • Front connector required: 20-contact 	6ES7 321-1FF01-0AA0 B)
16 inputs, 120/230 V AC <ul style="list-style-type: none"> • Electrically isolated in groups of 4 • Front connector required: 20-contact 	6ES7 321-1FH00-0AA0 B)

B) Subject to export regulations: AL: N, ECCN: EAR99H

Selection and Ordering Data	Order No.	Selection and Ordering Data	Order No.
<p>SM 321 for non-floating contacts (supply with AC voltage)</p> <p>8 inputs, 120/230 V AC</p> <ul style="list-style-type: none"> Electrically isolated in groups of 1 Front connector required: 40-contact 	6ES7 321-1FF10-0AA0 B)	<p>16 inputs, NAMUR</p> <p>Redundant design possible (module redundancy)</p> <ul style="list-style-type: none"> Electrically isolated in groups of 8 Time stamping in association with IM 153-2 High Feature, accuracy 5 ms, rising or falling edge, can be parameterized channel-granular Two sensor supplies (8.2 V DC or 18 V DC each) Connection of NAMUR sensors or contacts with resistor circuit Pulse stretching Channel-granular diagnostics (short-circuit, open-circuit, chatter monitoring, discrepancy with changeover contacts) Diagnostics inside module Front connector required: 40-contact 	6ES7 321-7TH00-0AB0
<p>SM 321 modules with diagnostics capability (IM 153-2 High Feature interface module required) for floating contacts (supply with DC voltage)</p> <p>16 inputs, 24 V DC</p> <p>Redundant design possible (module and channel redundancy)</p> <ul style="list-style-type: none"> Electrically isolated in groups of 16 Time stamping in association with IM 153-2 High Feature, accuracy 5 ms, rising or falling edge, can be parameterized channel-granular Two short-circuit-proof sensor supplies for 8 channels each Sensor supply by the module, additional external redundant sensor supply possible Diagnostics of missing sensor supply for channel group (8 channels) Diagnostics inside module Wire break monitoring Front connector required: 20-contact 	6ES7 321-7BH01-0AB0	<p>B) Subject to export regulations: AL: N, ECCN: EAR99H</p>	

Process I/O

ET 200M distributed I/O

DO - digital output modules

Overview



The digital output modules described here break down into

- simple signal modules for DC and AC voltage with different output currents per channel, with a selection of relay modules available for higher output currents and voltages,
- modules with diagnostics capability that supply data for troubleshooting and enable parameterizable reactions to a failure of the automation system.

Selection and Ordering Data Order No.

SM 322 for DC voltage (suitable for solenoid valves, contactors, indicator lights etc.)

8 outputs, 24 V DC / 2 A Redundant design possible (module redundancy) <ul style="list-style-type: none"> • Electrically isolated in groups of 4 • Front connector required: 20-contact 	6ES7 322-1BF01-0AA0
16 outputs, 24 V DC / 0.5 A <ul style="list-style-type: none"> • Electrically isolated in groups of 8 • Front connector required: 20-contact 	6ES7 322-1BH01-0AA0
16 outputs, 24 V DC / 0.5 A, high-speed <ul style="list-style-type: none"> • Electrically isolated in groups of 8 • Output delay max. 0.2 ms • Front connector required: 20-contact 	6ES7 322-1BH10-0AA0
32 outputs, 24 V DC / 0.5 A Redundant design possible (module redundancy) <ul style="list-style-type: none"> • Electrically isolated in groups of 8 • Front connector required: 40-contact 	6ES7 322-1BL00-0AA0
8 outputs, 48 to 125 V DC / 1.5 A <ul style="list-style-type: none"> • Electrically isolated in groups of 4 • Front connector required: 20-contact 	6ES7 322-1CF00-0AA0 B)

Selection and Ordering Data Order No.

SM 322 for AC voltage (suitable for AC coils, contactors, motor starters, small motors and indicator lights)

8 outputs, 120/230 V AC / 2 A Redundant design possible (module redundancy) <ul style="list-style-type: none"> • Electrically isolated in groups of 4 • Front connector required: 20-contact 	6ES7 322-1FF01-0AA0 B)
16 outputs, 120/230 V AC / 1 A <ul style="list-style-type: none"> • Electrically isolated in groups of 8 • Front connector required: 20-contact 	6ES7 322-1FH00-0AA0 B)
32 outputs, 120/230 V AC / 1 A <ul style="list-style-type: none"> • Electrically isolated in groups of 8 • Front connector required: 2 x 20-contact 	6ES7 322-1FL00-0AA0 B)

SM 322 for relay output (suitable for AC/DC solenoid valves, contactors, motor starters, small motors and indicator lights)

8 outputs, 24 to 120 V DC, 48 to 230 V AC, max. 2 A <ul style="list-style-type: none"> • Electrically isolated in groups of 2 • Front connector required: 20-contact 	6ES7 322-1HF01-0AA0
8 outputs, 24 to 120 V DC, 48 to 230 V AC, max. 5 A <ul style="list-style-type: none"> • Electrically isolated in groups of 1 • Front connector required: 40-contact 	6ES7 322-1HF10-0AA0
16 outputs, 24 to 120 V DC, 48 to 230 V AC, max. 2 A <ul style="list-style-type: none"> • Electrically isolated in groups of 8 • Front connector required: 20-contact 	6ES7 322-1HH01-0AA0

B) Subject to export regulations: AL: N, ECCN: EAR99H

Selection and Ordering Data	Order No.	Selection and Ordering Data	Order No.
<p><i>SM 322 modules with diagnostics capability (with channel and module diagnostics) for DC voltage (suitable for solenoid valves, DC contactors and indicator lights)</i></p> <p>8 outputs, 24 V DC / 0.5 A Redundant design possible (module redundancy)</p> <ul style="list-style-type: none"> • Electrically isolated in groups of 8 • 2 connections per output (with and without series diode) • Connection of a default value by channel in the event of CPU stop (parameterizable) • Wire break monitoring per channel • Load voltage monitoring per channel • Short-circuit monitoring to M/L+ per channel • Module-internal diagnostics functions • Front connector required: 20-contact 	6ES7 322-8BF00-0AB0	<p><i>for AC voltage (suitable for AC coils, contactors, motor starters, small motors and indicator lights)</i></p> <p>8 outputs, 120/230 V AC / 2 A</p> <ul style="list-style-type: none"> • Electrically isolated in groups of 1 • Connection of a default value by channel in the event of CPU stop (parameterizable) • Module-internal diagnostics functions • Front connector required: 40-contact 	6ES7 322-5FF00-0AB0 B)
<p>16 outputs, 24 V DC / 0.5 A Redundant design possible (module and channel redundancy)</p> <ul style="list-style-type: none"> • Electrically isolated in groups of 4 • Connection of a default value by channel in the event of CPU stop (parameterizable) • Wire break monitoring per channel (with 0 and 1 signals) • Signaling of output overload • Load voltage monitoring or ground monitoring per channel group • Short-circuit monitoring to M/L+ per channel group • Module-internal diagnostics functions • Front connector required: 40-contact 		6ES7 322-8BH01-0AB0	
	6ES7 322-5HF00-0AB0 B)		
B) Subject to export regulations: AL: N, ECCN: EAR99H			

Process I/O

ET 200M distributed I/O

DI/DO - digital input/output modules

Overview



- Standard signal module for DC voltage (24 V DC) with 8 digital inputs and 8 digital outputs
- For connection of switches, 2-wire proximity switches (BERO), solenoid valves, contactors, signal lamps

Selection and Ordering Data Order No.

SM 323 for DC voltage (suitable for switches, BERO proximity switches, solenoid valves, contactors, indicator lights etc.)

- 8 inputs 24 V DC
 - Suitable for connection of 2-wire proximity switches (BERO) as sensors
- 8 outputs, 24 V DC / 0.5 A
- Inputs and outputs electrically isolated in groups of 8
- Front connector required: 20-contact

6ES7323-1BH01-0AA0

Overview



The analog input modules described here break down into

- multi-function modules for current, voltage and temperature measurements, and
- special, highly accurate modules for current and voltage measurements or temperature measurements.

All modules automatically supply channel-specific and module-internal diagnostics data, except module 6ES7 331-1KF01-0AB0. With the latter module, channel failure is identified by the PCS 7 analog driver block.

The individual channels of the analog input modules can be parameterized in groups independently of each other.

Selection and Ordering Data Order No.

SM 331 modules for current, voltage and temperature measurements

8 inputs, individually parameterizable

- Resolution 12 bit + sign
- Current measurement 0/4 to 20 mA (8 channels; 2 wires with external supply or 4 wires)
- Voltage measurement (8 channels)
- Resistance thermometer Pt100, Ni100, Ni1000, LG-Ni1000 (8 channels; 2, 3 or 4 wires)
- Front connector required: 40-contact

6ES7 331-1KF01-0AB0

8 inputs in 4 channel groups Redundant design possible (module redundancy)

- Changeover of measurement type by range module per channel group
- Resolution 14 bit + sign
- Current measurement 0/4 to 20 mA (8 channels; 2 or 4 wires)
- Voltage measurement (8 channels)
- Resistance thermometer Pt100, Ni100 (4 channels, 2 or 4 wires)
- Thermocouples type E, N, J, K, L (8 channels), internal compensation or external compensation with compensating box or 0 °C cold junction
- Wire break monitoring
- Diagnostics inside module
- Front connector required: 20-contact

6ES7 331-7KF02-0AB0

2 inputs in 1 channel group

- Changeover of measurement type by range module
- Resolution 14 bit + sign
- Current measurement 0/4 to 20 mA (2 channels; 2 or 4 wires)
- Voltage measurement (2 channels)
- Resistance thermometer Pt100, Ni100 (1 channel, 2 or 4 wires)
- Thermocouples type E, N, J, K, L (2 channels), internal compensation or external compensation with compensating box or 0 °C cold junction
- Wire break monitoring
- Diagnostics inside module
- Front connector required: 20-contact

6ES7 331-7KB02-0AB0 B)

B) Subject to export regulations: AL: N, ECCN: EAR99H

Process I/O

ET 200M distributed I/O

AI - analog input modules

Selection and Ordering Data Order No.

SM 331 modules for current and voltage measurements

8 inputs in 4 channel groups, high-speed

6ES7 331-7HF01-0AB0

- Resolution 13 bit + sign
- Measurement type and range selection adjustable per channel group
- Current measurement 0/4 to 20 mA (2 or 4 wires)
- Voltage measurement
- Limit monitoring adjustable for 2 channels
- Fast updating of measured value
- Supporting of isochronous mode
- Diagnostics inside module
- Front connector required: 20-contact

8 inputs in 4 channel groups Redundant design possible (module and channel redundancy)

6ES7 331-7NF00-0AB0 B)

- Resolution 15 bit + sign
- Current measurement 0/4 to 20 mA (8 channels; 2 or 4 wires)
- Voltage measurement (8 channels)
- Wire break monitoring
- Diagnostics inside module
- Front connector required: 40-contact

8 inputs in 4 channel groups

6ES7 331-7NF10-0AB0 B)

- Resolution 15 bit + sign
- Fast module cycle (min. 10 ms for 4 channels)
- Current measurement 0/4 to 20 mA (8 channels; 2 wires with external supply or 4 wires)
- Voltage measurement (8 channels)
- Wire break monitoring
- Short-circuit-proof
- Isolation between channel groups
- Diagnostics inside module
- Front connector required: 40-contact

Selection and Ordering Data Order No.

SM 331 modules for temperature measurement

8 inputs in 4 channel groups

6ES7 331-7PF01-0AB0 B)

- Resolution 15 bit
- Resistance thermometer Pt100 ... 1000, Ni100 ... 1000, Cu10 (8 channels; 2, 3 or 4 wires)
- Short-circuit-proof
- Wire break monitoring
- Diagnostics inside module
- Front connector required: 40-contact

8 inputs in 4 channel groups

6ES7 331-7PF11-0AB0

- Resolution 15 bit
- Thermocouples type B, C, N, E, R, S, J, L, T, K, U (8 channels), internal compensation; external compensation with Pt100 through separate inputs possible
- Fast module cycle (10 ms for 4 channels)
- Short-circuit-proof
- Wire break monitoring
- Diagnostics inside module
- Front connector required: 40-contact

B) Subject to export regulations: AL: N, ECCN: EAR99H

Overview



The analog output modules for voltage and current described here break down into

- modules with 12 bit resolution and various numbers of channels, and
- a high-precision module with 15 bit resolution.

The analog output modules can be parameterized in groups independently of each other and automatically supply all channel-specific and module-internal diagnostics data.

Selection and Ordering Data Order No.

SM 332 modules for current and voltage outputs

2 outputs in 2 channel groups

6ES7 332-5HB01-0AB0

- Resolution 12 bit + sign
- Voltage 0/1 to 5/10 V; ± 10 V (2 channels; 2 or 4 wires)
- Current 0/4 to 20 mA; ± 20 mA (2 channels; 2 wires)
- Parameterizable substitute value output in case of CPU stop
- Broken wire monitoring (only for current)
- Short circuit monitoring (only for voltage)
- Diagnostics inside module
- Front connector required: 20-contact

4 outputs in 4 channel groups Redundant design possible (module redundancy)

6ES7 332-5HD01-0AB0

- Resolution 12 bit + sign
- Voltage 0/1 to 5/10 V; ± 10 V (4 channels; 4 wires)
- Current 0/4 to 20 mA; ± 20 mA (4 channels; 2 wires)
- Parameterizable substitute value output in case of CPU stop
- Broken wire monitoring (only for current)
- Short circuit monitoring (only for voltage)
- Diagnostics inside module
- Front connector required: 20-contact

8 outputs in 8 channel groups Redundant design possible (module and channel redundancy)

6ES7 332-5HF00-0AB0

- Resolution 12 bit + sign
- Voltage 0/1 to 5/10 V; ± 10 V (8 channels; 4 wires)
- Current 0/4 to 20 mA; ± 20 mA (8 channels; 2 wires)
- Parameterizable substitute value output in case of CPU stop
- Broken wire monitoring (only for current)
- Short circuit monitoring (only for voltage)
- Diagnostics inside module
- Front connector required: 40-contact

4 outputs in 4 channel groups

6ES7 332-7ND02-0AB0 B)

- Resolution 15 bit + sign
- Voltage 0/1 to 5/10 V; ± 10 V (4 channels; 4 wires)
- Current 0/4 to 20 mA; ± 20 mA (4 channels; 2 wires)
- Parameterizable substitute value output in case of CPU stop
- Isolated by channel
- Diagnostics inside module
- Front connector required: 20-contact

B) Subject to export regulations: AL: N, ECCN: EAR99H

Process I/O

ET 200M distributed I/O

Ex modules [EEi xb]

Overview



The following analog and digital I/O modules are suitable for use in hazardous plants. They separate the non-intrinsically safe electrical circuits of the automation system and the intrinsically safe electrical circuits of the process. Sensors and actuators suitable for placing in zone 1 or 21 and 2 or 22 hazardous areas as well as intrinsically safe equipment compliant with DIN 50020 and [EEi ib] IIC can be operated on these modules.

All Ex modules come with diagnostics capability (channel and module diagnostics).

Ex modules identified by "redundant design possible" (6ES7 321-7RD00-0AB0, 6ES7 322-5SD00-0AB0, 6ES7 331-7RD00-0AB0, 6ES7 332-5RD00-0AB0) can also be configured redundant when used in non-hazardous plants.

Selection and Ordering Data

Ex digital input module

4 NAMUR inputs in 4 channel groups Redundant design possible (module redundancy)

- Voltage supply to sensors 8.2 V
- Individually floating channels
- Wire break and short-circuit monitoring (directly at the contact for contacts with external resistor circuit)
- Diagnostics inside module
- Front connector required: 20-contact

6ES7 321-7RD00-0AB0

Ex digital output module

4 outputs, 24 V DC / 10 mA in 4 channel groups Redundant design possible (module redundancy)

- Individually floating channels
- Wire break monitoring
- Short-circuit monitoring
- Diagnostics inside module
- Front connector required: 20-contact

6ES7 322-5SD00-0AB0

Selection and Ordering Data

Order No.

4 outputs, 15 V DC / 20 mA in 4 channel groups

- Individually floating channels
- Wire break monitoring
- Short-circuit monitoring
- Diagnostics inside module
- Front connector required: 20-contact

6ES7 322-5RD00-0AB0

Ex analog input module

4 inputs, 0/4 to 20 mA in 4 channel groups Redundant design possible (module redundancy)

- Individually floating channels
- Resolution 15 bit + sign
- Connection of 2-wire or 4-wire transmitters possible
- Wire break monitoring
- Measurement range monitoring
- Short-circuit-proof
- Diagnostics inside module
- Front connector required: 20-contact

6ES7 331-7RD00-0AB0

8 inputs in 4 channel groups

- Resolution 15 bit + sign
- Thermocouples type T, U, E, J, L, K, N, R, S, B (8 channels)
Internal compensation; external compensation with Pt100 (2 channels), compensating box or 0/50 °C cold junction
- Resistance thermometer Pt100, Pt200, Ni100 (4 channels; 2-wire or 4-wire, 3-wire Pt100 on request)
- Wire break monitoring
- Diagnostics inside module
- Front connector required: 20-contact

6ES7 331-7SF00-0AB0

Note:

A special front connector for the Ex analog input module 6ES7 331-7SF00-0AB0 enables greater accuracy when taking thermocouple temperature measurements in "internal compensation" mode (see page 11/12).

Ex analog output module

4 outputs, 0/4 to 20 mA in 4 channel groups Redundant design possible (module redundancy)

- Individually floating channels
- Resolution 15 bit
- For 2-wire transmitters
- Wire break monitoring
- Diagnostics inside module
- Front connector required: 20-contact

6ES7 332-5RD00-0AB0

For additional Ex modules, refer to page 11/23.

Overview



The modules with HART (Highway Addressable Remote Transducer) which can be used in ET 200M remote I/O stations (with IM 153-2 High Feature interface module) permit connection of HART devices to SIMATIC PCS 7 automation systems.

All transmitters or HART actuators certified for digital communication using the HART protocol can be connected via these modules.

Conventional transmitters with 4 to 20 mA technology without HART protocol can also be connected.

All modules with HART come with diagnostics capability (channel and module diagnostics). The diagnostics and monitoring functions are directly available in SIMATIC PCS 7. They require no additional engineering. Plain text messages output on the operator station provide information on faults or changes in the HART parameter settings.

Homogenous integration in the SIMATIC Process Device Manager (PDM) and the PCS 7 Asset Management permit intuitive online diagnostics and parameterization of all connected field devices from a central position.

Function

HART is a serial transmission procedure with which additional parameter data such as measuring ranges, attenuation etc. can be sent to transmitters and actuators over a 4 to 20-mA current loop. The HART jobs for each channel can be remotely initiated over the PROFIBUS DP. This usually takes place from the central engineering system of the SIMATIC PCS 7 process control system per SIMATIC PDM.

The modules with HART have the following features:

- Connections compatible with the conventional analog modules of the ET 200M
- Additional communications possibility over the current loop
- 8 analog channels per module (2 analog channels with Ex modules)
- Each channel is a primary master of the HART protocol
- Selectable input range per channel (AI):
 - 0 to 20 mA (without HART function)
 - ± 20 mA (without HART function, not with Ex module)
 - 4 to 20 mA (with/without HART function)
- Selectable output range per channel (AO):
 - 0 to 20 mA (with/without HART function; in the case of Ex module, only without HART function)
 - 4 to 20 mA (with/without HART function)

Additional functions of the HART analog modules 6ES7 331-7TF01-0AB0 and 6ES7 332-8TF01-0AB0:

- Supplementary HART variables (up to 4 per channel, up to 8 per module) allow the transmission of additional values from/to the HART devices
- Modules can be operated in redundant mode (module and channel redundancy)

Parameterization

- For the analog input modules (AI), it is possible to parameterize e.g. conversion time, input range, limits, alarms, smoothing of measured values
- For the analog output modules (AO), it is possible to parameterize e.g. output range, response on stoppage of AS (CPU), diagnostics
- Remote parameterization (per PROFIBUS DP) of the HART transmitters and actuators with SIMATIC PDM
- It is still possible to parameterize the HART devices using an operator terminal (handheld).

Process I/O

ET 200M distributed I/O

Modules with HART

Technical specifications

You can find the detailed technical data of the modules with HART at the following points:

- Catalog IK PI (Catalog Section "Distributed I/Os") or
- on the Mall/CA 01 under "Distributed I/Os / ET 200M"

Selection and Ordering Data

Order No.

SM 331 HART analog input module Redundant design possible (module and channel redundancy) 8 inputs, 0/4 to 20 mA or ± 20 mA <ul style="list-style-type: none"> • Resolution: 15 bit + sign • Connection of 2-wire or 4-wire transmitters possible • HART (2-wire or 4-wire) • Wire break monitoring • Short-circuit-proof • Front connector required: 20-contact 	6ES7 331-7TF01-0AB0 B)
SM 332 HART analog output module Redundant design possible (module and channel redundancy) 8 outputs, 0/4 to 20 mA <ul style="list-style-type: none"> • Resolution: 15 bit + sign • For 2-wire actuators • HART (2-wire) • Wire break monitoring • Front connector required: 20-contact 	6ES7 332-8TF01-0AB0 B)
Ex analog input module with HART [EEx ib] 2 inputs, 0/4 to 20 mA in 2 channel groups <ul style="list-style-type: none"> • Individually floating channels • Resolution: 15 bit + sign • Connection of 2-wire or 4-wire transmitters possible • Wire break monitoring • Short-circuit-proof • HART (2-wire or 4-wire) • Front connector required: 20-contact 	6ES7 331-7TB00-0AB0 B)
Ex analog output module with HART [EEx ib] 2 outputs, 0/4 to 20 mA in 2 channel groups <ul style="list-style-type: none"> • Individually floating channels • Resolution: 12 bit + sign • For 2-wire actuators • Wire break monitoring • HART • Front connector required: 20-contact 	6ES7 332-5TB00-0AB0 B)

B) Subject to export regulations: AL: N, ECCN: EAR99H

Overview



The safety functions of the AS 414F/FH and AS 417F/FH automation systems are matched to the safety-related I/O modules (F-modules) of the ET 200M distributed I/O system. The F-signal modules (DI/DO/AI) in the ET 200M remote I/O stations are able to guarantee plant safety even in the event of a CPU failure. They are of redundant design, and can diagnose both internal and external faults. They carry out self-tests for this purpose, e.g. for short-circuit or wire breakage, and automatically monitor the discrepancy time defined in the parameter settings. They comply with the requirements up to SIL 3 (IEC 61508) or AK 6 (VDE 0801).

The input modules operate internally with single-channel evaluation (SIL 2 sensors), 2-out-of-2 evaluation (SIL 3 sensors) or 2-out-of-3 channel evaluation (only F-AI module). A safety response is triggered immediately there are any differences. The type of evaluation influences the number of usable inputs (channels). For example, only half of the existing inputs are available in the case of 2-out-of-2 channel evaluation.

The digital output modules enable safe disconnection through a second disconnect path in the event of a faulty output.

Selection and Ordering Data

Order No.

SM 326F failsafe digital input module for floating contacts

24 inputs, 24 V DC

Electrically isolated in groups of 12
Redundant design possible (module redundancy)

- 4 short-circuit-proof sensor power supplies, each for 6 channels, isolated in groups of 3
- External sensor power supply possible
- SIL 2: single-channel evaluation, 24 channels
- SIL 3: 2-out-of-2 evaluation on the module, 12 channels (adjustable discrepancy time)
- Short-circuit monitoring to L+
- Discrepancy monitoring
- Supports time stamping (SOE)
- Diagnostics inside module
- PROFIsafe telegram
- Front connector required: 40-contact

6ES7 326-1BK01-0AB0

8 inputs, NAMUR [Ex ib]

Isolated by channel
Redundant design possible (module redundancy)

- 8 short-circuit-resistant sensor power supplies, each for 1 channel, mutually isolated
- SIL 2: single-channel evaluation, 8 channels
- SIL 3: 2-out-of-2 evaluation on the module, 4 channels (adjustable discrepancy time)
- Wire break and short-circuit monitoring (for contacts with external resistor circuit)
- Discrepancy monitoring
- Diagnostics inside module
- PROFIsafe telegram
- Front connector required: 40-contact

6ES7 326-1RF00-0AB0

Process I/O

ET 200M distributed I/O

F modules

Selection and Ordering Data Order No.

SM 326F failsafe digital output, suitable for solenoid valves, DC contactors and signal lamps

10 outputs, 24 V DC, 2 A

Electrically isolated in groups of 5 (outputs with internal diode)
Redundant design possible (module and channel redundancy)

- SIL 2, SIL 3 parameterizable (10 channels)
- P/P-switching (for non-floating loads; ground and earth connected together)
- Wire break and short-circuit monitoring
- Diagnostics inside module
- PROFIsafe telegram
- Front connector required: 40-contact

6ES7 326-2BF01-0AB0

8 outputs, 24 V DC, 2 A

Electrically isolated in groups of 4

- SIL 2, SIL 3 parameterizable (8 channels)
- P/M-switching (for floating loads; ground and earth separate)
- Wire break and short-circuit monitoring
- Diagnostics inside module
- PROFIsafe telegram
- Front connector required: 40-contact

6ES7 326-2BF40-0AB0

SM 336F failsafe analog input module

6 inputs, 4 to 20 mA

Redundant design possible (module redundancy)

- Resolution 13 bit + sign
- Isolated from the backplane bus
- 2-wire or 4-wire connection
- SIL 2: two-channel evaluation, 6 sensors
- SIL 3: two-channel evaluation, 12 sensors (adjustable tolerance window)
- Wire break monitoring
- Tolerance monitoring between 2 sensors (SIL 3)
- Diagnostics inside module
- PROFIsafe telegram
- Front connector required: 40-contact

6ES7 336-1HE00-0AB0

Options

Isolating module

For F modules, 40 mm wide

- For isolation of F and standard modules in an ET 200M rack
- For signal isolation when using a copper bus connection (only F modules in a rack with IM 153-2)

6ES7 195-7KF00-0XA0

Isolating bus module

80 mm wide, for isolating module, when using an active backplane bus

6ES7 195-7HG00-0XA0

Options

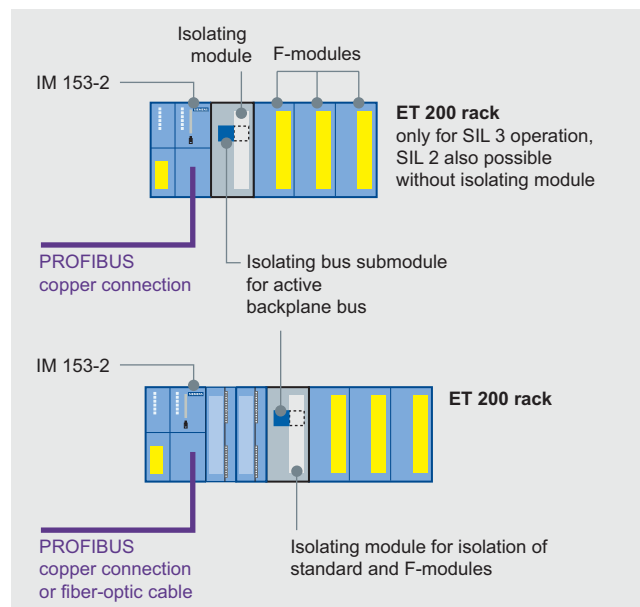

Isolating module

The following components are available as accessories for the F modules:

- Isolating module
 - For isolation of F and standard modules in an ET 200M remote I/O station
 - For signal isolation when using a copper bus connection (only F modules in an ET 200M remote I/O station with IM 153-2)
- Isolating bus submodule for isolating module, when using an active backplane bus

Note:

The isolating module for F modules and the isolating bus submodule can only be used together. The 40-mm wide gap cannot be used for other modules.

Overview



The FM 355 is an intelligent 4-channel controller module for universal control tasks. It can be used to control temperature, pressure and flow.

The following versions of the FM 355 are available:

- FM 355 C
Continuous-action controller with 4 analog outputs for controlling analog actuators
- FM 355 S
Step or pulse controller with 8 digital outputs for controlling motor-driven (integrating) actuators or binary controlled actuators (e.g. electrical heating strips and cartridges)
- FM 355-2 C/S
Specially optimized for temperature controls with user-friendly online self-optimization integrated

Function

The FM 355 / FM 355-2 modules have four separate control channels. These controllers have the following features:

- Predefined controller structures for
 - fixed-setpoint control,
 - cascade control,
 - ratio control,
 - 3-component control
- Various operating modes:
 - automatic mode,
 - manual mode,
 - safety mode,
 - follow-up mode,
 - backup mode
- Sampling interval (dependent on the resolution of the analog inputs and the compensation input):
 - at 12 bit: 20 ms to 100 ms (only FM 355-2)
 - at 14 bit: 100 ms to 500 ms (dependent on the number of enabled analog inputs)
- 2 control algorithms:
 - self-optimized temperature control algorithm,
 - PID algorithm
- Integrated online self-optimization without configuration (only FM 355-2)
 - for faster adoption of the operating point
- User-friendly controller optimization
- Backup mode: The controller can maintain its control function in the event of CPU failure or CPU stop. Programmable safety setpoint values or safety manipulated variables are set for this purpose.
- Feedforward control: The analog inputs can be optionally used for feedforward control as well as for actual value acquisition.

Process I/O

ET 200M distributed I/O

Closed-loop control modules

Integration

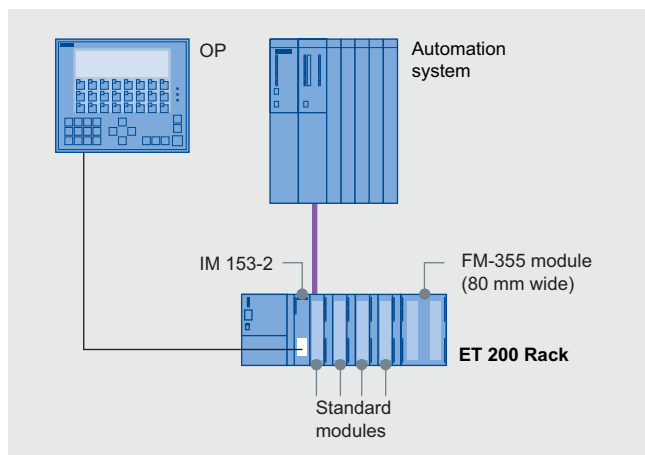

Use in SIMATIC PCS 7

The FM 355 / FM 355-2 modules can be used to implement control tasks outside the SIMATIC PCS 7 automation system. The modules have not only controller structures but also analog and digital channels, thus eliminating the need for additional modules to detect the setpoint/actual value or to control the actuator.

On the one hand this reduces the work load for the CPU, on the other hand it enables backup mode with which the control system continues to work even if the CPU fails. In this case the FM 355 module can be operated further with an OP operator panel (does not apply to FM 355-2).

The operator panel is connected to the PROFIBUS DP fieldbus for this purpose. The CPU of the automation system can surrender input privilege to the operator panel in normal operation as well. The parameters that can be accessed with the operator panel are the setpoint and manipulated variable. If the FM 355 module is operated from the operator panel, the automation system reads back the values accessible from the operator panel after the input privilege is withdrawn or recovered again. Bumpless continuation of the operations is thus assured.

IM 153-2 High Feature interface modules are needed for the PROFIBUS DP connection when the FM 355 / FM 355-2 controller modules are used in ET 200M.

PCS 7 blocks

CFC blocks with OS faceplates for all FM 355 modules are included in the scope of supply of the standard SIMATIC PCS 7 library (part of engineering software). These blocks are integrated into the PCS 7 driver concept. This guarantees homogenous system integration (including automatic diagnostics messages).

Parameterization in HW-Config

A configuration package containing all parameterization masks required for configuring, parameterizing and commissioning is included in the scope of supply of the FM 355 controller modules.

Selection and Ordering Data

Order No.

FM 355 C controller module

With 4 analog outputs for 4 continuous-action controllers

Required front connector:
2 x 20-pin

Incl. multi-lingual configuration package, manual and Getting Started (German, English, French, Italian) on CD-ROM

6ES7 355-0VH10-0AE0

FM 355 S controller module

With 8 digital outputs for 4 step or pulse controllers

Required front connector:
2 x 20-pin

Incl. multi-lingual configuration package, manual and Getting Started (German, English, French, Italian) on CD-ROM

6ES7 355-1VH10-0AE0

FM 355-2 C temperature controller module

With 4 analog outputs for 4 continuous-action controllers

Required front connector:
2 x 20-pin

Incl. multi-lingual configuration package, manual and Getting Started (German, English, French, Italian) on CD-ROM

6ES7 355-2CH00-0AE0

FM 355-2 S temperature controller module

With 8 digital outputs for 4 step or pulse controllers

Required front connector:
2 x 20-pin

Incl. multi-lingual configuration package, manual and Getting Started (German, English, French, Italian) on CD-ROM

6ES7 355-2SH00-0AE0

Note:

In the case of the FM 355 C and FM 355 S controller modules, the channels are not electrically isolated from one another

Overview



The FM 350-1 counter module is a single-channel intelligent counter module for simple counting tasks, suitable for the direct connection of incremental encoders. It provides a comparison function with 2 preselectable reference values, as well as integrated digital outputs for outputting a reaction upon reaching the reference value.

The FM 350-2 counter module is an eight-channel intelligent counter module for universal counting and measuring tasks, as well as for simple positioning jobs (max. 4 axes).

Selection and Ordering Data

Order No.

FM 350-1 counter module

Counting functions up to 500 kHz
1 channel for the connection of
5 V and 24 V incremental encod-
ers

Required front connector:
1 x 20-pin
incl. configuration package on
CD-ROM

6ES7 350-1AH03-0AE0

FM 350-2 counter module

8 channels with max. 20 kHz
counting frequency; for 24 V
encoders, for the following tasks:
counting, frequency measure-
ment, speed measurement,
period measurement, dosing

Required front connector:
1 x 40-pin
incl. configuration package on
CD-ROM

6ES7 350-2AH00-0AE0

Process I/O

ET 200iSP distributed I/O

Introduction

Overview



The ET 200iSP is a modular, intrinsically-safe I/O system in IP30 degree of protection, and can be configured with up to 32 electronics modules (4/8-channel). The range of electronics modules covers:

- 8-channel digital input module DI, can also be used as counter or frequency meter
- 4-channel digital output module DO with external actuator switch-off via High or Low signal (H/L switch-off)
- 4-channel analog input modules AI for temperature measurements with resistance thermometer or thermocouple
- 4-channel analog input modules AI for connection of 2/4-wire transmitters with or without HART functionality
- 4-channel analog output module AO for connection of field devices with or without HART functionality

The ET 200iSP suitable for gas and dust atmospheres according to the ATEX directive 94/9/EU can be installed directly in the Ex zones 1, 2, 21 or 22 as well as in non-hazardous areas. The intrinsically-safe sensors, actuators and HART field devices can also be located in zone 0 or 20 if necessary.

Design

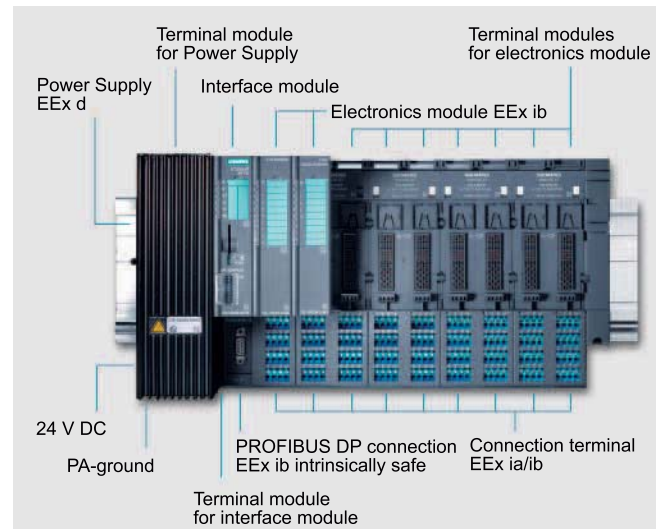

The ET 200iSP consists of the following components:

- Carrier system with terminal modules for prewiring, and also for inserting power supply, interface and electronics modules, mounted on an S7-300 rail
- 1 or 2 (redundant) power supply modules PS with pressurized enclosure
- 1 or 2 (redundant) IM 152 interface modules for PROFIBUS DP
- Up to 32 electronics modules (4/8-channel) in any combination, including watchdog module
- Terminating module (included in scope of delivery of terminal modules for the PROFIBUS interface)

Assembly is quick and easy:

- Latching of terminal modules onto the S7-300 rail
- Prewiring of process signal cables on the terminal modules using spring-loaded or screw-type connections
- Plugging-in of power supply, interface and electronics modules without the need for additional tools

The maximum number of electronics modules which can be used per station may be limited depending on the current consumption of the modules required to solve the automation task. However, up to 16 electronics modules can be used without limitation.

If the ET 200iSP is used in a hazardous area, it must be installed in an appropriate Ex housing which at least corresponds to the IP54 degree of protection. Appropriate versions of an IP65 housing are offered in the Section "Stainless steel wall housings".

Exceptional features of the ET 200iSP architecture

- Installation and testing of the wiring is possible in advance without the electronics module
- Isolation of the mechanical and electronic systems, in conjunction with the independent process wiring, permits fast and easy replacement of the electronics modules
- Mechanical coding which is carried out when an electronics module is plugged onto a terminal module for the first time prevents the connection of incorrect replacement modules
- Hot swapping of the power supply modules and electronics modules is possible without a fire certificate

Integration

Distributed ET 200iSP stations are connected to the SIMATIC PCS 7 automation systems (controllers) via the PROFIBUS DP, which can be routed intrinsically-safe into Ex zone 1 using an isolating transformer (RS485-iS coupler) as barrier. Data transfer rates of up to 1.5 Mbit/s are possible.

The modern architecture with independent wiring and automatic slot coding supports simple and reliable hot swapping of individual modules without a fire certificate. To increase plant availability, both the power supply and the PROFIBUS DP interface can be of redundant design.

The ET 200iSP is integrated into SIMATIC PCS 7 using standard driver blocks. You can therefore configure and parameterize the ET 200iSP in the SIMATIC Manager of the engineering system extremely simply using HW Config. The system function CiR (Configuration in Run) is also supported, and permits the following changes to be made to the configuration during runtime:

- Adding of an ET 200iSP station
- Adding of a module in an ET 200iSP station
- Reparameterization of modules.

Vendor-specific information and maintenance data are saved powerfail-proof on the electronics modules.

The existing standard diagnostics drivers preprocess the diagnostics messages generated by internal or external faults (e.g. wire breakage or short-circuit) as well as status messages of the connected HART field devices for the host operator system and the maintenance station of the PCS 7 asset management. The ET 200iSP and the HART field devices can also be parameterized using SIMATIC PDM (process device manager). With SIMATIC PDM you can directly access the HART field devices on the ET 200iSP by routing via PROFIBUS DP.

Technical specifications

Degree of protection	IP30
Ambient temperature	-20 ... +70 °C
Loading of media	According to ISA-S71.04 severity level G1; G2; G3 (except for NH3, only level G2 in this case)
EMC	Electromagnetic compatibility according to NE21
Vibration resistance	0.5 g continuously, 1 g occasionally

Approvals, standards

• ATEX	II 2 G (1) GD I M2	Ex de [ia/ib] IIC T4 Ex de [ia/ib] I
• IECEX	Zone 1	Ex de [ia/ib] IIC T4
• cFMus	Class I,II,II	NI Division 2, Groups A, B, C, D, E, F, G T4 AIS Division 1, Groups A, B, C, D, E, F, G
	Class I	Zone 1, AEx de [ia/ib] IIC T4
• cULus	Class I,II,II	Division 2, Groups A, B, C, D, E, F, G T4 providing int. safe circuits for Division 1, Groups A, B, C, D, E, F, G
	Class I	Zone 1, AEx de [ia/ib] IIC T4
• PROFIBUS	EN 50170, Volume 2	
• IEC	IEC 61131, Part 2	
• CE	According to 94/9/EU (ATEX 100a), 89/336/EEC and 73/23/EEC	
• Shipbuilding approval	Classification companies <ul style="list-style-type: none"> • ABS (American Bureau of Shipping) • BV (Bureau Veritas) • DNV (Det Norske Veritas) • GL (Germanischer Lloyd) • LRS (Lloyds Register of Shipping) • Class NK (Nippon Kaiji Kyokai) 	

For detailed technical specifications, especially on individual components such as power supply module, interface module or electronics modules, see:

- Catalog IK PI
- Mall/CA 01 under "Distributed I/Os / ET 200iSP"

Process I/O

ET 200iSP distributed I/O

ET 200iSP power supply unit

Overview



ET 200iSP power supply unit is the designation for the combination of one (standard) or two redundant power supply modules PS with the matching terminal module:

- Standard: TM-PS-A terminal module
- Redundancy: TM-PS-B terminal module (additionally)

Power supply modules and terminal modules must each be ordered separately.

Functions of the power supply modules

- They provide the ET 200iSP with the safely isolated operating voltages for
 - logic (via the backplane bus),
 - PROFIBUS DP interface (IM 152-1),
 - power bus (for powering the electronics modules).
- They handle the safety-related limitation of the output voltage.
- They have a pressurized metal enclosure (explosion protection EEx d).
- They can be operated in redundant mode.

Design

Depending on the operating mode (standard or redundant), one or two power supply modules are plugged onto the corresponding terminal modules. Hot swapping is also possible in the hazardous area.

The operating status of the power supply modules is displayed on two LEDs on the IM 152 interface module (one for each module).

The 24 V DC supply for the station is provided via EX e terminals on the terminal module of the power supply unit. This connection must not be removed in the hazardous area. The feeding power supply must be installed in the non-hazardous area.

The ET 200iSP must be terminated on the right-hand side (following the last electronics module) by a terminating module. The terminating module is included in the scope of delivery of the IM 152.

Selection and Ordering Data

	Order No.
Power supply module PS for ET 200iSP	6ES7 138-7EA01-0AA0
TM-PS-A terminal module for standard operation	6ES7 193-7DA10-0AA0 B)
TM-PS-B terminal module for redundant operation	6ES7 193-7DB10-0AA0 B)

B) Subject to export regulations: AL: N, ECCN: EAR99H

Overview



The IM 152 interface module connects the ET 200iSP to the PROFIBUS DP with intrinsically-safe RS 485-iS transmission technology with transmission rates up to 1.5 Mbit/s. A redundant connection is also possible. In this case the ET 200iSP is connected via two interface modules to two redundant PROFIBUS DP segments of a fault-tolerant automation system.

The IM 152 is plugged onto a special terminal module (to be ordered separately). The following terminal modules are available:

- TM-IM/EM60 terminal module for one interface module and one electronics module (with screw-type or spring-loaded terminals)
- TM-IM/IM terminal module for two interface modules (for redundant PROFIBUS DP connection)

Tasks of the IM 152 interface module

- Connection of ET 200iSP to the intrinsically-safe PROFIBUS DP
- Autonomous communication with the host automation system
- Preparation of data for the fitted electronic modules
- Saving of parameters of the electronics modules
- The IM 152 can assign a 20-ms time stamp to digital process signals.

The maximum address space of the interface module is 244 bytes for inputs, and 244 bytes for outputs.

Design

The terminal module of the IM 152 (TM-IM/EM or TM-IM/IM) is connected directly next to the power supply unit on the DIN rail. The PROFIBUS DP connection of the IM 152 is made using the standard Sub-D socket on the terminal module. The matching connection element we provide is a special terminating plug with selectable terminating resistance. The terminating resistance must be activated on the last ET 200iSP station of each PROFIBUS DP segment.

Hot swapping of the IM 152 and the PROFIBUS connector is permissible under hazardous conditions.

A terminating module is provided together with the IM 152, and must be fitted at the right end of each ET 200iSP station following the last electronics module.

The IM 152 has a slot for micro memory cards (MMC). The firmware can therefore be updated either via the PROFIBUS DP or using MMCs.

The PROFIBUS addresses can be set using DIL switches at the front which are protected by a cover.

LEDs on the front of the IM 152 signal the supply voltage, group faults, bus faults, the active IM with redundant operation, and the operating state of the fitted power supply modules.

Selection and Ordering Data

Order No.

IM 152-1 interface module for ET 200iSP incl. terminating module	6ES7 152-1AA00-0AB0
TM-IM/EM60 terminal module for ET 200iSP for one IM 152 module and one electronics module	
• TM-IM/EM60S (screw-type terminals)	6ES7 193-7AA00-0AA0 B)
• TM-IM/EM60S (spring-loaded terminals)	6ES7 193-7AA10-0AA0 B)
TM-IM/IM terminal module for ET 200iSP for two IM 152 modules (redundant operation)	6ES7 193-7AB00-0AA0
Accessories	
PROFIBUS connector with selectable terminating resistor for connection of IM 152 to PROFIBUS DP with RS 485-iS transmission technology	6ES7 972-0DA60-0XA0 B)
RS 485-iS coupler Isolating transformer for connection of PROFIBUS DP segments with RS 485 and RS 485-iS transmission technologies	6ES7 972-0AC80-0XA0
S7-300 rails	
• 585 mm long, suitable for assembly of ET 200iSP in a 650-mm wide wall housing	6ES7 390-1AF85-0AA0
• 885 mm long, suitable for assembly of ET 200iSP in a 950-mm wide wall housing	6ES7 390-1AJ85-0AA0

B) Subject to export regulations: AL: N, ECCN: EAR99H

For further accessories such as labeling strips or plates, see Catalog IK PI or the A&D Mall/CA 01 under "ET 200iSP distributed I/O".

Process I/O

ET 200iSP distributed I/O

Electronics modules and watchdog module

Overview



Electronics modules

The current range of electronics modules covers:

- 8-channel digital input module DI NAMUR, can also be used as counter or frequency meter
- 4-channel digital output module DO with external actuator switch-off via High or Low signal (H/L switch-off)
- 4-channel analog input modules AI for temperature measurements with resistance thermometer (RTD) or thermocouple (TC)
- 4-channel analog input modules AI for connection of 2/4-wire transmitters with or without HART functionality
- 4-channel analog output module AO for connection of field devices with or without HART functionality

A TC sensor module for internal temperature compensation is provided with the 4 AI TC module, and is fitted on the corresponding terminals of the associated terminal module. External compensation is possible for the 4 AI RTD module by connecting a Pt100.

The DO modules have a switch-off function which is triggered by an external signal (High or Low) from a switch-off device in the hazardous area. This permits implementation of an external switch-off independent of the automation system (controller). It is also possible to combine several DO modules into a switch-off group for this purpose. The intrinsically-safe power supply for the switch-off device is either via the watchdog module or a separate intrinsically-safe source.

Watchdog module

The watchdog module has two fundamental functions:

- Monitoring of the ET 200iSP remote I/O station for hardware failures (hardware lifebeat); external, applicative failure monitoring is also possible via an I/O address area of the module
- Intrinsically-safe power supply for external actuator switch-off

The watchdog module must be plugged onto a terminal module (order separately). The first slot directly next to the interface module is provided for the watchdog module. You can use the same terminal modules for the watchdog module as for the electronics modules.

Design

- The electronics modules are plugged as planned onto the corresponding terminal modules using screw-type systems (TM-EM/EM60S) or spring-loaded systems (TM-EM/EM60C). The terminal modules must be ordered in addition.
- The mechanical coding of the terminal module which is carried out when an electronics module is plugged on for the first time prevents the connection of incorrect replacement modules.
- Hot swapping of individual modules is possible under hazardous conditions.
- The process signals are connected to the terminals of the terminal modules assigned according to the plan, using either conventional screw-type or spring-loaded systems (conductor cross-sections 0.14 to max. 2.5 mm²) depending on the type of module.
- All electronics modules are implemented in the EEx i "intrinsically safe" degree of protection and can be easily replaced under hazardous conditions (hot swapping).
- Using a spare module plugged onto a terminal module for electronics modules (TM-EM/EM60S/ TM-EM/EM60C), you can reserve a slot for any electronics modules or close a gap resulting from the design. The spare module can be simply replaced by the electronics module at a later point in time.

Selection and Ordering Data	Order No.	Selection and Ordering Data	Order No.
Digital electronics modules Digital input modules 8 DI NAMUR For evaluation of NAMUR sensors, connected/non-connected contacts, as well as for recording counter pulses or measuring frequencies <ul style="list-style-type: none"> • 8 x NAMUR (NAMUR sensor on/off, NAMUR changeover contact) or connected/non-connected inputs (single/changeover contact) • 2 channels optionally usable as counters (max. 5 kHz) or frequency meters (1 Hz ... 5 kHz) • Time tagging 5 ms, rising or falling edge • Wire break monitoring • Short-circuit monitoring • Sensor power supply monitoring • Flutter monitoring 		6ES7 131-7RF00-0AB0 B)	
Digital output module with L switch-off (external actuator switch-off via L-signal); for switching of solenoid valves, DC relays, signal lamps, actuators 4 DO DC 23.1 V/20 mA <ul style="list-style-type: none"> • 4 channels with 20 mA each • Short-circuit monitoring • Wire break monitoring • Parameterizable connection of substitute value in case of CPU failure • Load-free switching of outputs via external intrinsically-safe signal 		6ES7 132-7GD00-0AB0 B)	
Digital output module with H switch-off (external actuator switch-off via H-signal); for switching of solenoid valves, DC relays, signal lamps, actuators 4 DO DC 23.1 V/20 mA <ul style="list-style-type: none"> • 4 channels with 20 mA each • Short-circuit monitoring • Wire break monitoring • Parameterizable connection of substitute value in case of CPU failure • Load-free switching of outputs via external intrinsically-safe signal 		6ES7 132-7RD01-0AB0 B)	
4 DO DC 17.4 V/27 mA <ul style="list-style-type: none"> • 4 channels with 27 mA each or • 2 outputs connected in parallel with 54 mA each • Short-circuit monitoring • Wire break monitoring • Parameterizable connection of substitute value in case of CPU failure • Load-free switching of outputs via external intrinsically-safe signal 		6ES7 132-7GD10-0AB0	
4 DO DC 17.4 V/40 mA <ul style="list-style-type: none"> • 4 channels with 40 mA each or • 2 outputs connected in parallel with 80 mA each • Short-circuit monitoring • Wire break monitoring • Parameterizable connection of substitute value in case of CPU failure • Load-free switching of outputs via external intrinsically-safe signal 		6ES7 132-7GD20-0AB0	
4 DO DC 17.4 V/27 mA <ul style="list-style-type: none"> • 4 channels with 27 mA each or • 2 outputs connected in parallel with 54 mA each • Short-circuit monitoring • Wire break monitoring • Parameterizable connection of substitute value in case of CPU failure • Load-free switching of outputs via external intrinsically-safe signal 		6ES7 132-7RD11-0AB0	
4 DO DC 17.4 V/40 mA <ul style="list-style-type: none"> • 4 channels with 40 mA each or • 2 outputs connected in parallel with 80 mA each • Short-circuit monitoring • Wire break monitoring • Parameterizable connection of substitute value in case of CPU failure • Load-free switching of outputs via external intrinsically-safe signal 		6ES7 132-7RD21-0AB0	

B) Subject to export regulations: AL: N, ECCN: EAR99H

Process I/O

ET 200iSP distributed I/O

Electronics modules and watchdog module

Selection and Ordering Data	Order No.
Analog electronics modules	
<u>Analog input modules</u>	
4 AI I 2 WIRE HART For measuring currents with 2-wire transmitters with/without HART functionality <ul style="list-style-type: none"> • 4 x 4 ... 20 mA, HART, 2-wire transmitter • Transmitter load: max. 750 Ω • Resolution 12 bit + sign • Short-circuit monitoring • Wire break monitoring 	6ES7 134-7TD00-0AB0 B)
4 AI I 4 WIRE HART For measuring currents with 4-wire transmitters with/without HART functionality <ul style="list-style-type: none"> • 4 x 0/4 ... 20 mA, HART, 4-wire transmitter • Transmitter load: max. 750 Ω • Resolution 12 bit + sign • Wire break monitoring 	6ES7 134-7TD50-0AB0
4 AI RTD For measuring resistances as well as for temperature measurements with resistance thermometers <ul style="list-style-type: none"> • 4 x RTD, resistance thermometer Pt100/Ni100 • 2-, 3-, 4-wire • Resolution 15 bit + sign • Short-circuit monitoring • Wire break monitoring 	6ES7 134-7SD50-0AB0
4 AI TC For measuring thermal e.m.f. as well as for temperature measurements with thermocouples <ul style="list-style-type: none"> • 4 x TC (thermocouples) • Type B [PtRh-PtRh] • Type N [NiCrSi-NiSi] • Type E [NiCr-CuNi] • Type R [PtRh-Pt] • Type S [PtPh-Pt] • Type J [Fe-CuNi] • Type L [Fe-CuNi] • Type T [Cu-CuNi] • Type K [NiCr-Ni] • Type U [Cu-CuNi] • Resolution 15 bit + sign • Internal temperature compensation possible using TC sensor module (included in scope of delivery of module) • External temperature compensation via PT100 connected to RTD module of same ET 200iSP station • Wire break monitoring 	6ES7 134-7SD00-0AB0

Selection and Ordering Data	Order No.
<u>Analog output modules</u>	
4 AO I HART For output of currents to field devices with/without HART functionality <ul style="list-style-type: none"> • 4 x 0/4 ... 20 mA, HART (max. load 750 Ω) • Resolution 14 bit • Short-circuit monitoring • Wire break monitoring • Parameterizable substitute value in case of CPU failure 	6ES7 135-7TD00-0AB0 B)
Watchdog module For failure monitoring and for the intrinsically-safe power supply of an external actuator switch-off	6ES7 138-7BB00-0AB0 B)
Terminal modules	
TM-EM/EM60S terminal module for ET 200iSP For two electronics modules, screw terminals	6ES7 193-7CA00-0AA0 B)
TM-EM/EM60C terminal module for ET 200iSP For two electronics modules, spring-loaded terminals	6ES7 193-7CA10-0AA0 B)
Accessories	
Reserve module For any electronics module	6ES7 138-7AA00-0AA0 B)
S7-300 rail <ul style="list-style-type: none"> • 585 mm long, suitable for assembly of ET 200iSP in a 650-mm wide wall housing • 885 mm long, suitable for assembly of ET 200iSP in a 950-mm wide wall housing 	6ES7 390-1AF85-0AA0 6ES7 390-1AJ85-0AA0

B) Subject to export regulations: AL: N, ECCN: EAR99H

For further accessories such as labeling strips or plates, see Catalog IK PI or the A&D Mall/CA 01 under "ET 200iSP distributed I/O".

Overview



Tasks of the RS 485-iS coupler

- Conversion of the electrical PROFIBUS DP RS 485 transmission technology into the intrinsically-safe RS 485-iS transmission technology with a transmission rate of 1.5 Mbit/s
- Required to connect intrinsically-safe PROFIBUS DP stations, e.g. ET 200iSP, ET 200iS or devices from other vendors with Ex i DP connection
- Functionality as a safety barrier
- Additional use as a repeater in the hazardous area
- Passive bus station (no configuration necessary)
- Certified according to ATEX 100a

Design

- The RS 485-iS coupler is an open unit; assembly is only permissible in housings, cabinets or rooms for electrical equipment.
- The RS 485-iS coupler is approved for use in hazardous areas of zone 2.
It must be fitted in a housing which at least corresponds to the IP54 degree of protection. A manufacturer's declaration for zone 2 (according to EN 50021) is required for the housing and the necessary cable glands.
- The RS 485-iS coupler can be used in a horizontal or vertical position.
- Installation is on a SIMATIC S7-300 rail.
- Diagnostics LEDs on the front panel signal the operating status.

Connection to PROFIBUS DP

- Connection to standard PROFIBUS DP via standard Sub-D socket (at the bottom on the RS 485-iS coupler, behind the right front door).

Integral bus connection for PROFIBUS DP with RS 485-iS transmission technology

- Connection of PROFIBUS DP with RS 485-iS transmission technology via screw terminals (at the top of the RS 485-iS coupler, behind the right front door)
- The last bus station on the intrinsically-safe PROFIBUS DP segment (not further RS 485-iS couplers) must be terminated by a selectable resistance using the connector, Order No. 6ES7 972-0DA60-0XA0.

Selection and Ordering Data

Order No.

RS 485-IS coupler

Isolating transformer for connection of PROFIBUS DP segments with RS 485 and RS 485-iS transmission technologies

6ES7 972-0AC80-0XA0

Accessories

PROFIBUS connector with selectable terminating resistor

For connection of IM 152 to PROFIBUS DP with RS 485-iS transmission technology

6ES7 972-0DA60-0XA0 B)

S7-300 rails

Lengths:

- 160 mm
- 482 mm
- 530 mm
- 830 mm
- 2000 mm

6ES7 390-1AB60-0AA0

6ES7 390-1AE80-0AA0

6ES7 390-1AF30-0AA0

6ES7 390-1AJ30-0AA0

6ES7 390-1BC00-0AA0

PROFIBUS Fast Connect bus cable

Standard type with special design for fast mounting, 2-core, shielded, cut-to-length; max. delivery unit 1000 m, minimum ordering quantity 20 m

6XV1 830-0EH10

B) Subject to export regulations: AL: N, ECCN: EAR99H

Process I/O

ET 200iSP distributed I/O

Stainless steel wall enclosure

Design

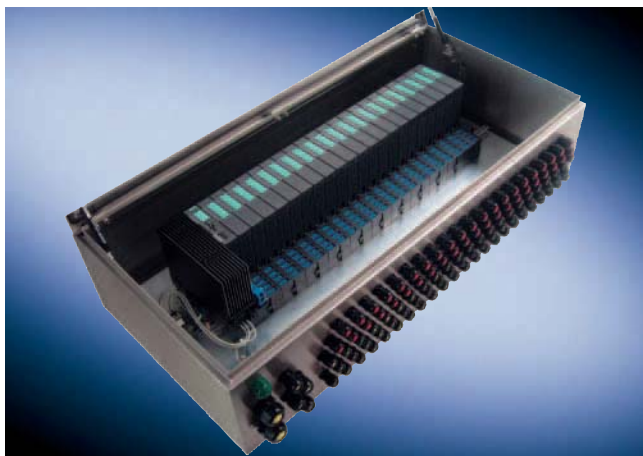

ET 200iSP modules can also be installed in stainless steel wall housings designed to meet more exacting protection requirements. The housings are available in three different sizes. They comply with degree of protection IP65 and can also be used in Ex zone 1.

Selection and Ordering Data

Stainless steel housing IP65 for Ex zone 1 in protection class EEx

Empty housing without installation of modules, for use in gaseous area, IP65

- Wall housing 650 x 450 x 230, for installation of max. 15 ET 200iSP modules, for use in gaseous area, with 3 rows of M16 cable glands (total 41) and 2 rows of blanking plugs
- Wall housing 650 x 450 x 230, for installation of max. 15 ET 200iSP modules, for use in gaseous area, with 5 rows of M16 cable glands (total 66)
- Wall housing 950 x 450 x 230, for installation of max. 25 ET 200iSP modules, for use in gaseous area, with 3 rows of M16 cable glands (total 68) and 2 rows of blanking plugs
- Wall housing 950 x 450 x 230, for installation of max. 25 ET 200iSP modules, for use in gaseous area, with 5 rows of M16 cable glands (total 111)

Empty housing without installation of modules, for use in dusty area, IP65

- Wall housing 650 x 450 x 230, for installation of max. 15 ET 200iSP modules, for use in dusty area, with 3 rows of M16 cable glands (total 41) and 2 rows of blanking plugs
- Wall housing 650 x 450 x 230, for installation of max. 15 ET 200iSP modules, for use in dusty area, with 5 rows of M16 cable glands (total 66)

6DL2 804-0AD30

6DL2 804-0AD50

6DL2 804-0AE30

6DL2 804-0AE50

6DL2 804-0DD30

6DL2 804-0DD50

Selection and Ordering Data

Order No.

- Wall housing 950 x 450 x 230, for installation of max. 25 ET 200iSP modules, for use in dusty area, with 3 rows of M16 cable glands (total 68) and 2 rows of blanking plugs

6DL2 804-0DE30

- Wall housing 950 x 450 x 230, for installation of max. 25 ET 200iSP modules, for use in dusty area, with 5 rows of M16 cable glands (total 111)

6DL2 804-0DE50

Housing with installation of ET 200iSP modules, for use in gaseous area, IP65 (IP54 when using an air-conditioning nozzle)¹⁾

- Wall housing 650 x 450 x 230, for installation of max. 15 ET 200iSP modules, for use in gaseous area, with 3 rows of M16 cable glands (total 41) and 2 rows of blanking plugs
- Wall housing 650 x 450 x 230, for installation of max. 15 ET 200iSP modules, for use in gaseous area, with 5 rows of M16 cable glands (total 66)

6DL2 804-1AD30

6DL2 804-1AD50

- Wall housing 950 x 450 x 230, for installation of max. 25 ET 200iSP modules, for use in gaseous area, with 3 rows of M16 cable glands (total 68) and 2 rows of blanking plugs

6DL2 804-1AE30

- Wall housing 950 x 450 x 230, for installation of max. 25 ET 200iSP modules, for use in gaseous area, with 5 rows of M16 cable glands (total 111)

6DL2 804-1AE50

Housing with installation of modules, for use in dusty area, IP65¹⁾

- Wall housing 650 x 450 x 230, for installation of max. 15 ET 200iSP modules, for use in dusty area, with 3 rows of M16 cable glands (total 41) and 2 rows of blanking plugs
- Wall housing 650 x 450 x 230, for installation of max. 15 ET 200iSP modules, for use in dusty area, with 5 rows of M16 cable glands (total 66)
- Wall housing 950 x 450 x 230, for installation of max. 25 ET 200iSP modules, for use in dusty area, with 3 rows of M16 cable glands (total 68) and 2 rows of blanking plugs
- Wall housing 950 x 450 x 230, for installation of max. 25 ET 200iSP modules, for use in dusty area, with 5 rows of M16 cable glands (total 111)

6DL2 804-1DD30

6DL2 804-1DD50

6DL2 804-1DE30

6DL2 804-1DE50

¹⁾ The ET 200iSP components have to be ordered separately

Overview

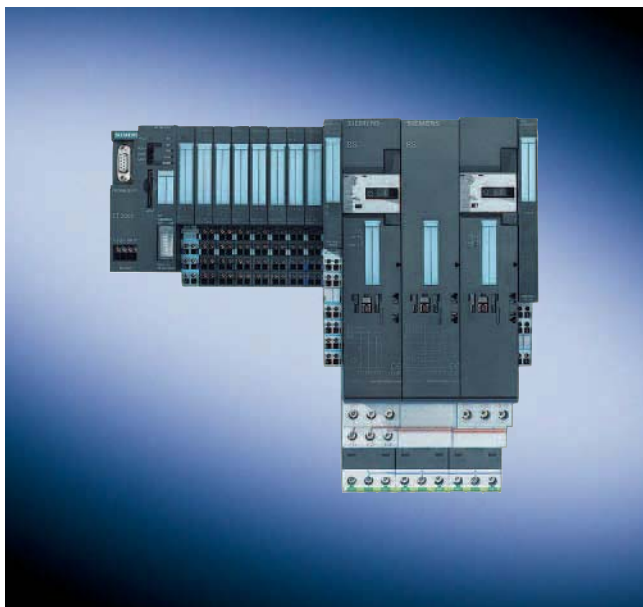

The ET 200S is a bit-modular distributed I/O system in IP 20 degree of protection and is approved for operation in Ex zone 2 or 22 (except for operation with motor starters). It is designed with independent wiring that supports the hot swapping of I/O modules (with fire certificate).

The range of I/Os that can be used with SIMATIC PCS 7 includes power modules for electronics modules and motor starters, analog and digital signal modules, and motor starters up to 7.5 kW.

The implementation of safety engineering applications is supported by:

- Safety-related F-components which are integrated in the SIMATIC Safety Integrated System, e.g. terminal, power and electronics modules as well as motor starters
- SIGUARD safety engineering for motor starter applications with conventional safety logic in plants of safety categories 2 to 4 (EN 954-1)

Note:

In addition to the selected modules, all other current ET 200S electronics modules can be used, but with limited functionality. Use of components from the SIPLUS extreme range in extended temperature ranges and under medial loading on request.

Design

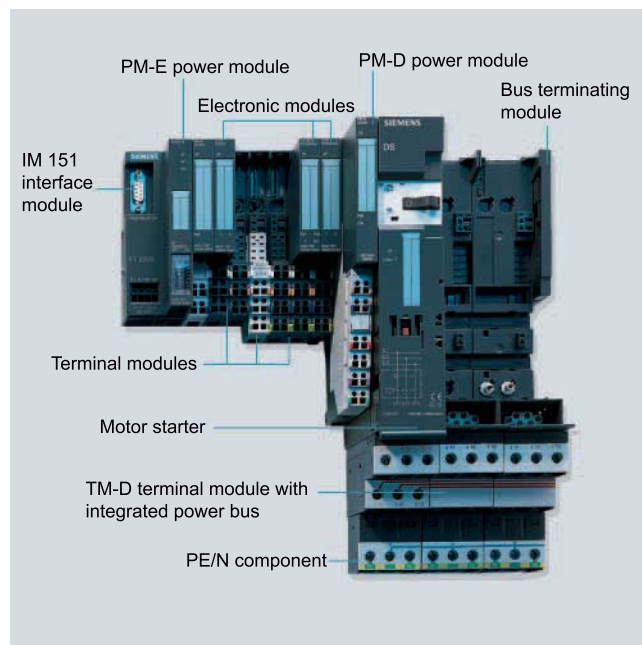

Main components of the ET 200S distributed I/O system:

- **Terminal modules** enable the electrical and mechanical connection of the I/O modules and carry the terminals for the process wiring:
 - TM-P terminal modules for power modules
 - TM-E terminal modules for electronics modules
 - TM-DS/TM-RS terminal modules for motor starters and TM-xB expansion modules
- **IM 151 interface module** for connecting the PROFIBUS DP to the ET 200S station. The terminal module is included in the scope of delivery.
- **Power modules** for PM-E electronics modules and PM-D motor starters
 - Individual grouping of load and sensor supply voltages and their monitoring, as well as for the safe shutting down of digital output modules
 - Supplying and monitoring the auxiliary voltages for motor starters, as well as for the shutting down of a complete group of motor starters
- **Electronics modules** for process data exchange
 - Digital electronics modules for connecting digital sensors and actuators
 - Analog electronics modules for connecting analog sensors and actuators
- **Motor starter modules** for switching and protecting any three-phase loads
- **Accessories**
 - Reserve module for reserving a slot for any electronics module
 - Label sheets for printing ID labels on a laser printer
 - Shield connection: shield connecting element, shield terminal, ground terminal, copper voltage bus 3 x 10 mm; components for the low-impedance connection of cable shielding at low cost of installation

Process I/O

ET 200S distributed I/O

Introduction

Mounting

The terminal modules that can be mounted on a DIN rail (35 x 15 x 7.5 or 15 mm) form the carrier system for the I/O modules. They are used for the process wiring and enable the electrical and mechanical connection of the I/O modules. The terminal modules can be prewired and tested without the I/O modules. The I/O modules are simply plugged in place later. Terminal modules are available with screw connections, spring-loaded terminals or FastConnect design for fast mounting.

The automatic coding of the I/O modules reliably prevents the risk of injury to persons and/or destruction of modules through accidental mounting of the wrong module.

Expansion limits

Depending on the IM 151 interface module used, the expansion of an ET 200S station is subject to the following limits:

- A maximum total of 63 I/O modules per station can be inserted between interface module and terminating module
- The maximum permissible width of an ET 200S station is 2 m
- The maximum address volume of all the inserted I/O modules is 244 byte for input data and 244 byte for output data
- The maximum number of parameters is restricted to 244 byte per station

ET 200S configuration

The SIMATIC ET 200 configurator can be used to compile an ET 200S station rapidly and simply. It knows the configuration rules, and supports selection of all components and associated accessories in interactive mode. The SIMATIC ET 200 is available in the current CD-ROM Catalog CA 01 and on the Internet.

Additional information is available in the Internet under:



<http://www.siemens.com/et200>

Technical specifications

Detailed technical data on the ET 200S can be found

- in the IK PI catalog or
- in the Mall / CA 01 at "Distributed I/Os / ET 200S"

Overview



- Terminal modules are mechanical modules for integrating the power and electronics modules as well as the motor starters and expansion modules (Ordering data of the terminal modules for motor starters and expansion modules can be found under "Motor starters")
- For constructing the independent wiring using self-assembling voltage buses
- Alternatively with screw-type or spring-loaded terminals and Fast Connect design
- Replaceable terminal box
- Automatic coding of the electronics modules
- Build-as-you-go shielding of the backplane bus for high data security
- Optional plug-in shield connection
- Color coding facility for the terminals and for identifying the slot numbers

Selection and Ordering Data

Order No.

Terminal Modules TM-P for Power Modules

TM-P15S23-A1 Terminal Module 2 x 3 terminals, terminal access to AUX1 bus, AUX1 interconnected to the left, screw-type terminals Ordering unit 1 piece	6ES7 193-4CC20-0AA0
TM-P15C23-A1 Terminal Module 2 x 3 terminals, terminal access to AUX1 bus, AUX1 interconnected to the left, spring-type terminals Ordering unit 1 piece	6ES7 193-4CC30-0AA0
TM-P15N23-A1 Terminal Module 2 x 3 terminals, terminal access to AUX1 bus, AUX1 interconnected to the left, Fast Connect Ordering unit 1 piece	6ES7 193-4CC70-0AA0
TM-P15S23-A0 Terminal Module 2 x 3 terminals, terminal access to AUX1 bus, AUX1 interrupted to the left, screw-type terminals Ordering unit 1 piece	6ES7 193-4CD20-0AA0
TM-P15N23-A0 Terminal Module 2 x 3 terminals, terminal access to AUX1 bus, AUX1 interrupted to the left, spring-type terminals Ordering unit 1 piece	6ES7 193-4CD30-0AA0
TM-P15N23-A0 Terminal Module 2 x 3 terminals, terminal access to AUX1 bus, AUX1 interrupted to the left, Fast Connect Ordering unit 1 piece	6ES7 193-4CD70-0AA0
TM-P15S22-01 Terminal Module 2 x 2 terminals, no terminal access to AUX1 bus, AUX1 interconnected to the left, screw-type terminals Ordering unit 1 piece	6ES7 193-4CE00-0AA0
TM-P15C22-01 Terminal Module 2 x 2 terminals, no terminal access to AUX1 bus, AUX1 interconnected to the left, spring-loaded terminals Ordering unit 1 piece	6ES7 193-4CE10-0AA0
TM-P15N22-01 Terminal Module 2 x 2 terminals, no terminal access to AUX1 bus, AUX1 interconnected to the left, Fast Connect Ordering unit 1 piece	6ES7 193-4CE60-0AA0
TM-P30S44-A0 Terminal Module 7 x 2 terminals, terminal access to AUX1 bus, AUX1 interrupted to the left, screw-type terminals for PM-E F PROFIsafe Ordering unit 1 piece	6ES7 193-4CK20-0AA0
TM-P30C44-A0 Terminal Module 7 x 2 terminals, terminal access to AUX1 bus, AUX1 interrupted to the left, spring-loaded terminals for PM-E F PROFIsafe Ordering unit 1 piece	6ES7 193-4CK30-0AA0

Process I/O

ET 200S distributed I/O

Terminal modules

Selection and Ordering Data

Order No.

TM-E Terminal Modules for Electronic Modules

TM-E15S24-A1 Terminal Module 2 x 4 terminals, terminal access to AUX1 bus, AUX1 interconnected to the left, screw-type terminals Ordering unit 5 pieces	6ES7 193-4CA20-0AA0
TM-E15C24-A1 Terminal Module 2 x 4 terminals, terminal access to AUX1 bus, AUX1 interconnected to the left, spring-type terminals Ordering unit 5 pieces	6ES7 193-4CA30-0AA0
TM-E15N24-A1 Terminal Module 2 x 4 terminals, terminal access to AUX1 bus, AUX1 interconnected to the left, Fast Connect Ordering unit 5 pieces	6ES7 193-4CA70-0AA0
TM-E15S24-01 Terminal Module 2 x 4 terminals, no terminal access to AUX1 bus, AUX1 interconnected to the left, screw-type terminals Ordering unit 5 pieces	6ES7 193-4CB20-0AA0
TM-E15C24-01 Terminal Module 2 x 4 terminals, no terminal access to AUX1 bus, AUX1 interconnected to the left, spring-loaded terminals Ordering unit 5 pieces	6ES7 193-4CB30-0AA0
TM-E15N24-01 Terminal Module 2 x 4 terminals, no terminal access to AUX1 bus, AUX1 interconnected to the left, Fast Connect Ordering unit 5 pieces	6ES7 193-4CB70-0AA0
TM-E15S23-01 Terminal Module 2 x 3 terminals, no terminal access to AUX1 bus, AUX1 interconnected to the left, screw-type terminals Ordering unit 5 pieces	6ES7 193-4CB00-0AA0
TM-E15C23-01 Terminal Module 2 x 3 terminals, no terminal access to AUX1 bus, AUX1 interconnected to the left, spring-loaded terminals Ordering unit 5 pieces	6ES7 193-4CB10-0AA0
TM-E15N23-01 Terminal Module 2 x 3 terminals, no terminal access to AUX1 bus, AUX1 interconnected to the left, Fast Connect Ordering unit 5 pieces	6ES7 193-4CB60-0AA0
TM-E15N26-A1 Terminal Module 2 x 6 terminals, terminal access to AUX1 bus, AUX1 interconnected to the left, Fast Connect Ordering unit 5 pieces	6ES7 193-4CA80-0AA0
TM-E15S26-A1 Terminal Module 2 x 6 terminals, terminal access to AUX1 bus, AUX1 interconnected to the left, screw-type terminals Ordering unit 5 pieces	6ES7 193-4CA40-0AA0
TM-E15C26-A1 Terminal Module 2 x 6 terminals, terminal access to AUX1 bus, AUX1 interconnected to the left, spring-type terminals Ordering unit 5 pieces	6ES7 193-4CA50-0AA0

Selection and Ordering Data

Order No.

TM-E30S44-01 Terminal Module 4 x 4 terminals, no terminal access to AUX1 bus, AUX1 interconnected to the left, screw-type terminals Ordering unit 1 piece	6ES7 193-4CG20-0AA0
TM-E30C44-01 Terminal Module 4 x 4 terminals, no terminal access to AUX1 bus, AUX1 interconnected to the left, spring-loaded terminals Ordering unit 1 piece	6ES7 193-4CG30-0AA0
TM-E30S46-A1 Terminal Module 4 x 6 terminals, terminal access to AUX1 bus, AUX1 interconnected to the left, screw-type terminals Ordering unit 1 piece	6ES7 193-4CF40-0AA0
TM-E30C46-A1 Terminal Module 4 x 6 terminals, terminal access to AUX1 bus, AUX1 interconnected to the left, spring-type terminals Ordering unit 1 piece	6ES7 193-4CF50-0AA0
TM-E15S24-AT Terminal Module For internal temperature compensation with 2AI TC High Feature, screw-type terminals Ordering unit 1 piece	6ES7 193-4CL20-0AA0
TM-E15C24-AT Terminal Module For internal temperature compensation with 2AI TC High Feature, spring-loaded terminals Ordering unit 1 piece	6ES7 193-4CL30-0AA0

Accessories for the terminal modules, see the IK PI catalog or A&D Mall / CA 01 at "Distributed I/Os / ET 200S"

Overview



- IM 151-1 high feature (RS 485)
- Interface module for electrical connection of the ET 200S to PROFIBUS DP using copper bus cables
- Handles all data exchange with the PROFIBUS DP master

Selection and Ordering Data

Order No.

IM151-1 interface module
for ET 200S, High Feature

6ES7 151-1BA02-0AB0 B)

B) Subject to export regulations: AL: N, ECCN: EAR99H

Process I/O

ET 200S distributed I/O

Power modules

Overview



PM-E power modules

- For all types of electronic modules (including safety-oriented electronic modules); limitations resulting from power supply with PM-E DC 24 V
- For monitoring and, depending on the version, fusing the voltage to electronic modules provided via the TM-P terminal module (load and sensor supply voltage)
- Diagnostics message for voltage and blown fuse (can be switched off per configuration)
- Two versions with different supply voltages:
 - PM-E DC 24 V (not for 2 DI AC 120 V, 2 DI AC 230 V and 2 DO AC 24 to 230 V)
 - PM-E DC 24 to 48 V; AC 24 to 230 V; with additional fuse

PM-E F power modules

- For all non-safety-oriented types of electronic modules with 24 V DC supply
- For monitoring the voltage to electronic modules provided via the TM-P terminal module (load and sensor supply voltage)
- For safe switching off of series-connected standard digital output modules 24 V DC (up to 10 A) via relay contacts (up to Cat. 3 according to EN 954 or SIL 2 according to IEC 61508):
 - 2 DO / 0.5 A standard, 6ES7 132-4BB01-0AA0
 - 2 DO / 2 A standard, 6ES7 132-4BB31-0AA0
 - 2 DO / 0.5 A high feature, 6ES7 132-4BB01-0AB0
 - 2 DO / 2 A high feature, 6ES7 132-4BB31-0AB0
 - 4 DO / 0.5 A standard, 6ES7 132-4BD01-0AA0
 - 4 DO / 2 A standard, 6ES7 132-4BD31-0AA0
- Two versions:
 - PM-E F pm DC 24 V PROFIsafe for ungrounded loads (separate ground and earth); with two additional safety-oriented digital outputs (p/m switching, up to Cat. 4 / SIL 3)
 - PM-E F pp DC 24 V PROFIsafe for grounded loads (ground and earth connected), e.g. actuators for connection to a central ground

Design

Depending on the possible combinations listed in the table, the power modules are plugged onto corresponding TM-P terminal modules. Power modules are suitable for dividing the ET 200S into potential groups. A power module must be provided at the beginning of each potential group. In addition, the first module following the IM 151-1 High Feature interface module must always be a power module.

The TM-P terminal module of the power module interrupts the voltage buses (P1/P2) and therefore opens up a new potential group. All sensor and load supplies of the downstream electronics modules are fed from the TM-P and monitored by the power module. The total current of all modules of a potential group is limited by the maximum current carrying capacity of the power module (up to 10 A depending on the voltage and temperature range; for details, refer to the technical specifications of the power modules in Catalog IK PI).

Possible combinations of the TM-P terminal modules and PM-E power modules

TM-P terminal modules for power modules				
Screw-type terminal	15S23-A1	15S23-A0	15S22-01	30S44-A0
6ES7 193-...	...4CC20 - 0AA0	...4CD20 - 0AA0	...4CE00- 0AA0	...4CK20- 0AA0
Spring terminal	TM-P15C23-A1	TM-P15C23-A0	TM-P15C22-01	TM-P30C44-A0
6ES7 193-...	...4CC30 - 0AA0	...4CD30 - 0AA0	...4CE10- 0AA0	...4CK30- 0AA0
Fast Connect	TM-P15N23-A1	TM-P15N23-A0	TM-P15N22-01	--
6ES7 193-...	...4CC70 - 0AA0	...4CD70 - 0AA0	...4CE60- 0AA0	
Power modules				
PM-E DC 24 V	•	•	•	
PM-E DC 24 ... 48 V/ AC 24 ... 230 V	•	•	•	
PM-E F DC 24 V PROFIsafe				•
PM-D F DC 24 V PROFIsafe				•

Selection and Ordering Data

Order No.

Power module PM-E for electronics modules

Power module PM-E

- 24 V DC / 10 A
 - Monitoring of the load voltage
- 24 ... 48 V DC; 24 ... 230 V AC
 - Monitoring of the fuse
 - Monitoring of the load voltage

6ES7 138-4CA01-0AA0 B)

6ES7 138-4CB11-0AB0 B)

Power module PM-E F

- PM-E F pm DC 24 V PROFIsafe
 - 1 x relay 24 V DC/10 A, P/M-switching, for switching-off series-connected standard digital output modules (up to AK 4, SIL 2)
 - 2 x 24 V DC/2 A, P/M-switching, with wire breakage monitoring by channel (with "1" signal)
 - Safe monitoring of communication with PROFIsafe
 - Diagnostics inside module
 - Overload diagnostics by channel
- PM-E F pp DC 24 V PROFIsafe
 - 1 x relay 24 V DC/10 A, P/P-switching, for switching-off series-connected standard digital output modules (up to AK 4, SIL 2)
 - Safe monitoring of communication with PROFIsafe
 - Diagnostics inside module
 - Overload diagnostics by channel

6ES7 138-4CF02-0AB0 B)

6ES7 138-4CF41-0AB0 B)

B) Subject to export regulations: AL: N, ECCN: EAR99H

Overview



- 2- and 4-channel digital inputs and outputs for the ET 200S
- Can be plugged onto TM-E terminal modules with automatic coding.
- High-feature versions for enhanced plant availability, additional functions and comprehensive diagnostics
- Hot swapping of modules possible
- Safety-related digital input module 4/8 F-DI PROFIsafe
- Safety-related digital output module 4 F-DO PROFIsafe 24 V DC/2 A
- Isolated from the backplane bus

Design

Possible combinations of the TM-E terminal modules and digital modules

TM-E terminal modules for electronics modules							
Screw-type terminal Order No. 6ES7 193...	TM-E15S26-A1 ...4CA40-0AA0	TM-E15S24-A1 ...4CA20-0AA0	TM-E15S24-01 ...4CB20-0AA0	TM-E15S23-01 ...4CB00-0AA0	TM-E15S24-AT ...4CL20-0AA0	TM-E30S44-01 ...4CG20-0AA0	TM-E30S46-A1 ...4CF40-0AA0
Spring terminal Order No. 6ES7 193...	TM-E15C26-A1 ...4CA50-0AA0	TM-E15C24-A1 ...4CA30-0AA0	TM-E15C24-01 ...4CB30-0AA0	TM-E15C23-01 ...4CB10-0AA0	TM-E15C24-AT ...4CL30-0AA0	TM-E30C44-01 ...4CG30-0AA0	TM-E30C46-A1 ...4CF50-0AA0
Fast Connect Order No. 6ES7 193...	TM-E15N26-A1 ...4CA80-0AA0	TM-E15N24-A1 ...4CA70-0AA0	TM-E15N24-01 ...4CB70-0AA0	TM-E15N23-01 ...4CB60-0AA0	--	--	--
Electronics modules							
2DI 24 V DC Standard	•	•	•	•			
2DI 24 V DC High Feature							
4DI 24 V DC Standard							
4DI 24 V DC High Feature							
4DI 24 ... 48 V AC/DC High Feature	•	•	•	•			
4 DI NAMUR	•	•	•	•			
2DI 120 V AC Standard	•	•	•	•			
2DI 230 V AC Standard	•	•	•	•			
2 DO 24 V DC/0.5 A Standard	•	•	•	•			
2 DO 24 V DC/0.5 A High Feature							
4 DO 24 V DC/0.5 A Standard							
2 DO 24 V DC/2 A Standard	•	•	•	•			
2 DO 24 V DC/2 A High Feature							
4 DO 24 V DC/2 A Standard							
2 DO 24 ... 230 V AC/2 A	•	•	•	•			
2RO, 24 ... 120 V DC/5 A, 24 ... 230 V AC/5 A	•	•	•	•			
2RO, 24 ... 48 V DC/5 A, 24 ... 230 V AC/5 A							
4/8 failsafe DI 24 V DC ¹⁾						•	•
4 failsafe DO 24 V DC/2 A ¹⁾						•	•
Reserve (width 15 mm)	•	•	•	•	•		
Reserve (width 30 mm)						•	•

¹⁾ See Manual "ET 200S failsafe modules" in the documentation packages "S7 F Systems" and "S7 Distributed Safety"

Process I/O

ET 200S distributed I/O

Digital electronics modules

Selection and Ordering Data

Digital inputs for floating contacts

Ordering unit	Order No.	
DI 2 x 24 V DC, standard Ordering unit 5 items	6ES7 131-4BB01-0AA0	B)
DI 4 x 24 V DC, standard Ordering unit 5 items	6ES7 131-4BD01-0AA0	B)
DI 2 x 24 V DC, High Feature; with diagnostics • Short-circuit monitoring Ordering unit 5 items	6ES7 131-4BB01-0AB0	B)
DI 4 x 24 V DC, High Feature; with diagnostics • Short-circuit monitoring Ordering unit 5 items	6ES7 131-4BD01-0AB0	
DI 4 x 24 to 48 V AC/DC, High Feature; with diagnostics • Wire break monitoring (external resistance circuit required) • Monitoring of the fuse • Monitoring of the load voltage Ordering unit 5 items	6ES7 131-4CD00-0AB0	B)
DI 4 x 24 V DC, NAMUR Ordering unit 1 item	6ES7 131-4RD00-0AB0	B)
DI 2 x 120 V AC, standard Ordering unit 5 items	6ES7 131-4EB00-0AB0	B)
DI 2 x 230 V AC, standard Ordering unit 5 items	6ES7 131-4FB00-0AB0	B)

Failsafe digital input

4/8 F-DI 24 V DC PROFIsafe 8 DI safety-related SIL 2 or 4 DI safety-related SIL 3, with diagnos- tics • Cyclic short-circuit test • Discrepancy monitoring of 2 channels for SIL 3 (adjustable discrepancy time) • Safe monitoring of communica- tion with PROFIsafe Ordering unit 1 item	6ES7 138-4FA03-0AB0	B)
---	---------------------	----

Digital outputs for DC voltage (suitable for solenoid valves, DC contactors, indicator lights etc.)

DO 2 x 24 V DC/0.5 A, standard Ordering unit 5 items	6ES7 132-4BB01-0AA0	B)
DO 2 x 24 V DC/2 A, standard Ordering unit 5 items	6ES7 132-4BB31-0AA0	
DO 2 x 24 V DC/0.5 A, High Feature, with diagnostics • Connection of a default value by channel in the event of CPU fail- ure (parameterizable) • Short-circuit monitoring by channel • Broken wire monitoring by chan- nel (when "1" signal) Ordering unit 5 items	6ES7 132-4BB01-0AB0	B)

Selection and Ordering Data

Ordering unit	Order No.	
DO 2 x 24 V DC/2 A, High Fea- ture, with diagnostics • Connection of a default value by channel in the event of CPU fail- ure (parameterizable) • Short-circuit monitoring by channel • Broken wire monitoring by chan- nel (when "1" signal) Ordering unit 5 items	6ES7 132-4BB31-0AB0	B)
DO 4 x 24 V DC/0.5 A, standard Ordering unit 5 items	6ES7 132-4BD01-0AA0	
DO 4 x 24 V DC/2 A, standard Ordering unit 5 items	6ES7 132-4BD32-0AA0	B)

Digital output for AC voltage (suitable for solenoid valves, AC contactors, indicator lights etc.)

DO 2 x 24 to 230 V AC, 2 A • Connection of a default value by channel in the event of CPU fail- ure (parameterizable) Ordering unit 5 items	6ES7 132-4FB01-0AB0	B)
---	---------------------	----

Relay output (suitable for solenoid valves, contactors, motor starters, miniature motors and indicator lights)

2 x RO, NO contact 24 to 120 V DC/5 A 24 to 230 V AC/5 A • Connection of a default value by channel in the event of CPU fail- ure (parameterizable) Ordering unit 5 items	6ES7 132-4HB01-0AB0	
2 x RO, changeover contact 24 to 48 V DC/5 A 24 to 230 V AC/5 A • Connection of a default value by channel in the event of CPU fail- ure (parameterizable) Ordering unit 5 items	6ES7 132-4HB10-0AB0	B)

Failsafe digital output

4 F-DO 24 V DC/2 A PROFIsafe Safety-related up to SIL 3, with diagnostics, switching to low/high • Short-circuit monitoring by channel • Overload monitoring by channel • Broken wire monitoring by chan- nel (when "1" signal) • Safe monitoring of communica- tion with PROFIsafe • Diagnostics inside module Ordering unit 1 item	6ES7 138-4FB02-0AB0	B)
---	---------------------	----

Accessories

Reserve modules for ET 200S

for reserving unused slots for any
electronics module

• 15 mm wide (Ordering unit 5 items)	6ES7 138-4AA01-0AA0	B)
• 30 mm wide (Ordering unit 1 item)	6ES7 138-4AA11-0AA0	B)

For further accessories, e.g. for
labeling, see Catalog IK PI

B) Subject to export regulations: AL: N, ECCN: EAR99H

11

Overview



- Analog inputs and outputs for the ET 200S
- Can be plugged onto TM-E terminal modules with automatic coding.
- High-feature variants with enhanced accuracy and resolution
- Hot swapping of modules possible

Design

Possible combinations of the TM-E terminal modules and analog modules

TM-E terminal modules for electronics modules					
Screw-type terminal Order No. 6ES7 193...	TM-E15S26-A1 ...4CA40-0AA0	TM-E15S24-A1 ...4CA20-0AA0	TM-E15S24-01 ...4CB20-0AA0	TM-E15S23-01 ...4CB00-0AA0	TM-E15S24-AT ...4CL20-0AA0
Spring terminal Order No. 6ES7 193...	TM-E15C26-A1 ...4CA50-0AA0	TM-E15C24-A1 ...4CA30-0AA0	TM-E15C24-01 ...4CB30-0AA0	TM-E15C23-01 ...4CB10-0AA0	TM-E15C24-AT ...4CL30-0AA0
Fast Connect Order No. 6ES7 193...	TM-E15N26-A1 ...4CA80-0AA0	TM-E15N24-A1 ...4CA70-0AA0	TM-E15N24-01 ...4CB70-0AA0	TM-E15N23-01 ...4CB60-0AA0	--
Electronics modules					
2AI U Standard	•	•	•	•	
2AI U High Feature					
2AI I 2WIRE Standard	•	•	•	•	
2AI I 2/4WIRE High Feature	•		•		
2 AI I 4WIRE Standard	•		•		
2AI RTD Standard	•		•		
2AI RTD High Feature	•	•	•	•	
2 AI TC Standard	•	•	•	•	
2 AI TC High Feature					•
2AO U Standard	•		•		
2AO U High Feature					
2 AO I Standard	•	•	•	•	
2AO I High Feature					

Process I/O

ET 200S distributed I/O

Analog electronics modules

Selection and Ordering Data

Order No.

Analog input

- AI 2 x U (± 5 V, 1 ... 5 V, ± 10 V) / 13 bit, standard
- Module-internal diagnostics
- Overflow/underflow diagnostics
6ES7 134-4FB01-0AB0
- AI 2 x I, 2-wire transmitter (4 ... 20 mA) / 13 bit, standard
- Module-internal diagnostics
- Overflow/underflow diagnostics
- Wire break monitoring
6ES7 134-4GB01-0AB0 B)
- AI 2 x I, 4-wire transmitter (± 20 mA, 4 ... 20 mA) / 13 bit, standard
- Module-internal diagnostics
- Overflow/underflow diagnostics
- Wire break monitoring
6ES7 134-4GB11-0AB0 B)
- AI 2 x TC / 15 bit, standard
- Module-internal diagnostics
- Overflow/underflow diagnostics
- Wire break monitoring
- Compensation through external Pt100 in the same station with AI 2 x RTD standard
6ES7 134-4JB00-0AB0 B)
- AI 2 x RTD / 15 bit, standard
- Module-internal diagnostics
- Overflow/underflow diagnostics
- Wire break monitoring
- Resistance thermometer Pt100, Ni100 (2, 3 or 4 wires)
6ES7 134-4JB50-0AB0 B)
- AI 2 x U (1...5 V, ± 5 V, ± 10 V) / 15 bit, High Feature
- Module-internal diagnostics
- Overflow/underflow diagnostics
6ES7 134-4LB02-0AB0 B)
- AI 2 x I, 2/4-wire transmitter (± 20 mA, 4 ... 20 mA) / 15 bit, high feature
- Module-internal diagnostics
- Overflow/underflow diagnostics
- Wire break monitoring
6ES7 134-4MB02-0AB0 B)
- AI 2 x TC / 15 bit, high feature
- Module-internal diagnostics
- Overflow/underflow diagnostics
- Wire break monitoring
- Internal temperature compensation with TM-E15S24-AT or TM-E15C24-AT terminal module
6ES7 134-4NB01-0AB0 B)
- AI 2 x RTD / 15 bit, high feature
- Module-internal diagnostics
- Overflow/underflow diagnostics
- Wire break monitoring
- Resistance thermometer Pt100/200/500/1000, Ni100/1000 (2, 3 or 4 wires)
- Temperature in Celsius or Fahrenheit
6ES7 134-4NB51-0AB0 B)

Selection and Ordering Data

Order No.

Analog output

- AO 2 x U (1...5 V / 12 bit, ± 10 V / 13 bit), standard
- Module-internal diagnostics
- Connection of substitute value in event of CPU stop (parameterizable)
- Short-circuit monitoring
6ES7 135-4FB01-0AB0 B)
- AO 2 x I (± 20 mA, 4 ... 20 mA) / 13 bit, standard
- Module-internal diagnostics
- Connection of substitute value in event of CPU stop (parameterizable)
- Wire break monitoring
6ES7 135-4GB01-0AB0 B)
- AO 2 x U (1 ... 5 V, ± 10 V) / 15 bit, high feature
- Module-internal diagnostics
- Connection of substitute value in event of CPU stop (parameterizable)
- Short-circuit monitoring
6ES7 135-4LB02-0AB0 B)
- AO 2 x I (± 20 mA, 4 ... 20 mA) / 15 bit, high feature
- Module-internal diagnostics
- Connection of substitute value in event of CPU stop (parameterizable)
- Wire break monitoring
6ES7 135-4MB02-0AB0 B)

Accessories

Reserve modules for ET 200S
for reserving unused slots for any electronics module

- 15 mm wide (5 units)
- 30 mm wide (1 unit)

6ES7 138-4AA01-0AA0 B)**6ES7 138-4AA11-0AA0** B)

For further accessories, e.g. for labeling, see Catalog IK PI

B) Subject to export regulations: AL: N, ECCN: EAR99H

Overview



- Completely factory-wired motor starters for switching and protecting any three-phase loads
- Can be used as a direct-on-line, reversing or soft starter
- High Feature motor starter with a combination comprising starter circuit breaker, solid-state overload protection and contactor or soft starter up to 7.5 kW
- Safety-oriented motor starters based on the High Feature motor starters (direct-on-line and reversing starters) with integral redundancy function for shutdown reliability up to Category 4 (EN 954-1)
- With self-assembling 50 A power bus, i.e. the load current is only supplied once for a group of motor starters
- Hot swapping is permissible
- Inputs and outputs for activating and signaling the states have been integrated
- Diagnostics capability for active monitoring of the switching and protection functions
- Can be combined with brake control module for controlling electromechanical brakes in three-phase motors

Design

Power modules and motor starters are operated on the terminal modules which are assigned to them in the tables in the sections "High Feature motor starters" and "Safety-oriented motor starters". The terminal modules are a carrier system which is simultaneously used for the power supply to the motor starters (electronics: 24 V DC and load: 400 V AC).

24 V DC for the electronics is provided by the power module inserted to the left of the first motor starter. The power module and the downstream motor starters constitute a potential group whose scope is limited by the current carrying capacity of the power module. When this limit is reached, a new potential group must be established with a further power module.

The load current is applied to the first (left) TM-xxxxS32 motor starter terminal module, and reaches the other motor starters via the power bus of the adjacent TM-xxxxS31 terminal modules. The power bus is designed for loads up to 50 A. When this limit is reached, a new load group must be started with a further TM-xxxxS32 terminal module, and provided with load current.

Brake control modules for motor starters

High Feature and safety-oriented motor starters can be expanded by a brake control module for controlling electromechanical brakes in three-phase motors. The following modules are available:

- For brakes with external supply 24 V DC/4 A:
 - xB3 (with two optional inputs for special functions)
 - xB1
- For brakes with internal supply 500 V DC/0.7 A:
 - xB4 (with two optional inputs for special functions)
 - xB2

The externally supplied 24 V DC brakes can be released independent of the switching status of the motor starter. The 500 V DC brakes, on the other hand, are generally supplied direct from the junction plate of the motor via a rectifier module and cannot be released if the motor starter is switched off. These brakes cannot be used in conjunction with the DSS1e-x motor starter (direct-on-line soft starter).

The outputs of the brake control modules can also be used for other purposes e.g. for controlling DC valves. Independent special functions can be implemented with the help of two optional local inputs each on a brake control module xB3 or xB4 and a control module 2DI of the High Feature motor starter. These operate independently of the bus and higher-level control, e.g. to implement rapid stop functions for slide controls.

Brake control modules are operated on different terminal modules depending on the design:

Brake control modul	Terminal module for brake control module	
xB1 oder xB2	TM-xB15S24-01 3RK1 903-0AG00	--
xB3 oder xB4	--	TM-xB215S24-01 3RK1 903-0AG01

Process I/O

ET 200S distributed I/O

Motor starters

High Feature motor starters

The High Feature motor starters are used together with the PM-D power module. Combined with a terminal module according to the table, a PM-D power module opens up a new potential group. The scope of the group is limited in that the value specified for the current carrying capacity of the power module (10 A for PM-D) must not be exceeded by the total current of all modules in a potential group.

The PM-D handles the following tasks for the motor starters in a potential group:

- Supply of voltages for the electronics via the voltage buses of the terminal modules
- Monitoring of voltages for the electronics and contactors

Terminal modules for motor starters and power modules			
With power bus supply for one load group, including 3 caps for termination of power bus	TM-DS65-S32 3RK1 903-0AK00	TM-RS130-S32 3RK1 903-0AL00	--
With power bus bushing	TM-DS65-S31 3RK1 903-0AK10	TM-RS130-S31 3RK1 903-0AL10	--
With screw terminals	--	--	TM-P15-S27-01 3RK1 903-0AA00

Power module			
PM-D 24 V DC			•
Motor starters			
DS1e-x High Feature direct-on-line starter	•		
DSS1e-x High Feature direct-on-line soft starter	•		
RS1e-x High Feature reversing starter		•	

Safety-oriented motor starters

In EMERGENCY STOP applications, safety-oriented motor starters can be shut down selectively by means of the upstream PM-D F PROFIsafe power module. Up to 6 shut-down groups can be formed per power module. The PM-D F PROFIsafe obtains the shut-down signal from the F/FH automation system via the interface module of the ET 200S.

Combined with a terminal module according to the table, a PM-D F PROFIsafe power module opens up a new potential group. The scope of the group is limited in that the total current of all modules in a potential group must not exceed the current carrying capacity of the power module (with PM-D F PROFIsafe: inrush current 10 A; continuous current 5 A).

Terminal modules for motor starters, power modules and supplementary/expansion modules			
With power bus supply for one load group, including 3 caps for termination of power bus	TM-FD65-S32 3RK1 903-3AC00	TM-FRS130-S32 3RK1 903-3AD00	--
With power bus bushing	TM-FD65-S31 3RK1 903-3AC10	TM-FRS130-S31 3RK1 903-3AD10	--
With screw terminals	--	--	TM-PF30S47-F0 3RK1 903-3AA00

Power module			
PM-D F PROFIsafe			•
Motor starters			
F-DS1e-x	•		
High Feature direct-on-line starter			
F-RS1e-x		•	
High Feature reversing starter			

Supplementary/expansion modules for safety-oriented motor starter applications

The PM-D F X1 power/expansion module permits selective shut-down of 1 to 6 shut-down groups through external safety devices (e.g. safety relay or AS-i safety monitor). The PM-D F X1 uses the safety-oriented shut-down signals connected to the module to trigger the downstream failsafe motor starters which then safely switch off the assigned motors.

In addition, external safety devices can also be powered by a safe 24 V DC voltage V_1 via the safety-oriented PM-D F X1 power/expansion module.

The F-CM contact multiplier equipped with four safe floating contacts (NO contacts) can be used together with the PM-D F PROFIsafe or the PM-D F X1 as an interface to plants with conventional safety engineering. It has internal diagnostics functions, and can be set to one of 6 shut-down groups.

Terminal modules for supplementary/expansion modules		
Without supply from left (as power module)	TM-PFX30 S47-G1 3RK1 903-3AE00	--
With supply from left (for expansion)	TM-PFX30 S47-G0 3RK1 903-3AE10	--
	--	TM-FCM30-S47 3RK1 903-3AB10

Additional/expansion modules		
PM-D F X1 safety-oriented power/expansion module	•	
F-CM safety-oriented contact multiplier		•

Selection and Ordering Data	Order No.
High Feature motor starters With diagnostics, expandable with brake control module	
DS1e-x direct-on-line starters Mechanical switching, electronic overload protection	
• Up to 1.1 kW/400 V; 0.3 to 3.0 A	3RK1 301-0AB10-0AA4
• Up to 3.0 kW/400 V; 2.4 to 8.0 A	3RK1 301-0BB10-0AA4
• Up to 7.5 kW/400 V; 2.4 to 16.0 A	3RK1 301-0CB10-0AA4
DSS1e-x soft starters Electronic switching, electronic overload protection	
• Up to 1.1 kW/400 V; 0.3 to 3.0 A	3RK1 301-0AB20-0AA4
• Up to 3.0 kW/400 V; 2.4 to 8.0 A	3RK1 301-0BB20-0AA4
• Up to 7.5 kW/400 V; 2.4 to 16.0 A	3RK1 301-0CB20-0AA4
RS1e-x reversing starters Mechanical switching, electronic overload protection	
• Up to 1.1 kW/400 V; 0.3 to 3.0 A	3RK1 301-0AB10-1AA4
• Up to 3.0 kW/400 V; 2.4 to 8.0 A	3RK1 301-0BB10-1AA4
• Up to 7.5 kW/400 V; 2.4 to 16.0 A	3RK1 301-0CB10-1AA4
Accessories	
Terminal modules for motor starters	
• TM-DS65-S32 for DS1e-x, DSS1e-x direct starters with supply connection for power bus, incl. 3 caps for terminating the power bus	3RK1 903-0AK00 A)
• TM-DS65-S31 for DS1e-x, DSS1e-x direct starters without supply connection for power bus	3RK1 903-0AK10 A)
• TM-RS130-S32 for RS1e-x reversing starter with supply connection for power bus, incl. 3 caps for connecting the power bus	3RK1 903-0AL00 A)
• TM-RS130-S31 for RS1e-x reversing starter without supply connection for power bus	3RK1 903-0AL10 A)
PM-D power module for direct and reversing starters; 24 V DC, with diagnostics	3RK1 903-0BA00 A)
Terminal module for PM-D power module TM-P15-S27-01	3RK1 903-0AA00
Jumper modules	
• M15-PEN Terminal block PE/N, 15 mm wide, for jumpering a 15-mm module	3RK1 903-0AH00
• M30-PEN Terminal block PE/N, 30 mm wide, for jumpering a 30-mm module	3RK1 903-0AJ00
• M15-L123 Terminal block L1/L2/L3, 15 mm wide, for jumpering a 15-mm module	3RK1 903-0AE00
• M30-L123 Terminal block L1/L2/L3, 30 mm wide, for jumpering a 30-mm module	3RK1 903-0AF00

Selection and Ordering Data	Order No.
Control modules	
• Control module 2DI COM DC 24 V Digital input module with two inputs for parameterizable motor starters, for mounting on front of motor starter, with PC connection (LOGO! PC cable 6ED1057-1AA00-0AB0 required)	3RK1 903-0CH10 A)
• Control module 2DI LC COM DC 24 V Like control module 2DI COM, plus input for switching to manual local mode	3RK1 903-0CH20 A)
M65-PEN-F infeed module 65 mm wide, incl. two caps, in combination with TM-DS65-32/TM-RS130-S32	3RK1 903-2AC00
M65-PEN-S connection module 65 mm wide, in combination with TM-DS65-31/TM-RS130-S31	3RK1 903-2AC10
Brake control expansion module For motors with mechanical brake	
• xB1 24 V DC / 4 A	3RK1 903-0CB00 A)
• xB2 500 V DC / 0.7 A	3RK1 903-0CC00
• xB3 24 V DC / 4 A, DI 2 x 24 V DC with two optional inputs	3RK1 903-0CE00 A)
• xB4 500 V DC / 0.7 A, DI 2 x 24 V DC with two optional inputs	3RK1 903-0CF00 A)
Terminal modules for brake control expansion module	
• TM-xB15S24-01 for xB1 or xB2	3RK1 903-0AG00
• TM-xB215S24-01 for xB3 or xB4	3RK1 903-0AG01 A)

A) Subject to export regulations: AL: N, ECCN: EAR99

Process I/O

ET 200S distributed I/O

Motor starters

Selection and Ordering Data

Order No.

Safety-related motor starters

With diagnostics, expandable with brake control module

F-DS1e-x safety-related direct starter

Mechanical switching, electronic overload protection

- Up to 1.1 kW/400 V; 0.3 to 3.0 A
- Up to 3.0 kW/400 V; 2.4 to 8.0 A
- Up to 7.5 kW/400 V; 2.4 to 16.0 A

3RK1 301-0AB13-0AA4

3RK1 301-0BB13-0AA4

3RK1 301-0CB13-0AA4

F-RS1e-x safety-related reversing starter

Mechanical switching, electronic overload protection

- Up to 1.1 kW/400 V; 0.3 to 3.0 A
- Up to 3.0 kW/400 V; 2.4 to 8.0 A
- Up to 7.5 kW/400 V; 2.4 to 16.0 A

3RK1 301-0AB13-1AA4

3RK1 301-0BB13-1AA4

3RK1 301-0CB13-1AA4

Accessories

Terminal modules for safety-related motor starters

- For F-DS1e-x direct starter, with coding

- TM-FDS65-S32 with supply connection for power bus

3RK1 903-3AC00 A)

- TM-FDS65-S31 without supply connection for power bus

3RK1 903-3AC10 A)

- For F-RS1e-x reversing starter, with coding

- TM-FRS130-S32 with supply connection for power bus

3RK1 903-3AD00 A)

- TM-FRS130-S31 without supply connection for power bus

3RK1 903-3AD10 A)

PM-D F PROFIsafe power module

for direct and reversing starters; 24 V DC, with diagnostics

3RK1 903-3BA01 A)

Terminal module for PM-D F PROFIsafe power module

TM PF30 S47-F0

3RK1 903-3AA00 A)

Jumper modules and control modules

See under High Feature motor starters

M65-PEN-F infeed module

65 mm wide, incl. two caps, in combination with TM-DS65-32 / TM-RS130-S32

3RK1 903-2AC00

M65-PEN-S connection module

65 mm wide, in combination with TM-DS65-31/TM-RS130-S31

3RK1 903-2AC10

Selection and Ordering Data

Order No.

Brake control expansion module

For motors with mechanical brake

- **xB3**
24 V DC / 4 A, DI 2 x 24 V DC with two optional inputs

3RK1 903-0CE00 A)

- **xB4**
500 V DC / 0.7 A, DI 2 x 24 V DC with two optional inputs

3RK1 903-0CF00 A)

Terminal modules for brake control expansion module

TM-xB215S24-01 for xB3 or xB4

3RK1 903-0AG01 A)

PM-D F X1 power module

For power supply of emergency stop signals of external safety units; for 6 switch-off groups, 24 V DC

3RK1 903-3DA00 A)

Terminal module for PM-D F X1 power module

- **TM-PFX30 S47-G0**
With infeed on left

3RK1 903-3AE10 A)

- **TM-PFX30 S47-G1**
Without infeed on left

3RK1 903-3AE00 A)

F-CM contact multiplexer

With 4 safe floating contacts

3RK1 903-3CA00

Terminal module for F-CM contact multiplexer

TM-FCM30 S47-F01

3RK1 903-3AB10

A) Subject to export regulations: AL: N, ECCN: EAR99

Note:

For color-coded labels and further accessories for ET 200S configurations with High Feature motor starters and for ET 200S configurations with safety-related motor starters, refer to "Distributed I/Os / ET 200S" in the A&D Mall or in the Catalogs IK PI and CA 01.

Overview



The SIGUARD safety system is based on special terminal and power modules that can be combined with the ET 200S motor starters and a failsafe kit to achieve the highest safety category 4 (according to EN 954-1). It enables the evaluation of emergency stop circuits, the monitoring of protective doors or the implementation of time-delayed shut-downs. The costs involved in the configuration and wiring of conventional safety systems are no longer incurred. All standard safety applications can be covered with SIGUARD (see the ET 200S manual for examples of applications).

Design

Components required for applications with safety requirements

Components required	Safety category acc. to EN 954-1		
	2	3	4
PM-D F1...5	•	•	• ¹⁾
TM-PF30 S47-..	•	•	•
F-Kit 1/2	• ²⁾	• ²⁾	• ²⁾
PM-X	•	•	•
TM-X15 S27-01	•	•	•
Redundantly switching, external infeed contactor		•	•

¹⁾ PM-D F3 power module only approved up to Category 3

²⁾ F kit required for standard motor starter only; already integrated in high feature motor starter

Possible combinations of power and terminal modules

	PM-D F1	PM-D F2	PM-D F3	PM-D F4	PM-D F5	PM-X
TM-PF30 S47-B1 ¹⁾	•	•				
TM-PF30 S47-B0 ²⁾	•	•				
TM-PF30 S47-C1 ³⁾			•	•		
TM-PF30 S47-C0 ⁴⁾			•	•		
TM-PF30 S47-D0					•	
TM-X15 S27-01						•

¹⁾ For F1 or F2 in higher-level or individual safety group (voltage group)

²⁾ For F1 or F2 in lower-level cascaded safety group (partial voltage group)

³⁾ For expansion with F3 or F4 in separate ET 200S station (voltage group)

⁴⁾ For expansion with F3 or F4 in the same ET 200S station (partial voltage group)

Process I/O

ET 200S distributed I/O

SIGUARD safety technology

Terminal modules for SIGUARD power modules

The terminal modules integrate the SIGUARD power modules. Using different terminal modules it is possible to separate various safety circuits by function or else to cascade them. Each such group has to be terminated with a SIGUARD PM-X connection module.

- The TM-PF30 S47-B1 terminal module always stands at the beginning of a safety segment and integrates either the PM-D F1 power module for emergency stop applications or the PM-D F2 power module for protective door monitoring. The 2-channel connection of the safety sensor (e.g. emergency stop button) as well as the 24 V DC supply for the electronics (V_1) and the contactor supply (V_2) of the motor starters have to be connected to this terminal module. Connections for the ON button (enable) and the safe output of the power module are also available.
- The TM-PF30 S47-B0 terminal module is used for the cascading of subordinate safety segments and integrates either the PM-D F1 power module for emergency stop applications or the PM-D F2 power module for protective door monitoring. No additional auxiliary voltage has to be connected to this terminal module. The supply is fed through the terminal module voltage buses from the preceding PM-D F1 or PM-D F2 power module. Switching off the voltage of the preceding power module means that the terminal module has no voltage either.
- The TM-PF30 S47-C1 terminal module always stands at the beginning of an expansion of a safety segment in a new station, e.g. in an interlaced configuration. It integrates the PM-D F3 power module for time-delayed shut-down or the PM-D F4 power module for direct shut-down in physically separated ET 200S stations. The 24-V voltages for the electronics (V_1) and for the contactor supply (V_2) are provided again. The shut-down command of a preceding ET 200S station is integrated through a safe input. Separate terminals are available for connecting the feedback circuit to the upstream ET 200S station. It is not possible to connect safety sensors to this terminal module.
- The TM-PF30 S47-C0 terminal module is used to cascade subordinate safety segments and integrates either the PM-DF3 power module for time-delayed shut-down or the PM-DF4 power module. Only the supply voltage V_2 for the contactor supply need be connected on this terminal module. The supply with V_1 is via the voltage buses of the terminal modules of the previous power modules (partial voltage group). It is not possible to connect safety sensors to this terminal module.
- The TM-PF30 S47-D0 terminal module is used to integrate the PM-D F5 power module. At this terminal module it is possible to forward safe signals to external systems through four groups, each with two safety relay contacts in redundant configuration. The terminal module must always be positioned between one of the above mentioned terminal modules and a terminal module for the TM-X connection module. It is not possible to connect safety sensors to this terminal module.

TM-X terminal module for SIGUARD connection module

For connecting an external incoming supply contactor (second shut-down option) in Categories 3 and 4. The SIGUARD connection module is inserted to the right of the last motor starter in a safety segment. The terminals for connecting the positively driven NC contact of the contactor are located alongside the terminals for connecting the contactor coil on the TM-X terminal module. If no redundant contactor is required in Category 2 (EN 954-1), for example, the feedback circuit has to be closed at these terminals by a jumper. This arrangement is also used instead of SIGUARD power module as an interface to the external safety relay when external safety relays are used.

SIGUARD PM-D F1/F2/F3/F4/F5 power modules

The following SIGUARD PM-D power modules are available for selection:

- PM-D F1 for evaluating emergency stop circuits with the function "Monitored start".
- PM-D F2 for monitoring safety doors with the function "Automatic start".
- PM-D F3 as expansion for PM-D F1/F2 for time-delayed tripping.
- PM-D F4 for expanding safety circuits with other ET200S motor starters, e.g. on a different tier.
- PM-D F5 for transmitting the status of PM-D F1...4 over four floating relay circuits to external safety devices (contact multipliers)

No additional PM-S power module is required when using the SIGUARD power modules. SIGUARD PM-D F1/F2/F3/F4 power modules monitor auxiliary voltages and contain the complete functionality of a safety relay. The PM-D F1 and PM-D F2 modules can be combined with the PM-D F3 or PM-D F4 modules. A PM-D F5 can be arranged in any position between PM-D F1...4 and a PM-X.

Every safety circuit, starting with a PM-D F1 ... 4, has to be terminated with a PM-X.

Failsafe kit

Every standard motor starter in a safety segment has to be supplemented by the failsafe kit (F-kit) in order to monitor the switching function. F-kit 1 supplements the DS1-x direct-on-line starter, F-kit 2 the RS1-x reversing starter.

The F-kits comprise

- contact carriers for the terminal modules,
- one or two auxiliary switch blocks for the contactor(s) of the motor starter and
- connecting lines.

High feature motor starters and their terminal modules come equipped with the F-kit functions.

Selection and Ordering Data	Order No.
SIGUARD Terminal Modules	
PM-PF30 S47 B1 Terminal Module For PM-D F1/2 power modules with U1/U2 incoming supply and sensor connection	3RK1 903-1AA00 A)
PM-PF30 S47 B0 Terminal Module For PM-D F1/2 power modules with sensor connection	3RK1 903-1AA10 A)
PM-PF30 S47 C1 Terminal Module For PM-D F3/4 power modules with U1/U2 incoming supply and IN+/IN- control input	3RK1 903-1AC00 A)
PM-PF30 S47 C0 Terminal Module For PM-D F3/4 power modules with U2 incoming supply	3RK1 903-1AC10
PM-PF30 S47 D0 Terminal Module For PM-D F5 power modules	3RK1 903-1AD10
PM-X15 S27 01 Terminal Module For SIGUARD connection module	3RK1 903-1AB00 A)
SIGUARD Power Modules	
PM-D F1 SIGUARD Power Module EMERGENCY STOP; monitored start; 2-channel	3RK1 903-1BA00
PM-D F2 SIGUARD Power Module Protective door; autostart; 2-channel	3RK1 903-1BB00
PM-D F3 SIGUARD Power Module Expansion to F1/2 for an additional voltage group; time-delayed	3RK1 903-1BD00
PM-D F4 SIGUARD Power Module Expansion to F1/2 for an additional voltage group	3RK1 903-1BC00
PM-D F5 SIGUARD Power Module Expansion to PM-D F1 up to PM-D F4, contact multiplier	3RK1 903-1BE00

Selection and Ordering Data	Order No.
Accessories	
PM-X SIGUARD Connection module for incoming-feeder contactor; external safety circuits	3RK1 903-1CB00 A)
Failsafe kit 1 Failsafe kit for DS1-x standard motor starter (not necessary for High Feature motor starter)	3RK1 903-1CA00 A)
Failsafe kit 2 Failsafe kit for RS1-x standard motor starter (not necessary for High Feature motor starter)	3RK1 903-1CA01 A)

A) Subject to export regulations: AL: N, ECCN: EAR99

Process I/O

Dezentrale Peripherie ET 200pro

Introduction

Overview



SIMATIC ET 200pro is a modular I/O system with high IP65/66/67 protection suitable for use at machine level outside the control cabinet. As a result of the innovative design, the ET 200pro has a relatively small size and can be flexibly adapted to the requirements of the respective automation task with regard to the connection system and I/Os. Summary of the most important features of the SIMATIC ET 200pro:

- Distributed I/O system with IP65/67 protection for use without a control cabinet at machine level
- Small, multi-functional complete solution: analog and digital I/O modules as well as safety-related digital I/O modules
- Communication over PROFIBUS DP, transmission rate up to 12 Mbit/s
- Mixed design of fail-safe and standard modules possible in the same station
- Free selection of connection system: direct, ECOFAST or M12 7/8"
- Power module for simple implementation of load groups
- Hot swapping of modules
- Simple assembly and independent wiring
- Comprehensive diagnostics: exact to the module or channel

Design

The architecture of the ET 200pro is based on the proven separation of modules from the bus/power supply connection system. This permits the T functionality for bus and 24 V DC power supply for the interface module, and prewiring of sensor/actuator connections for the electronics modules (independent wiring). When servicing, the independent wiring permits hot swapping of an electronics module without having to switch off the remaining station. This can continue without interruption during the replacement. When replacing an electronics module, the complete I/O wiring remains on the connection module, and need be neither labeled nor removed.

Up to 16 electronics modules can be arranged in any order between the interface module (left) and the terminating module (right limit).

Modules of an ET 200pro station

The ET 200pro modules are usually designed in two or three parts. Interface and power modules as well as digital and analog electronics modules comprise:

- Bus module as mechanical and electrical connection element of the individual ET 200pro modules (they form the backplane bus of the system)
- Electronics or interface module
- Connection module

The ET 200pro modules are fitted when delivered on the associated bus module.

An ET 200pro station comprises:

- Module support
- Interface module for PROFIBUS DP
- Connection module for the PROFIBUS DP interface module
 - CM IM DP direct with up to 6 M20 cable glands
 - CM IM DP ECOFAST Cu
 - CM IM DP M12 7/8"
- Max. 16 electronics modules with associated connection modules which may be assembled up to a station width of 1 m
- Terminating module (included in scope of delivery of interface module)

Expansion modules

The following expansion modules are available:

- Digital electronics modules
- Analog electronics modules
- Safety-related electronics modules
- I/O connection modules
 - CM IO 4 x M12 for digital or analog electronics modules
 - CM IO 8 x M12 for digital electronics modules
 - CM IO 12 x M12 for 4/8 F-DI/4 F-DO
 - CM IO 16 x M12 for 8/16 F-DI
- Power module electronics PM-E
- Connection modules for power module
 - CM PM-E direct with up to 2 M20 cable glands
 - CM PM-E ECOFAST Cu
 - CM PM-E 7/8"

Module support

Various module supports are available for mounting the ET 200pro:

- **Narrow module support**
The narrow module support permits complete preassembly on a workbench as a result of two mounting flanges outside the ET 200pro station.



- **Compact-narrow module support**
The compact-narrow module support permits the most space-saving design.



Expansion limits

- Number of electronics modules per station (between interface module and terminating module): up to 16
- Max. width (without module support): 1 m
- Electronics/sensor supply 1L+ max. 5 A per ET 200pro station
- Load voltage supply 2L+ max. 10 A per potential group
- Maximum address range of an ET 200pro station: 244 bytes for inputs and 244 bytes for outputs

ET 200pro configuration

The SIMATIC ET 200 configurator can be used to compile an ET 200pro station rapidly and simply. It knows the configuration rules, and supports selection of all components and associated accessories in interactive mode. The SIMATIC ET 200 is available in the current CD-ROM Catalog CA 01 and on the Internet.

Additional information is available in the Internet under:



<http://www.siemens.com/et200>

Integration

The distributed ET 200pro system is connected to SIMATIC PCS 7 automation systems (controllers) over PROFIBUS DP. Data transfer rates of up to 12 Mbit/s are possible.

The ET 200pro is integrated into SIMATIC PCS 7 using standard driver blocks. You can therefore configure and parameterize the ET 200pro in the SIMATIC Manager of the engineering system extremely simply using HW-Config.

Process I/O

Dezentrale Peripherie ET 200pro

Introduction

Technical specifications

General technical specifications

Electronics modules	<ul style="list-style-type: none"> • Digital inputs/outputs • Analog inputs/outputs • Safety-related digital inputs/outputs
Connection system for actuator/sensor	M12 round plug connection with standard assignments for actuator/sensor
Data transfer rate, max.	12 Mbit/s (PROFIBUS DP)
Power supply	24 V DC
Current consumption of an ET 200pro (internal and sensor supply, non-switched voltage), up to 55 °C, max.	≤ 5 A
Load current for ET 200pro per incoming supply (IM, PM, switched voltage), up to 55 °C, max.	10 A
For total configuration with looping through (several ET 200pro), up to 55 °C, max.	16 A (with direct connection module)
Degree of protection	IP65/66/IP67 for interface, digital and analog modules
Material	Thermoplast (glass-fiber reinforced)

Ambient conditions

Temperature	0 ... 55 °C (-25 °C on request)
Relative humidity	5 ... 100 %
Atmospheric pressure	795 ... 1080 hPa

Mechanical stress

Vibrations	<p>Vibration test according to IEC 60068, Part 2-6 (sinusoidal)</p> <ul style="list-style-type: none"> • Constant acceleration 5 g, occasionally 10 g, for interface, digital and analog modules • 2 g for motor starters
Shock	<ul style="list-style-type: none"> • Shock test according to IEC 680068 Part 2-27, half-sine, 30 g, 18 ms duration for interface, digital and analog modules • 15 g, 11 ms duration for motor starters
Approvals	UL, CSA and cULus

For detailed technical specifications, especially for individual components such as interface module, power module and electronics modules, see:

- Catalog IK PI
- Mall/CA 01 under "Distributed I/Os / ET 200pro"

Process I/O

Dezentrale Peripherie ET 200pro

Interface module IM 154-2 DP High Feature

Overview



The IM 154-2 DP High Feature interface module is responsible for PROFIBUS communication between the ET 200pro station and the host automation system (controller) as PROFIBUS DP master. The scope of delivery of the interface module also includes a terminating module which is plugged in following the last electronics module of the station.

Function

Features of the IM 154-2 DP High Feature interface module

- Mounted on delivery on the bus module
- Connects the ET 200pro station to the PROFIBUS DP via the connection module
- Prepares the data for the connected electronics modules
- Max. 16 electronics modules can be operated on an interface module - also safety-related
- PROFIBUS DP address of the ET 200pro station can be set on the connection module
- Terminating resistor of the PROFIBUS DP can be switched on and off on the connection module
- Maximum address range: 244 bytes for inputs and 244 bytes for outputs
- Powers the ET 200pro station via the connection module with the sensor/electronics supply 1L+ and the load power supply 2L+
- Integral power module for the load power supply 2L+

Technical specifications

For detailed technical specifications of the interface module, see:

- Catalog IK PI
- Mall/CA 01 under "Distributed I/Os / ET 200pro"

Accessories

Connection modules

The connection module for the IM 154-2 DP High Feature interface module (to be ordered separately) is available in three different connection versions:

- CM IM DP direct
- CM IM DP ECOFAST Cu
- CM IM DP M12 7/8"

The PROFIBUS address can be set on the connection module per DIL switch. The segmenting terminating resistor can be connected using a further DIL switch.

Selection and Ordering Data

Order No.

IM154-2 High Feature interface module for ET 200pro; for communication between ET 200pro and host masters over PROFIBUS DP; support of PROFI-safe	6ES7 154-2AA00-0AB0	B)
Connection module for IM154-2 High Feature interface module <ul style="list-style-type: none"> • CM IM DP ECOFAST connection module for connection of PROFIBUS DP and 24 V DC power supply to PROFIBUS interface modules, 2 ECOFAST Cu connections 	6ES7 194-4AA00-0AA0	B)
<ul style="list-style-type: none"> • CM IM DP direct connection module for direct connection of PROFIBUS DP and 24 V DC power supply to PROFIBUS interface modules, up to six M20 cable glands 	6ES7 194-4AC00-0AA0	B)
<ul style="list-style-type: none"> • CM IM DP M12 7/8" connection module for connection of PROFIBUS DP and 24 V DC power supply to PROFIBUS interface modules, 2 x M12 and 2 x 7/8" 	6ES7 194-4AD00-0AA0	B)

Cables and further accessories

For cables and further accessories for CM IM DP ECOFAST, CM IM DP direct and CM IM DP M12 7/8" connection modules, see Catalog IK PI or Mall/CA 01 under "Distributed I/O / ET 200pro"

General accessories

ET 200pro module support

- Narrow, for interface, electronics and power modules
 - 500 mm
 - 1000 mm
 - 2000 mm, can be cut to length
- Compact-narrow, for interface, electronics and power modules
 - 500 mm
 - 1000 mm
 - 2000 mm, can be cut to length

Spare fuse

12.5 A fast-blow, for interface and power modules, 10 units per pack

6ES7 194-4GA00-0AA0

6ES7 194-4GA60-0AA0

6ES7 194-4GA20-0AA0

6ES7 194-4GC70-0AA0

6ES7 194-4GC60-0AA0

6ES7 194-4GC20-0AA0

6ES7 194-4HB00-0AA0

B) Subject to export regulations: AL: N, ECCN: EAR99H

Process I/O

Dezentrale Peripherie ET 200pro

Digital electronics modules EM 141, EM 142

Overview



The following digital electronics modules can be used for connecting actuators/sensors in the context of SIMATIC PCS 7:

Digital input modules

- EM 8 DI DC 24 V High Feature
 - Digital electronics module with eight inputs
 - Suitable for standard switches and proximity switches (BEROs)
 - Rated input voltage 24 V DC
 - Diagnostics "Short-circuit of sensor supply to ground" per channel
 - Diagnostics "Open-circuit" per channel
 - Process alarm
 - Parameterizable input delay

Digital output modules

- EM 4 DO DC 24 V; 2 High Feature
 - Digital electronics module with four outputs
 - Suitable for solenoid valves, DC contactors and indicator lights
 - Output current 2 A per output
 - Rated load voltage 24 V DC
 - Diagnostics "Short-circuit of outputs to ground" per channel
 - Diagnostics "Short-circuit of outputs to P" per channel
 - Diagnostics "Open-circuit in outputs" per channel
 - Diagnostics "Load voltage missing" per module
 - Parameterizable substitute value

Technical specifications

For detailed technical specifications of the digital electronics modules, see:

- Catalog IK PI
- Mall/CA 01 under "Distributed I/Os / ET 200pro"

Selection and Ordering Data

Order No.

Digital electronics modules

Digital input modules

Digital input module 8 DI High Feature

24 V DC, with channel diagnostics, including bus module. Connection module must be ordered separately

6ES7 141-4BF00-0AB0 B)

Digital output modules

Digital output module 4 DO High Feature

24 V DC, 2 A, with channel diagnostics, including bus module. Connection module must be ordered separately

6ES7 142-4BD00-0AB0 B)

Accessories

Connection module CM IO 4 x M12

4 M12 sockets for connecting digital or analog sensors/actuators to ET 200pro

6ES7 194-4CA00-0AA0 B)

Connection module CM IO 8 x M12

8 M12 sockets for connecting digital sensors/actuators to ET 200pro

6ES7 194-4CB00-0AA0 B)

Module labels

for color-coded identification of the CM IOs in white, red, blue and green; pack with 100 units of each color

6ES7 194-4HA00-0AA0

Further accessories

For plugs, cables and further accessories, see Catalog IK PI or Mall/CA 01 under "Distributed I/O / ET 200pro"

B) Subject to export regulations: AL: N, ECCN: EAR99H

Accessories

Connection modules

Actuators and sensors are connected using commercially-available 5-contact M12 plugs on the connection module. The connection module is plugged onto the electronics module, and screwed to the latter. The following connection modules (to be ordered separately) are available for the above-mentioned electronics modules:

- CM IO 4x M12 (for EM DI and EM DO)
- CM IO 8x M12 (for EM DI)

Depending on the selected connection module, each plug for the 8-channel digital input module has one or two channels:

- 4 x M12 round plug connections with 2 channels per plug (double assignment)
- 8 x M12 round plug connections with 1 channel per plug (single assignment)

Overview



The following analog electronics modules can be used for connecting actuators/sensors in the context of SIMATIC PCS 7:

Analog input modules

EM 4 AI U High Feature

- 4 inputs for voltage measurements
- Input ranges:
 - ± 10 V, resolution 15 bit + sign
 - ± 5 V, resolution 15 bit + sign
 - 0 to 10 V, resolution 15 bit
 - 1 to 5 V, resolution 15 bit
- Electrically isolated from load voltage 2L+
- Diagnostics "Short-circuit of sensor supply to M" per module
- Diagnostics "Short-circuit, open-circuit" per channel (depending on measuring range)
- Process interrupt with limit violation on channel 0
- Permissible common-mode voltage 5 Vpp AC

EM 4 AI I High Feature

- 4 inputs for current measurements
- Input ranges:
 - ± 20 mA, resolution 15 bit + sign
 - 0 to 20 mA, resolution 15 bit
 - 4 to 20 mA, resolution 15 bit
- Two-wire and four-wire transmitters can be connected
- Electrically isolated from load voltage 2L+
- Diagnostics "Short-circuit of sensor supply to M" per module
- Diagnostics "Short-circuit, open-circuit" per channel (depending on measuring range)
- Process interrupt with limit violation on channel 0
- Permissible common-mode voltage 5 Vpp AC

EM 4 AI RTD High Feature

- 4 inputs for isolated (floating) resistance measurements or resistance thermometers with 2-, 3- and 4-wire connections
- Input ranges:
 - Resistance measurement: 150 Ω ; 300 Ω ; 600 Ω ; 3000 Ω ; resolution 15 bit
 - Resistance thermometer: Pt100; Ni100; Ni120; Pt200; Ni200; Pt500; Ni500; Pt1000; Ni1000; resolution 15 bit + sign
- Automatic compensation of line resistances with 3- and 4-wire connections
- Parameterizable temperature coefficient with resistance-type sensors
- Electrically isolated from load voltage supply 1L+ and 2L+
- Linearization of sensor characteristics
- Diagnostics "Open-circuit" per channel (terminals 1 and 3 are monitored for open-circuit)
- Permissible common-mode voltage 10 Vpp AC

Analog output modules

EM 4 AO U High Feature

- 4 outputs for voltage output
- Output ranges:
 - ± 10 V, resolution 15 bit + sign
 - 1 to 5 V, resolution 14 bit
 - 0 to 10 V, resolution 15 bit
- Electrically isolated from sensor supply voltage 1L+
- Diagnostics "Short-circuit of sensor supply to M" per module
- Diagnostics "Open-circuit in outputs" per channel
- Substitute value output

EM 4 AO I High Feature

- 4 outputs for current output
- Output ranges:
 - ± 20 mA, resolution 15 bit + sign
 - 4 to 20 mA, resolution 14 bit
 - 0 to 20 mA, resolution 15 bit
- Electrically isolated from sensor supply voltage 1L+
- Diagnostics "Short-circuit of sensor supply to M" per module
- Diagnostics "Open-circuit" per channel
- Substitute value output

Technical specifications

For detailed technical specifications of the analog electronics modules, see:

- Catalog IK PI
- Mall/CA 01 under "Distributed I/Os / ET 200pro"

Process I/O

Dezentrale Peripherie ET 200pro

Analog electronics modules EM 144, EM 145

Selection and Ordering Data

Order No.

Analog electronics modules

Analog input modules

Analog input module 4 AI U

High Feature, ± 10 V; ± 5 V; 0 to 10 V; 1 to 5 V, channel diagnostics, including bus module. Connection module must be ordered separately

6ES7 144-4FF00-0AB0 B)

Analog input module 4 AI I

High Feature, ± 20 mA; 0 to 20 mA; 4 to 20 mA, channel diagnostics, including bus module. Connection module must be ordered separately

6ES7 144-4GF00-0AB0 B)

Analog input module 4 AI RTD

High Feature; resistances: 150, 300, 600 and 3000 Ohm; resistance thermometers: Pt100, 200, 500, 1000, Ni100, 120, 200, 500 and 1000; channel diagnostics, including bus module. Connection module must be ordered separately

6ES7 144-4JF00-0AB0 B)

Analog output modules

Analog output module 4 AO U

High Feature, ± 10 V; 0 to 10 V; 1 to 5 V, channel diagnostics, including bus module. Connection module must be ordered separately

6ES7 145-4FF00-0AB0 B)

Analog output module 4 AO I

High Feature, ± 20 mA; 0 to 20 mA; 4 to 20 mA, channel diagnostics, including bus module. Connection module must be ordered separately

6ES7 145-4GF00-0AB0 B)

Accessories

Connection module CM IO 4 x M12

4 M12 sockets for connecting digital or analog sensors/actuators to ET 200pro

6ES7 194-4CA00-0AA0 B)

Module labels

for color-coded identification of the CM IOs in white, red, blue and green; pack with 100 units of each color

6ES7 194-4HA00-0AA0

Further accessories

For plugs, cables and further accessories, see Catalog IK PI or Mall/CA 01 under "Distributed I/O / ET 200pro"

Accessories

Connection modules

Actuators and sensors are connected using commercially-available 5-contact M12 plugs on the connection module. The connection module is plugged onto the electronics module, and screwed to the latter. The connection module CM IO 4 x M12 (to be ordered separately) is available for the above-mentioned electronics modules:

11

B) Subject to export regulations: AL: N, ECCN: EAR99H

Safety-related electronics modules

Overview



In combination with the safety-related automation systems of the SIMATIC PCS 7 process control system, the safety-related electronics modules of SIMATIC ET 200pro can be used to implement safety applications. The safety-related digital inputs record the signal statuses from safety-related sensors, and generate corresponding safety telegrams for the automation system. Depending on the safety telegrams of the automation system, the safety-related digital outputs trigger safe shut-down procedures. They are also responsible for monitoring short-circuits and cross-circuits up to the actuator. The safe communication with the automation systems is carried out over PROFIBUS with PROFIsafe.

All modules are certified up to SIL 3 (IEC 61508) and Cat. 4 (EN954-1).

The following modules are available:

Safety-related digital input module EM 8/16 F-DI PROFIsafe

- 16 inputs (SIL2/Cat.3) or 8 inputs (SIL3/Cat.3 or Cat.4)
- Suitable for standard switches and 3/4-wire proximity switches (BEROs)
- Rated input voltage 24 V DC
- 4 short-circuit-proof sensor supplies for 4 inputs each
- External sensor power supply possible
- Group fault display (SF; red LED)
- Fault display for each sensor power supply (Vs1F to Vs4F) is output on the VsF LED and the associated channels
- Status and fault displays per input (dual-color green/red LED)
- Identification data
- Parameterizable diagnostics
- Can only be operated in safety mode

Safety-related digital input/output module EM 4/8 F-DI, 4 F-DO 2 A

- Inputs
 - 8 inputs (SIL 2/Cat. 3) or 4 inputs (SIL 3/Cat. 3 or Cat. 4)
 - Suitable for standard switches and 3/4-wire proximity switches (BEROs)
 - Rated input voltage 24 V DC
 - 2 short-circuit-proof sensor supplies for 4 inputs each
 - External sensor power supply possible
- Outputs
 - 4 outputs, current sourcing/sinking
 - Output current 2 A
 - Rated load voltage 24 V DC
 - Suitable for solenoid valves, DC contactors and indicator lights

- Group fault display (SF; red LED)
- Fault display for each sensor power supply (Vs1F to Vs2F) is output on the VsF LED and the associated channels
- Status and fault displays per input/output (dual-color green/red LED)
- Identification data
- Parameterizable diagnostics
- Achievable safety class SIL 3
- Can only be operated in safety mode

Technical specifications

For detailed technical specifications of the safety-related electronics modules, see:

- Catalog IK PI
- Mall/CA 01 under "Distributed I/Os / ET 200pro"

Process I/O

Dezentrale Peripherie ET 200pro

Safety-related electronics modules

Selection and Ordering Data Order No.

Safety-related electronics modules

Safety-related digital input module

Safety-related digital input module 8/16 F-DI PROFIsafe

24 V DC, including bus module. Connection module must be ordered separately

6ES7 148-4FA00-0AB0 B)

Safety-related digital input/output module

Safety-related digital input/output module 4/8 F-DI, 4 F-DO 2 A

24 V DC, including bus module. Connection module must be ordered separately

6ES7 148-4FC00-0AB0 B)

Accessories

Connection module

- CM IO 16 x M12 for the electronics module 8/16 F-DI, 24 V DC/2 A
- CM IO 12 x M12 for the electronics module 4/8 F-DI/4 F DO, 24 V DC/2 A

6ES7 194-4DD00-0AA0 B)

6ES7 194-4DC00-0AA0 B)

Further accessories

For plugs, cables and further accessories, see Catalog IK PI or Mall/CA 01 under "Distributed I/O/ET 200pro"

B) Subject to export regulations: AL: N, ECCN: EAR99H

Accessories

Connection modules

Actuators and sensors are connected using commercially-available 5-contact M12 plugs on the connection module. The connection module is plugged onto the electronics module, and screwed to the latter. One of the following connection modules (to be ordered separately) is required for each of the above-mentioned electronics modules:

- Connection module CM IO 16 x M12 for the electronics module 8/16 F-DI, 24 V DC/2 A
- Connection module CM IO 12 x M12 for the electronics module 4/8 F-DI/4 F DO, 24 V DC/2 A

Overview



The power module PM-E DC 24 V is used within an ET 200pro station when generating 24 V DC load voltage groups for electronics modules.

You can position power modules in an ET 200pro station anywhere to the right of the interface module. The first power module is already integrated in the interface module.

Each power module which you install in the ET 200pro station interrupts the load voltage busbar, and opens up a new potential group (common potential) for the load voltage supply 2L+. All subsequent load voltages of the electronics modules are fed from this power module. Each power module has a replaceable fuse for protecting the device. Only line protection according to DIN VDE 0100 need be provided externally in addition.

The electronics/sensor supply 1L+ is not interrupted by the power module, it is looped through.

The power module is fitted on the associated bus module when delivered.

Technical specifications

For detailed technical specifications of the power module PM-E, see:

- Catalog IK PI
- Mall/CA 01 under "Distributed I/Os / ET 200pro"

Selection and Ordering Data

Order No.

Power module

Power module PM-E DC 24 V

For generating 24 V DC load voltage groups for electronics modules within an ET 200pro station.

6ES7148-4CA00-0AA0 B)

Accessories

Connection modules for power module

- Connection module CM PM-E ECOFAST for supply of 24 V DC load voltage, 1 ECOFAST Cu connection

6ES7 194-4BA00-0AA0 B)

- Connection module CM PM-E direct for supply of 24 V DC load voltage, up to two M20 cable glands

6ES7 194-4BC00-0AA0 B)

- Connection module CM PM-E 7/8" for supply of 24 V DC load voltage, 1 x 7/8"

6ES7 194-4BD00-0AA0 B)

Spare fuse

12.5 A fast-blow, for interface and power modules, 10 units per pack

6ES7 194-4HB00-0AA0

Further accessories

For plugs, cables and further accessories, see Catalog IK PI or Mall/CA 01 under "Distributed I/O / ET 200pro"

B) Subject to export regulations: AL: N, ECCN: EAR99H

Accessories

Connection module

The connection module for the power module PM-E is used to connect the load voltage 2L+. It is fitted on the power module.

The module must be ordered separately, and is available with the following types of connection:

- CM PM-E direct
- CM PM-E ECOFAST
- CM PM-E 7/8"

Process I/O



IT world



12/2

SIMATIC IT



SIMATIC IT

Overview



Integration and synchronization of all business processes with SIMATIC IT

In order to remain competitive, manufacturers must shorten their product launch times, increase production transparency and flexibility, optimize planning and scheduling, and reduce waste, storage costs and downtimes. At the same time, directives and high-quality standards must be observed in the global production locations, and maximum productivity and optimum costs must be guaranteed.

Manufacturing Execution System (MES), such as SIMATIC IT from Siemens, permit effective integration of product processes and material management systems, and support the coordination of all equipment and applications relevant to production during all phases.

SIMATIC IT can be used to model the complete production know-how, to precisely define the operating processes, and to record data in real-time from the ERP and production levels. It is then possible to control corporate processes more effectively, to minimize downtimes, production waste and postprocessing, to optimize stockkeeping, and to react rapidly and flexibly to changing customer requirements.

Design

SIMATIC IT consists of various components designed for different tasks which can all be coordinated by the SIMATIC IT Production Modeler.

The basic functions are implemented using SIMATIC IT components. These are available in the form of the following product bundles:

- **SIMATIC IT Plant Intelligence** (formally known as MIS - Management Information System)
Defines key performance indicators conforming to the plant model. SIMATIC IT Plant Intelligence allows realistic assessment of the plant performance.
- **SIMATIC IT Genealogy Management**
For materials management in the entire company, taking into account the legal terms and conditions. Typical tasks are reverse and forwards genealogy, fundamental material monitoring, and synchronization of material master data with the ERP system.
- **SIMATIC IT Order Management**
For job management from planning to execution, including scheduling, materials planning, new planning of sequence, monitoring and recording of execution.

Further bundles are available, e.g. SIMATIC IT Basic Tracking & Tracing, SIMATIC IT Basic Production Management or SIMATIC IT Production Suite, providing a fully-scaled product portfolio.

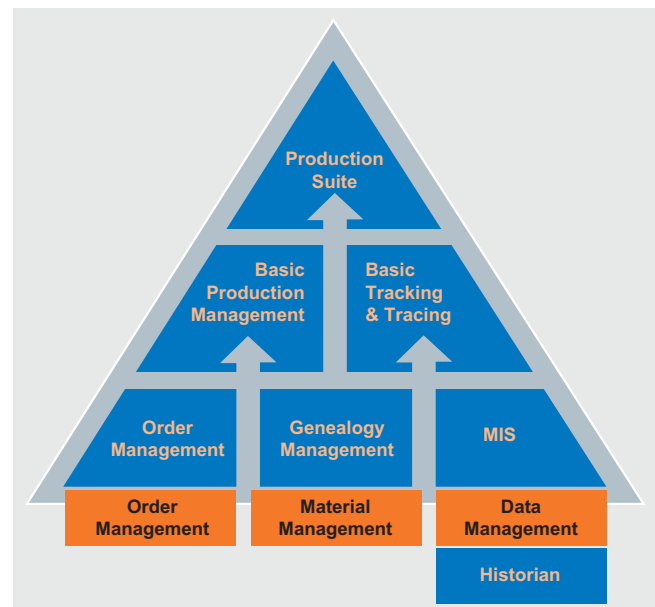

Summary of SIMATIC IT bundles

Each of these product bundles contains the optional SIMATIC IT Client Application Builder (CAB) which provides the GUI for the MES applications in a complete Web-based environment. Patented functions for optimization of image updating are available based on standard technology. The SIMATIC IT Client Application Builder offers complete support for operator stations which require practically no administrative overhead (so-called zero administration cost clients).

Additional options can be separately purchased for each bundle:

- **SIMATIC IT PDS-I (Predictive Detailed Scheduler - Interactive)** is the detailed scheduling component of SIMATIC IT. It coordinates and processes the job list coming from the ERP (Enterprise Resources Planning) or APS (Advanced Planning System) with consideration of all available resources in real-time. An advanced, dedicated interface even allows users who have no IT or scheduling experience to produce optimum production job planning. A number of predefined steps additionally support users in selection of the best planning scenario.
- **SIMATIC IT Report Manager** offers comprehensive reporting functions. It provides valuable knowledge concerning the company and supports users in complying with statutory requirements for ad hoc reporting (e.g. EU directive EC 178/2002 for Europe, US bioterrorism act for North America).
- **SIMATIC IT OEE-DTM Option (Overall Equipment Efficiency / Down Time Management)** offers support for the dedicated configuration for downtime management and efficient utilization of the overall equipment through various predefined KPIs for evaluation of performance and efficiency. It also allows customized performance calculations as well as real and consistent efficiency analysis using graphic objects. Thanks to integration within the complete SIMATIC IT infrastructure, it supports the implementation of corrective and/or preventive actions for avoiding reductions in quality.
- **SIMATIC IT SPC (Statistical Process Control)** is used for the dedicated configuration of statistical process control through various predefined KPIs for evaluation with the most common control charts (e.g. Nelson and Western Electric). It also allows customized KPI calculations as well as consistent statistical analyses with application of graphic objects. Thanks to integration within the complete SIMATIC IT infrastructure, it supports the implementation of corrective and/or preventive actions for avoiding reductions in quality.

The MES product range of SIMATIC IT is completed by the following components for special ISA-95 functions (also offered as stand-alone products):

- **SIMATIC IT Unilab**
Laboratory Information System / Laboratory Information Management System (LIMS) for management and control of laboratory data and processes.
- **SIMATIC IT Interspec**
Specifications Management System for support of product lifecycle / Product Lifecycle Management (PLM) for management and control of production specifications in the entire company.
- **SIMATIC IT XHQ**
provides decision-makers in a company with a tool for making better, faster and more sound decisions at all levels through the assistance of role-based Web views, thus increasing the company's total performance. This allows manufacturers to positively influence the production result through early and qualified decisions concerning the production sequence. As a result of the complete overview of all critical business and operating data from various sources within the company, operators and managers are able to check the true performance compared to corporate targets. SIMATIC IT XHQ is initially focused on the chemical and oil & gas industries.

Function

SIMATIC IT from Siemens offers significant advantages. The model of the business and production processes is transparent, understandable, and independent of the control systems. Even complex business and production processes are easy to model. Subsequent modifications can be incorporated efficiently and without problem.

Modeling of the business and production processes with SIMATIC IT allows complete documentation as well as effective protection of know-how.

The plant and production models can be saved in libraries, and then used again in other projects. In this manner, they can be used at any company location for standardization of procedures. Best practices are therefore available everywhere. This prevents implementation errors, provides investment safeguarding, reduces launch and maintenance costs, and results in a significant shortening in the project duration.

The product architecture and functionality of SIMATIC IT are in conformance with ISA-95, the internationally recognized standard for Manufacturing Execution Systems and Manufacturing Operation Management.

Integration

Integration of SIMATIC IT and SIMATIC PCS 7

The **Product Integration Pack** is available for joint projects with SIMATIC IT und SIMATIC PCS 7, and includes two data media (one each for the two target systems SIMATIC IT and SIMATIC PCS 7). These contain the software updates required for integrated configurations.

A user manual is also enclosed which provides information and important notes for persons planning, developing and implementing integration projects.

The integration pack can be obtained using the SIMATIC IT purchasing methods.

More information

Contact partners

Marketing Germany
Andreas Kempenich
E-mail: andreas.kempenich@siemens.com
Europe Helpline: +49 (0) 180 5050 111

Siemens Automation and Drives
Automation Solutions MES
Viale Cembrano, 11
I-16148 Genua, Italy
Tel.: +39 010 3434-1
Fax: +39 010 383 115
E-mail: marketing.simatic-it@siemens.com

Additional information is available in the Internet under:



<http://www.siemens.com/simatic-it>

IT world



Migration to SIMATIC PCS 7



13/2 Introduction



Migration to SIMATIC PCS 7

Introduction

Overview

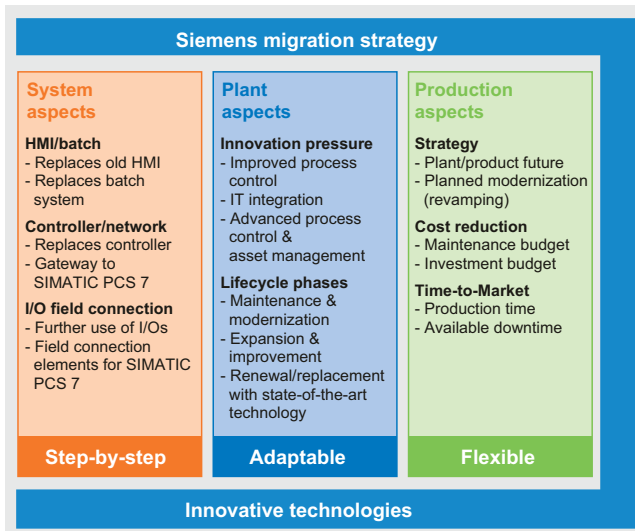

Migration strategy

Globalization and incessantly increasing competitive pressures are forcing companies to continuously increase productivity and shorten product time to market. To this end, it is necessary to continuously optimize engineering procedures and the process, and to simultaneously consider new industrial requirements and directives.

Today, many systems and plants must be expanded and modernized to ensure that companies can continue to provide products meeting market requirements. However, since the installed basis of hardware, application software and know-how of the operating and maintenance engineers represents an enormous value, the safeguarding of investments for companies operating the plants is always assigned a high priority during all modernization plans.

Experience has shown that the success of migration is largely determined by providing a technical solution that optimally matches the customer requirements and the customer's plant. Minimization of the technical and financial risks together with safeguarding of investments for as long a period as possible are always fundamental aspects. The different lifecycles of the various system components must also be considered, which currently vary from 5 years for PC-based workstations, 15 years for controllers, up to 25 years or more for input/output components and wiring. Therefore Siemens does not consider its task to simply be the complete replacement of an existing system, but in close collaboration together with customers and their system integrators of an individual, future-oriented solution based on the state-of-the-art SIMATIC PCS 7 process control system - always under the directives:

- **Step-by-step** system innovation
- **Adaptable** to the specific conditions of the plant
- **Flexible** according to production requirements

Function

Portfolio of the migration products

Early on Siemens recognized the significance of migration for process automation, and for many years has offered a wide range of innovative migration products and solutions for its globally proven systems. Right from the beginning, the maxim of Siemens' migration strategy is to modernize the existing installed basis in steps without completely changing the system; and where possible without or with minimal plant downtime. Siemens has the products to support customers' endeavors to achieve long-term safeguarding of investments together with maximization of their return on assets, even for legacy systems from other vendors.

Siemens' know-how in the migration sector has continuously grown as time has passed. The experience gained in numerous migration projects has been incorporated into new products and technologies which are even more efficient. For example, "Database Automation" (DBA) is available for engineering of operation and monitoring systems. Using DBA and a plug-in interface, it is possible to download the configuration data, and to display and configure them using a standardized user interface. DBA allows system-based migration of operator system data from different output systems in standardized form, thus providing uniform software quality, security and understandability.

The migration products can be categorized as follows:

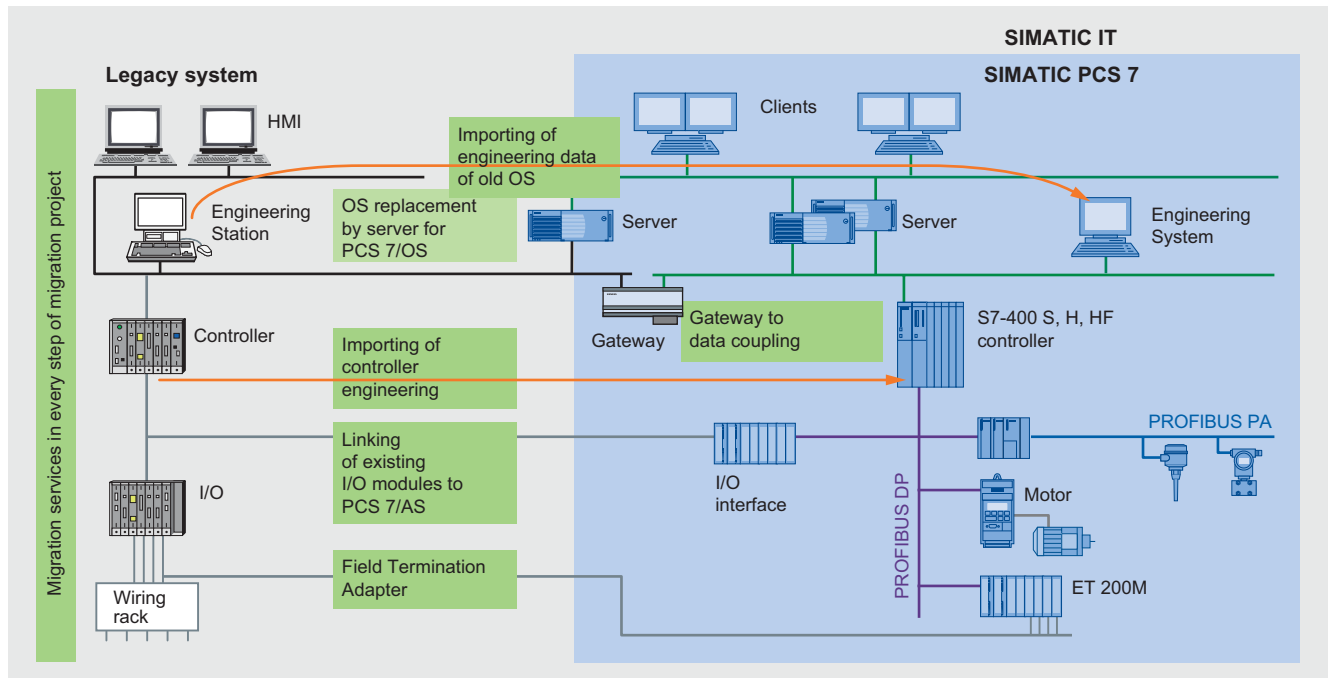

Step-by-step migration with the right products and services

Migration component	Description
OS migration products	<ul style="list-style-type: none"> Interface from SIMATIC PCS 7 OS Server to system bus of legacy system OS conversion tool (e.g. DBA) Faceplate library
Services for OS migration	Tools/services for conversion of process displays
Services for AS migration	Tools/services for function-based conversion of AS engineering data to SIMATIC PCS 7
BATCH migration components	Enables existing system to use SIMATIC BATCH
Gateway	<ul style="list-style-type: none"> Gateway between system bus of legacy system and SIMATIC PCS 7 (mainly for AS-AS communication) Engineering tool for gateway
Reuse of legacy system I/Os or Field Termination Assembly (FTA)	<ul style="list-style-type: none"> Reuse of I/Os (connection of old I/Os to SIMATIC PCS 7 automation systems, mostly for Siemens systems) Field Termination Assemblies (FTAs) for field cabling

Migration to SIMATIC PCS 7

Introduction

Typical migration scenarios

The migration path that a user takes depends on the specific technical and economical factors of each migration project. The migration products offer the modularity and flexibility required to implement different scenarios. The following are typical migration scenarios which can be implemented using these migration products:

Scenario 1: Replacement of existing HMI system by a SIMATIC PCS 7 operator system

If the HMI (Human Machine Interface) system is technically obsolete, if the stocking of spare parts is too expensive, if it no longer complies with current directives and standards for operator workstations, or if functional expansions are required (e.g. IT integration), it is possible to simply replace the existing HMI system by a SIMATIC PCS 7 operator system. The controller with application software and the process I/O are retained.

The benefits of these migration step are:

- Minimum costs
- Clear risk
- Lengthening of service life of complete plant
- New application possibilities
- Opening of system for IT world

Scenario 2: Expansion of existing plant

The existing plant is initially retained, and is modernized by expanding with further sections/units with SIMATIC PCS 7.

The benefits of these migration step are:

- Simple, step-by-step increase in production capacity
- Clear risk
- Introduction of new technologies (e.g. PROFIBUS fieldbus, HMI)
- Opening of system for IT world
- Together with scenario 1, enables process control using a uniform operator system

Scenario 3: Comprehensive modernization

Bottlenecks in the provision of spare parts, insufficient support, and the necessity for functional expansions (e.g. fieldbus technology or IT integration) can also force comprehensive modernization of the old system using the future-oriented SIMATIC PCS 7 process control system. Conversion may also be possible during operation. Further use of the existing I/O level is supported, and the investments made for wiring, hardware components or application engineering are safeguarded.

The benefits of these migration step are:

- Increase in performance
- Introduction of new technologies (e.g. PROFIBUS fieldbus, HMI)
- Opening of system for IT world
- Lengthening of service life of complete plant
- Reduction in number of system suppliers
- Elimination of bottlenecks

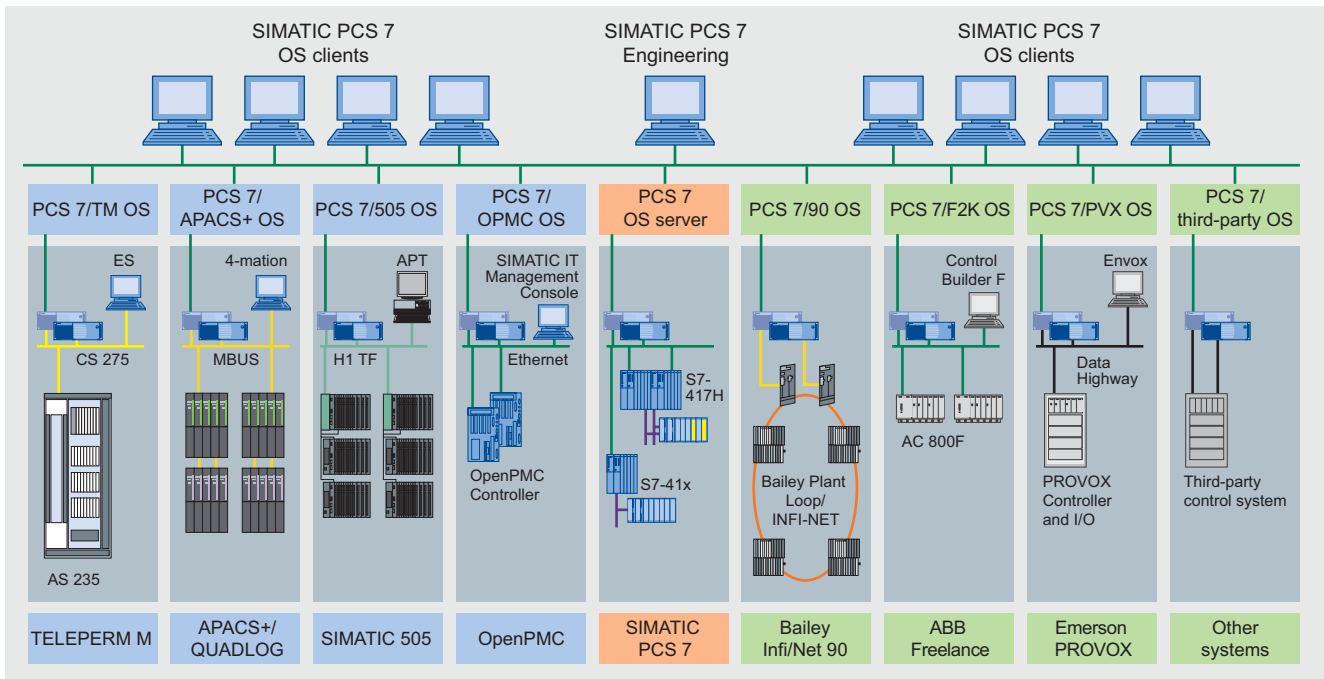

Migration spectrum

The migration of our own process control systems to SIMATIC PCS 7 is a matter of course for Siemens, and a significant component of the continued supplier/customer relationship. Siemens is additionally able to offer migration solutions for process control systems from other vendors, e.g. for systems from ABB, Honeywell or Emerson.

Siemens can work closely with the customer's system integrators when implementing migration projects, for they have the know-how gained over many years of working with the user and exactly know the plant as well as the customer's requirements. This partnership is a guarantee for the companies operating plants that they will receive an optimum migration solution. A further important aspect is that Siemens supports the migration products as well as the standard products by means of product updating and customer support. A special strength of Siemens compared to other suppliers of migration solutions is the ability to offer customers long-term support through know-how, servicing and provision of components, spare parts and upgrades.

With the future-oriented SIMATIC PCS 7 process control system, innovative migration solutions and services, many years of know-how in process automation and migration, as well as continuous worldwide servicing, Siemens demonstrates its expertise and offers the security of a reliable partner.

Migration Support Center

Siemens has established several global Migration Support Centers which offer customers further support for migration projects in addition to product support:

- Migration concepts
- Quotation preparation
- Engineering/project management

Development of further migration products and tools

Through the development of flexible migration solutions and services, comprehensive sector know-how, migration experience developed over many years, and worldwide support, Siemens has laid the foundation for the development of migration solutions for third-party control systems. This allows users of third-party control systems to take advantage of the globally leading SIMATIC technology in order to safeguard their investments in new automation technology for the future.

More information

For further information, see the Chapter "Additional migration products and solutions".

Migration to SIMATIC PCS 7



Ordering data for previous version SIMATIC PCS 7 V6.1

14

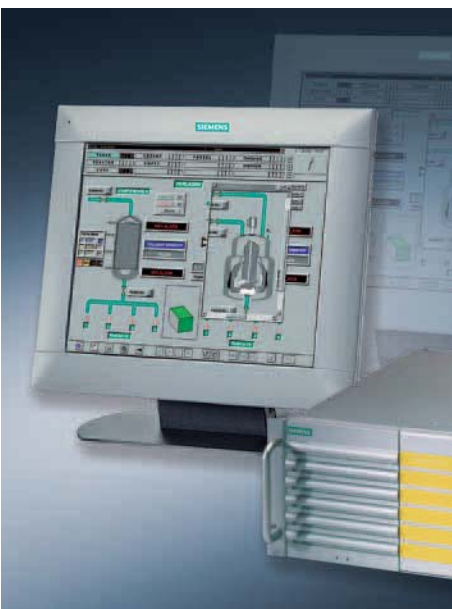

14/2	Basic hardware V6.1
14/4	Starter systems V6.1
14/5	ES software V6.1
14/9	OS software V6.1
14/13	SIMATIC BATCH Software V6.1
14/14	Route Control Software V6.1
14/15	Asset Management Software V6.1
14/16	PROFIBUS PA components
14/17	Automation systems



Ordering data for previous version SIMATIC PCS 7 V6.1

Basic hardware V6.1

Selection and Ordering Data

Order No.

Single station

SIMATIC PC in rack of 19" design, Pentium 4 3.4 GHz, 1 GB RAM (2 x 512 MB), sound, SATA-RAID 1 with 2 hard disks of 120 GB, graphics controller on board with dynamic video memory, DVD writer DVD±RW IDE, 3.5" diskette drive, optical mouse,

FastEthernet RJ45 on board for connection to OS-LAN,

without monitor, keyboard and printer,

SIMATIC PCS 7 software pre-installed and 2 restore DVDs

Windows 2000 Professional MUI operating system

(German, English, French, Italian, Spanish, Chinese, Japanese)

• **SIMATIC PCS 7 ES/OS IL43 BCE W2K** 6ES7 650-0LC16-0YX0 D)

Connection to plant bus through Basic Communication Ethernet (BCE) with FastEthernet RJ45 network card (PCI card)

• **SIMATIC PCS 7 ES/OS IL43 IE W2K** 6ES7 650-0LC16-0YX1 D)

Connection to plant bus via Industrial Ethernet with CP 1613 A2 communications processor

Windows XP Professional MUI operating system

(German, English, French, Italian, Spanish, Chinese, Japanese)

• **SIMATIC PCS 7 ES/OS IL43 BCE WXP** 6ES7 650-0LF16-0YX0 D)

Connection to plant bus through Basic Communication Ethernet (BCE) with FastEthernet RJ45 network card (PCI card)

• **SIMATIC PCS 7 ES/OS IL43 IE WXP** 6ES7 650-0LF16-0YX1 D)

Connection to plant bus via Industrial Ethernet with CP 1613 A2 communications processor

Selection and Ordering Data

Order No.

Server

SIMATIC PC in rack of 19" design, Pentium 4 3.4 GHz, 1 GB RAM (2 x 512 MB), sound, SATA-RAID 1 with 2 hard disks of 120 GB, graphics controller on board with dynamic video memory, DVD-ROM IDE, 3.5" diskette drive, optical mouse,

FastEthernet RJ45 on board for connection to OS-LAN,

without monitor, keyboard and printer,

SIMATIC PCS 7 software pre-installed and 2 restore DVDs

Windows 2000 Server MUI operating system

(German, English, French, Italian, Spanish, Chinese, Japanese)

• **SIMATIC PCS 7 OS Server IL43 BCE W2K** 6ES7 650-0LE16-0YX0 D)

Connection to plant bus through Basic Communication Ethernet (BCE) with FastEthernet RJ45 network card (PCI card)

• **SIMATIC PCS 7 OS Server IL43 IE W2K** 6ES7 650-0LE16-0YX1 D)

Connection to plant bus via Industrial Ethernet with CP 1613 A2 communications processor

Windows Server 2003 MUI operating system

(German, English, French, Italian, Spanish, Chinese, Japanese)

• **SIMATIC PCS 7 OS Server IL43 BCE SRV03** 6ES7 650-0LH16-0YX0 D)

Connection to plant bus through Basic Communication Ethernet (BCE) with FastEthernet RJ45 network card (PCI card)

• **SIMATIC PCS 7 OS Server IL43 IE SRV03** 6ES7 650-0LH16-0YX1 D)

Connection to plant bus via Industrial Ethernet with CP 1613 A2 communications processor

D) Subject to export regulations: AL: N, ECCN: 5D992B1

Ordering data for previous version SIMATIC PCS 7 V6.1

Basic hardware V6.1

Selection and Ordering Data	Order No.	Selection and Ordering Data	Order No.
Client SIMATIC PC in rack of 19" design, Pentium 4 3.4 GHz, 512 MB RAM (2 x 256 MB), SATA hard disk 120 GB, graphics controller on board with dynamic video memory, DVD-ROM IDE, 3.5" diskette drive, optical mouse, FastEthernet RJ45 on board for connection to OS-LAN, without monitor, keyboard and printer, SIMATIC PCS 7 preinstalled and 2 restore DVDs <u>Windows 2000 Professional MUI operating system</u> (German, English, French, Italian, Spanish, Chinese, Japanese) • SIMATIC PCS 7 OS Client IL43 W2K			
	6ES7 650-0LD16-0YX0 D)	Additional and expansion components Memory modules for expanding the main memory <ul style="list-style-type: none"> • 512 MB memory expansion kit for SIMATIC Rack PC IL 43 (2 x 256 MB) for dual channel 6ES7 648-2AF30-0GB0 B) • 1 GB memory expansion kit for SIMATIC Rack PC IL 43 (2 x 512 MB) for dual channel 6ES7 648-2AF40-0GB0 B) • 2 GB memory expansion kit for SIMATIC Rack PC IL 43 (2 x 1 GB) for dual channel 6ES7 648-2AF50-0GB0 B) 	
		SIMATIC PC keyboard (USB connection) <ul style="list-style-type: none"> • International key assignment 6ES7 648-0CB00-0YA0 	
		Tower kit for SIMATIC PCS 7 Industrial Workstations based on Rack PC 547B and IL 43 <ul style="list-style-type: none"> • Tower kit for conversion of a Rack PC into an industrial Tower PC 6ES7 648-1AA00-0XC0 	
	6ES7 650-0LG16-0YX0 D)	3-m power cable for Rack PC ¹⁾ <ul style="list-style-type: none"> • For Great Britain 6ES7 900-0BA00-0XA0 • For Switzerland 6ES7 900-0CA00-0XA0 • For USA 6ES7 900-0DA00-0XA0 • For Italy 6ES7 900-0EA00-0XA0 	

B) Subject to export regulations: AL: N, ECCN: EAR99H

D) Subject to export regulations: AL: N, ECCN: 5D992B1

¹⁾ The PCS 7 systems are delivered as standard with a "European power cable". The country-specific versions listed above are required for some countries.

Ordering data for previous version SIMATIC PCS 7 V6.1

Starter systems V6.1

SIMATIC PCS 7 BOX

Selection and Ordering Data	Order No.
<p>SIMATIC PCS 7 BOX complete system (ES, OS and AS) assembled and preinstalled, comprising:</p> <ul style="list-style-type: none"> • SIMATIC Box PC 627, 24 V DC, with WinAC Slot 416 and Windows XP Professional MUI (German, English, French, Italian, Spanish) • Memory card 2 MB • Backup battery • Mouse • SIMATIC PCS 7 Engineering Software V6.1 for AS/OS, 250 POs/RC 8K, 3 languages (German, English, French), floating license for 1 user • PCS 7 Library Blocks V6.1, 3 languages (German, English, French), runtime license for 1 automation system 	6ES7 650-2MA16-0YX0 D)
<p>SIMATIC PCS 7 BOX runtime system (OS and AS) assembled and preinstalled, comprising:</p> <ul style="list-style-type: none"> • SIMATIC Box PC 627, 24 V DC, with WinAC Slot 416 and Windows XP Professional MUI (German, English, French, Italian, Spanish) • Memory card 2 MB • Backup battery • Mouse • SIMATIC PCS 7 OS Software Single Station V6.1, 250 POs/RT 8 K, 3 languages (German, English, French), single license for 1 installation • PCS 7 Library Blocks V6.1, 3 languages (German, English, French), runtime license for 1 automation system 	6ES7 650-2MB16-0YX0 D)

PCS 7 Basic Package

Selection and Ordering Data	Order No.
<p>PCS 7 Basic Package V6.1 comprising:</p> <ul style="list-style-type: none"> • 1 x AS 416-3 with <ul style="list-style-type: none"> - PS 407 power supply; 10 A for 120/230 V AC/DC - UR2 rack (9 slots) - Memory card 8 MB - CP 443-1EX11 - CP443-5 Extended • 1 x engineering station with <ul style="list-style-type: none"> - Basic device SIMATIC PCS 7 ES/OS IL 43 BCE WXP - PCS 7 engineering software for AS/OS; 1000 POs/RC 32K, floating license - SFC Visualization, floating license - PCS 7 Import/Export Assistant, floating license - SIMATIC PDM PCS 7, floating license • 1 x OS Single Station <ul style="list-style-type: none"> - Basic device SIMATIC PCS 7 ES/OS IL 43 BCE WXP - PCS 7 OS Software Single Station for 1000 POs/RT 32K, single license - SFC Visualization, floating license 	6ES7 650-3GD16-0YX0 D)

D) Subject to export regulations: AL: N, ECCN: 5D992B1

Ordering data for previous version SIMATIC PCS 7 V6.1

ES software V6.1

Standard engineering software

Selection and Ordering Data	Order No.
SIMATIC PCS 7 Engineering Software V6.1 3 languages (German, English, French), executes with Windows 2000 Professional/ 2000 Server or Windows XP Professional/ Server 2003, floating license for 1 user Electronic documentation on PCS 7 toolset DVD Type of delivery: License key disk, emergency key disk, certificate of license, terms and conditions; PCS 7 V6.1 toolset DVD, Microsoft SQL Server including EULA, PC Anywhere Host and supplementary CDs/DVDs (e.g. Microsoft ServicePacks and tools)	
<u>Engineering software for AS</u> <ul style="list-style-type: none"> • 250 POs (process objects) • 1000 POs • 2000 POs • 3000 POs • 5000 POs • Unlimited POs 	6ES7 658-1AA16-0YA5 6ES7 658-1AB16-0YA5 6ES7 658-1AC16-0YA5 6ES7 658-1AD16-0YA5 6ES7 658-1AE16-0YA5 6ES7 658-1AF16-0YA5
<u>Engineering software for OS</u> <ul style="list-style-type: none"> • 250 POs/RC 8K • 1000 POs/RC 32K • 2000 POs/RC 64K • 3000 POs/RC 100K • 5000 POs/RC 150K • 8500 POs/RC 256K 	6ES7 658-2DA16-0YA5 6ES7 658-2DB16-0YA5 6ES7 658-2DC16-0YA5 6ES7 658-2DD16-0YA5 6ES7 658-2DE16-0YA5 6ES7 658-2DF16-0YA5
<u>Engineering software for AS/OS</u> <ul style="list-style-type: none"> • 250 POs/RC 8K • 1000 POs/RC 32K • 2000 POs/RC 64K • 3000 POs/RC 100K • 5000 POs/RC 150K • Unlimited POs/RC 256K 	6ES7 658-5AA16-0YA5 6ES7 658-5AB16-0YA5 6ES7 658-5AC16-0YA5 6ES7 658-5AD16-0YA5 6ES7 658-5AE16-0YA5 6ES7 658-5AF16-0YA5
SIMATIC PCS 7 Engineering Software V6.1 Rental License 3 languages (German, English, French), executes with Windows 2000 Professional/ 2000 Server or Windows XP Professional/ Server 2003 Rental license for 50 hours Type of delivery: License key disk, emergency key disk, certificate of license, terms and conditions; PCS 7 V6.1 toolset DVD, Microsoft SQL Server including EULA, PC Anywhere Host and supplementary CDs/DVDs (e.g. Microsoft ServicePacks and tools)	
<ul style="list-style-type: none"> • For AS, 2000 POs • For OS, 2000 POs/RC 64K 	6ES7 658-1AC16-0YA6 6ES7 658-2DC16-0YA6

Selection and Ordering Data	Order No.
SIMATIC PCS 7 PowerPacks for engineering software SIMATIC PCS 7 PowerPack Engineering Software AS for extending the engineering software for AS 3 languages (German, English, French), executes with Windows 2000 Professional/ 2000 Server or Windows XP Professional/ Server 2003, floating license for 1 user Type of delivery: License key disk, emergency key disk, certificate of license, terms and conditions	
<ul style="list-style-type: none"> • From 250 POs to 1000 POs • From 1000 POs to 2000 POs • From 2000 POs to 3000 POs • From 3000 POs to 5000 POs • From 5000 POs to unlimited POs 	6ES7 658-1AB16-0YD5 6ES7 658-1AC16-0YD5 6ES7 658-1AD16-0YD5 6ES7 658-1AE16-0YD5 6ES7 658-1AF16-0YD5
SIMATIC PCS 7 PowerPack Engineering Software OS for extending the engineering software for OS 3 languages (German, English, French), executes with Windows 2000 Professional/ 2000 Server or Windows XP Professional/ Server 2003, floating license for 1 user Type of delivery: License key disk, emergency key disk, certificate of license, terms and conditions	
<ul style="list-style-type: none"> • From 250 POs/RC 8K to 1000 POs/RC 32K • From 1000 POs/RC 32K to 2000 POs/RC 64K • From 2000 POs/RC 64K to 3000 POs/RC 100K • From 3000 POs/RC 100K to 5000 POs/RC 150K • From 5000 POs/RC 150K to 8500 POs/RC 256K 	6ES7 658-2DB16-0YD5 6ES7 658-2DC16-0YD5 6ES7 658-2DD16-0YD5 6ES7 658-2DE16-0YD5 6ES7 658-2DF16-0YD5
SIMATIC PCS 7 PowerPack Engineering Software AS/OS for extending the engineering software for AS/OS 3 languages (German, English, French), executes with Windows 2000 Professional/ 2000 Server or Windows XP Professional/ Server 2003, floating license for 1 user Type of delivery: License key disk, emergency key disk, certificate of license, terms and conditions	
<ul style="list-style-type: none"> • From 250 POs/RC 8K to 1000 POs/RC 32K • From 1000 POs/RC 32K to 2000 POs/RC 64K • From 2000 POs/RC 64K to 3000 POs/RC 100K • From 3000 POs/RC 100K to 5000 POs/RC 150K • From 5000 POs/RC 150K to unlimited POs/RC 256K 	6ES7 658-5AB16-0YD5 6ES7 658-5AC16-0YD5 6ES7 658-5AD16-0YD5 6ES7 658-5AE16-0YD5 6ES7 658-5AF16-0YD5

Ordering data for previous version SIMATIC PCS 7 V6.1

ES software V6.1

Version Cross Checker

Selection and Ordering Data	Order No.
SIMATIC Version Cross Checker V6.1 3 languages (German, English, French), executes with Windows 2000 Professional or Windows XP Professional, floating license for 1 user Type of delivery: License key disk, emergency key disk, certificate of license, terms and conditions	6ES7 658-1CX16-2YB5

Version Trail

Selection and Ordering Data	Order No.
SIMATIC Version Trail V6.1 5 languages (German, English, French, Spanish, Italian), executes with Windows 2000 Professional, Windows XP Professional or Windows Server 2003, floating license for 1 user Type of delivery: License key disk, emergency key disk, certificate of license, terms and conditions	6ES7 658-1FX16-2YB5

Import/Export Assistant

Selection and Ordering Data	Order No.
SIMATIC PCS 7 Import/Export Assistant V6.1 3 languages (German, English, French), executes with Windows 2000 Professional/ 2000 Server or Windows XP Professional/ Server 2003, floating license for 1 user Type of delivery: License key disk, emergency key disk, certificate of license, terms and conditions	6ES7 658-1DX16-2YB5

Route Control Engineering

Selection and Ordering Data	Order No.
SIMATIC Route Control Engineering V6.1 3 languages (German, English, French), executes with Windows 2000 Professional/ 2000 Server or Windows XP Professional/ Server 2003 Type of delivery: License key disk, emergency key disk, certificate of license, terms and conditions • Floating license for 1 user	6ES7 658-7DX16-0YB5

Engineering F/FH Systems

Selection and Ordering Data	Order No.
S7 F Systems V6.0 Programming and configuration environment for creating and using safety-related STEP 7 programs for a target system based on S7-400H 2 languages (German, English), executes with Windows XP Professional SP2, Windows Server 2003 SP1/SP2 and Windows 2000 SP4, floating license for 1 user Type of delivery: Certificate of license as well as software and electronic documentation on CD	6ES7 833-1CC01-0YA5

Selection and Ordering Data	Order No.
S7 F Systems Upgrade from V5.x to V6.0 2 languages (German, English), executes with Windows XP Professional SP2, Windows Server 2003 SP1/SP2 and Windows 2000 SP4, floating license for 1 user Type of delivery: Certificate of license as well as software and electronic documentation on CD	6ES7 833-1CC01-0YE5

Note:

With a S7 F Systems Upgrade from V5.x to V6.0, the type of S7 F Systems license changes from single license to floating license.

Safety Matrix

Selection and Ordering Data	Order No.
SIMATIC Safety Matrix Tool Creation, configuration, compilation, loading and online monitoring of the Safety Matrix in a SIMATIC PCS 7 environment Including SIMATIC Safety Matrix Viewer for SIMATIC PCS 7, for operation and monitoring of the Safety Matrix in a SIMATIC PCS 7 environment with several operator control levels 2 languages (German, English), executes with Windows 2000 Professional, Windows XP Professional or Windows 2003 Server, single license for 1 installation Type of delivery: Certificate of license and authorization diskette for Safety Matrix Tool and Safety Matrix Viewer; software and electronic documentation on CD	6ES7 833-1SM00-0YA5 C)

Selection and Ordering Data	Order No.
SIMATIC Safety Matrix Editor Creation and checking of the Safety Matrix logic on an external computer without a SIMATIC PCS 7/ STEP 7 environment 2 languages (German, English), executes with Windows 2000 Professional, Windows XP Professional or Windows 2003 Server, single license for 1 installation Type of delivery: Certificate of license and authorization diskette; software and electronic documentation on CD	6ES7 833-1SM40-0YA5 C)

C) Subject to export regulations: AL: N, ECCN: EAR99S

SIMATIC PDM

Selection and Ordering Data	Order No.	Selection and Ordering Data	Order No.
SIMATIC PDM Single Point SIMATIC PDM Single Point V6.0 for operation and parameterization of one field device; communication via PROFIBUS DP/PA or HART modem, including 1 TAG, cannot be expanded with respect to functions or with TAG option/PowerPack 5 languages (German, English, French, Spanish, Italian), executes with Windows 2000 Professional or Windows XP Professional Floating license for 1 user Type of delivery: License key disk, emergency key disk, certificate of license, terms and conditions; 2 CDs with SIMATIC PDM V6.0 and device library as well as supplementary DVD with Microsoft ServicePacks and tools		Routing through S7-400 5 languages (German, English, French, Spanish, Italian), executes with Windows 2000 Professional or Windows XP Professional Type of delivery: License key disk, emergency key disk, certificate of license, terms and conditions • Floating license for 1 user	
	6ES7 658-3HX06-0YA5		6ES7 658-3CX06-2YB5
SIMATIC PDM Basic SIMATIC PDM Basic V6.0 for operation and parameterization of field devices and components, communication via PROFIBUS DP/PA, HART modem/interface, RS 232, Modbus, SIREC bus, SIFART DR, including 4 TAGs 5 languages (German, English, French, Spanish, Italian), executes with Windows 2000 Professional or Windows XP Professional Type of delivery: License key disk, emergency key disk, certificate of license, terms and conditions; 2 CDs with SIMATIC PDM V6.0 and device library as well as supplementary DVD with Microsoft ServicePacks and tools • Floating license for 1 user • Rental license for 50 hours		Communication via standard HART multiplexer 5 languages (German, English, French, Spanish, Italian), executes with Windows 2000 Professional or Windows XP Professional Type of delivery: License key disk, emergency key disk, certificate of license, terms and conditions • Floating license for 1 user	
			6ES7 658-3EX06-2YB5
Functional options for SIMATIC PDM V6.0 Integration in STEP 7 / SIMATIC PCS 7 Only required if integration of SIMATIC PDM into HW-Config is to be used 5 languages (German, English, French, Spanish, Italian), executes with Windows 2000 Professional or Windows XP Professional Type of delivery: License key disk, emergency key disk, certificate of license, terms and conditions • Floating license for 1 user		TAG options / PowerPacks SIMATIC PDM TAG option for TAG expansion, additive to SIMATIC PDM Basic V6.0 5 languages (German, English, French, Spanish, Italian), executes with Windows 2000 Professional or Windows XP Professional Floating license for 1 user Type of delivery: License key disk, certificate of license, terms and conditions • Up to 128 TAGs • Up to 512 TAGs • Up to 1024 TAGs • Up to 2048 TAGs SIMATIC PDM PowerPack for subsequent TAG expansion of all SIMATIC PDM V6.0 product configurations 5 languages (German, English, French, Spanish, Italian), executes with Windows 2000 Professional or Windows XP Professional Floating license for 1 user Type of delivery: License key disk, certificate of license, terms and conditions • From 128 TAGs to 512 TAGs • From 512 TAGs to 1024 TAGs • From 1024 TAGs to 2048 TAGs • From 2048 TAGs to unlimited TAGs	
	6ES7 658-3AX06-0YA5 6ES7 658-3AX06-0YA6		6ES7 658-3XA06-2YB5 6ES7 658-3XB06-2YB5 6ES7 658-3XC06-2YB5 6ES7 658-3XD06-2YB5 6ES7 658-3XB06-2YD5 6ES7 658-3XC06-2YD5 6ES7 658-3XD06-2YD5 6ES7 658-3XH06-2YD5
	6ES7 658-3BX06-2YB5		

Ordering data for previous version SIMATIC PCS 7 V6.1

ES software V6.1

Selection and Ordering Data Order No.

Predefined SIMATIC PDM V6.0 product configurations for special applications

SIMATIC PDM Service V6.0

Complete package for stand-alone users for servicing, with

- SIMATIC PDM Basic V6.0
- Option "128 TAGs"

5 languages (German, English, French, Spanish, Italian), executes with Windows 2000 Professional or Windows XP Professional, floating license for 1 user

Type of delivery:
License key disk, emergency key disk, certificate of license, terms and conditions;
2 CDs with SIMATIC PDM V6.0 and device library as well as supplementary DVD with Microsoft ServicePacks and tools

6ES7 658-3JX06-0YA5

SIMATIC PDM S7 V6.0

Complete package for use in a SIMATIC S7 configuration environment, with

- SIMATIC PDM Basic V6.0
- Option "Integration in STEP 7/PCS 7"
- Option "128 TAGs"

5 languages (German, English, French, Spanish, Italian), executes with Windows 2000 Professional or Windows XP Professional, floating license for 1 user

Type of delivery:
License key disk, emergency key disk, certificate of license, terms and conditions;
2 CDs with SIMATIC PDM V6.0 and device library as well as supplementary DVD with Microsoft ServicePacks and tools

6ES7 658-3KX06-0YA5

SIMATIC PDM PCS 7 V6.0

Complete package for integration into the engineering toolset of the SIMATIC PCS 7 engineering system

Floating license for 1 user, with

- SIMATIC PDM Basic
- Option "Integration in STEP 7/PCS 7"
- Option "Routing through S7-400"
- Option "128 TAGs"

5 languages (German, English, French, Spanish, Italian), executes with Windows 2000 Professional or Windows XP Professional

Type of delivery:
License key disk, emergency key disk, certificate of license, terms and conditions;
2 CDs with SIMATIC PDM V6.0 and device library as well as supplementary DVD with Microsoft ServicePacks and tools

6ES7 658-3LX06-0YA5

Controller optimization

Selection and Ordering Data Order No.

SIMATIC PCS 7 PID Tuner V6.1

Controller optimization; option package for CFC

3 languages (German, English, French), executes with Windows 2000 Professional/ 2000 Server or Windows XP Professional/ Server 2003

Floating license for 1 user

Type of delivery:
License key disk, emergency key disk, certificate of license, terms and conditions

6ES7 653-OSP16-2YB5

Simulation with S7-PLCSIM

Selection and Ordering Data Order No.

S7-PLCSIM V5.3

Functional testing of programs which were created with CFC/SFC, on PC/PG

5 languages (German, English, French, Spanish, Italian), executes with Windows 2000 Professional/ 2000 Server or Windows XP Professional/ Server 2003

Type of delivery: License key disk, certificate of license, terms and conditions

- Floating license for 1 user

6ES7 841-0CC04-0YA5

Ordering data for previous version SIMATIC PCS 7 V6.1

OS software V6.1

OS standard software for single station / server / client

Selection and Ordering Data	Order No.	Selection and Ordering Data	Order No.
OS Software Single Station		OS Software Server	
SIMATIC PCS 7 OS Software Single Station V6.1 3 languages (German, English, French), executes with Windows 2000 Professional or Windows XP Professional, single license for 1 installation Electronic documentation on PCS 7 toolset DVD Type of delivery: License key disk, emergency key disk, certificate of license, terms and conditions; PCS 7 V6.1 toolset DVD, Microsoft SQL Server including EULA, PC Anywhere Host and supplementary CDs/DVDs (e.g. Microsoft ServicePacks and tools)		SIMATIC PCS 7 OS Software Server V6.1 3 languages (German, English, French), executes with Windows 2000 Server or Windows Server 2003, single license for 1 installation Electronic documentation on PCS 7 toolset DVD Type of delivery: License key disk, emergency key disk, certificate of license, terms and conditions; PCS 7 V6.1 toolset DVD, Microsoft SQL Server including EULA, PC Anywhere Host and supplementary CDs/DVDs (e.g. Microsoft ServicePacks and tools)	
<ul style="list-style-type: none"> • 250 POs/RT 8K ¹⁾ • 1000 POs/RT 32K • 2000 POs/RT 64K • 3000 POs/RT 100K • 5000 POs/RT 150K 	6ES7 658-2AA16-0YA0 6ES7 658-2AB16-0YA0 6ES7 658-2AC16-0YA0 6ES7 658-2AD16-0YA0 6ES7 658-2AE16-0YA0	<ul style="list-style-type: none"> • 250 POs/RT 8K • 1000 POs/RT 32K • 2000 POs/RT 64K • 3000 POs/RT 100K • 5000 POs/RT 150K • 8500 POs/RT 256K 	6ES7 658-2BA16-0YA0 6ES7 658-2BB16-0YA0 6ES7 658-2BC16-0YA0 6ES7 658-2BD16-0YA0 6ES7 658-2BE16-0YA0 6ES7 658-2BF16-0YA0
SIMATIC PCS 7 PowerPack OS Software Single Station V6.1		SIMATIC PCS 7 PowerPack OS Software Server V6.1	
for extending the OS software for a single station 3 languages (German, English, French), executes with Windows 2000 Professional or Windows XP Professional, single license for 1 installation Type of delivery: License key disk, emergency key disk, certificate of license, terms and conditions		for extending the OS Software Server 3 languages (German, English, French), executes with Windows 2000 Server or Windows Server 2003, single license for 1 installation Type of delivery: License key disk, emergency key disk, certificate of license, terms and conditions	
<ul style="list-style-type: none"> • From 250 POs/RT 8K to 1000 POs/RT 32K • From 1000 POs/RT 32K to 2000 POs/RT 64K • From 2000 POs/RT 64K to 3000 POs/RT 100K • From 3000 POs/RT 100K to 5000 POs/RT 150K 	6ES7 658-2AB16-0YD0 6ES7 658-2AC16-0YD0 6ES7 658-2AD16-0YD0 6ES7 658-2AE16-0YD0	<ul style="list-style-type: none"> • From 250 POs/RT 8K to 1000 POs/RT 32K • From 1000 POs/RT 32K to 2000 POs/RT 64K • From 2000 POs/RT 64K to 3000 POs/RT 100K • From 3000 POs/RT 100K to 5000 POs/RT 150K • From 5000 POs/RT 150K to 8500 POs/RT 256K 	6ES7 658-2BB16-0YD0 6ES7 658-2BC16-0YD0 6ES7 658-2BD16-0YD0 6ES7 658-2BE16-0YD0 6ES7 658-2BF16-0YD0
OS Software Client		OS Software Client	
SIMATIC PCS 7 OS Software Client V6.1 3 languages (German, English, French), executes with Windows 2000 Professional or Windows XP Professional, floating license for 1 user Electronic documentation on PCS 7 toolset DVD Type of delivery: License key disk, emergency key disk, certificate of license, terms and conditions; PCS 7 V6.1 toolset DVD, Microsoft SQL Server including EULA, PC Anywhere Host and supplementary CDs/DVDs (e.g. Microsoft ServicePacks and tools)		6ES7 658-2CX16-0YA5	

¹⁾ A process object (PO) is a synonym for an operable and observable block with approx. 30 variables.

Ordering data for previous version SIMATIC PCS 7 V6.1

OS software V6.1

OS archiving

Selection and Ordering Data

Order No.

Expansion of integral high-performance cyclic buffer archive (512 variables) of OS Single Station and OS Server

SIMATIC PCS 7 PowerPack OS Archive V6.1

3 languages (German, English, French), executes with Windows 2000 Professional/ 2000 Server or Windows XP Professional/ Server 2003, single license for 1 installation

Type of delivery:

License key disk, emergency key disk, certificate of license, terms and conditions

- For expansion from 512 to 1500 variables
- For expansion from 1500 to 5000 variables
- For expansion from 5000 to 10000 variables

6ES7 658-2EA16-2YD0

6ES7 658-2EB16-2YD0

6ES7 658-2EE16-2YD0

SIMATIC PCS 7 Bundle OS Archive V6.1

3 languages (German, English, French), executes with Windows 2000 Professional/ 2000 Server or Windows XP Professional/ Server 2003, single license for 1 installation

Type of delivery:

4 license key disks, emergency key disk, certificate of license, terms and conditions

- 4 x 5000 variables for 4 stations each (Single Station/Server)

6ES7 652-1EA16-2YB0

SFC Visualization

Selection and Ordering Data

Order No.

SIMATIC PCS 7 SFC Visualization V6.1

for displaying and operating SFC sequence controls on an operator station

3 languages (German, English, French), executes with Windows 2000 Professional or Windows XP Professional, floating license for 1 user

Type of delivery:

License key disk, emergency key disk, certificate of license, terms and conditions

6ES7 652-0XD16-2YB5

SIMATIC PCS 7 Upgrade SFC Visualization V5.x to V6.1

3 languages (German, English, French), executes with Windows 2000 Professional or Windows XP Professional, floating license for 1 user

Type of delivery:

License key disk, emergency key disk, certificate of license, terms and conditions

6ES7 652-0XD16-2YF5

SIMATIC Safety Matrix Viewer

Selection and Ordering Data

Order No.

SIMATIC Safety Matrix Viewer for SIMATIC PCS 7

Operation and monitoring of the safety matrix in the SIMATIC PCS 7 environment with several operating levels

2 languages (German, English), executes with Windows 2000 Professional, Windows XP Professional or Windows 2003 Server, single license for 1 installation

Type of delivery: Certificate of license and authorization diskette; software and electronic documentation on CD

6ES7 833-1SM60-0YA5 C)

Connectivity Pack and Client Access Licenses

Selection and Ordering Data

Order No.

WinCC/Connectivity Pack

Single license for 1 installation

6AV6 371-1DR06-1AX0

WinCC/Client Access License

for access of (office) computers (without WinCC installation) to archive and alarm data of an operator station (OS single station/OS server) per OPC HDA, OPC A&E or OLE-DB

Single license for 1 installation

6AV6 371-1ES06-0AX0

WinCC/Client Access License per Prozessor

for access of client to archive and alarm data of an operator station (OS single station/OS server) per OPC HDA, OPC A&E or OLE-DB

License for any number of clients per processor

6AV6 371-1ES06-0CX0

C) Subject to export regulations: AL: N, ECCN: EAR99S

Ordering data for previous version SIMATIC PCS 7 V6.1

OS software V6.1

OS redundancy

Selection and Ordering Data	Order No.
Design of redundant OS single stations	
WinCC/Redundancy V6.0 SP3 for alignment of archives following OS restart; single license for 2 installations Installation required on each of the two redundant OS single stations	6AV6 371-1CF06-0DX0
Design of redundant OS servers	
SIMATIC PCS 7 Server Redundancy V6.1 3 languages (German, English, French), executes with Windows 2000 Server or Windows Server 2003, single license for 2 installations with OS Software Server und WinCC/Redundancy as well as RS 232 connecting cable, 10 m Type of delivery: 2 license key disks, emergency key disk, certificate of license, terms and conditions; PCS 7 V6.1 toolset DVD, Microsoft SQL Server including EULA, PC Anywhere Host and supplementary CDs/DVDs (e.g. Microsoft ServicePacks and tools)	
<ul style="list-style-type: none"> • 250 POs/RT 8K • 2000 POs/RT 64K • 3000 POs/RT 100K • 5000 POs/RT 150K • 8500 POs/RT 256K PowerPacks for PO expansion: see OS Software Server PowerPack V6.1 (2 PowerPacks each required)	6ES7 652-3XA16-2YA0 6ES7 652-3XC16-2YA0 6ES7 652-3XD16-2YA0 6ES7 652-3XE16-2YA0 6ES7 652-3XF16-2YA0

OS long-term archiving

Selection and Ordering Data	Order No.
SIMATIC StoragePlus V1.1 Software for long-term archiving of data from the SIMATIC PCS 7 process control system; for up to 4 single stations, servers or pairs of servers 3 languages (German, English, French), executes with Windows 2000 Professional/ 2000 Server or Windows XP Professional/ Server 2003, single license for 1 installation Type of delivery: License key disk, emergency key disk, certificate of license, terms and conditions	6ES7 652-0XC11-2YB0
SIMATIC PCS 7 Central Archive Server V6.1 Software for long-term archiving of data from the SIMATIC PCS 7 process control system; for up to 11 servers or pairs of servers 3 languages (German, English, French), executes with Windows Server 2003, single license for 1 installation Type of delivery: License key disk, emergency key disk, certificate of license, terms and conditions	6ES7 658-2FX16-0YB0

Ordering data for previous version SIMATIC PCS 7 V6.1

SIMATIC BATCH Software V6.1

PCS 7 Web Server

Selection and Ordering Data	Order No.	Selection and Ordering Data	Order No.
SIMATIC PCS 7 Web Server V6.1 3 languages (German, English, French), executes with Windows Server 2003, single license for 1 installation Type of delivery: License key disk, emergency key disk, certificate of license, terms and conditions <ul style="list-style-type: none"> • For 3 clients • For 10 clients • For 25 clients • For 50 clients 	6ES7 658-2GA16-2YB0 6ES7 658-2GB16-2YB0 6ES7 658-2GC16-2YB0 6ES7 658-2GD16-2YB0	OS Software Client SIMATIC PCS 7 OS Software Client V6.1¹⁾ 3 languages (German, English, French), executes with Windows 2000 Professional or Windows XP Professional, floating license for 1 user Electronic documentation on PCS 7 toolset DVD Type of delivery: <ul style="list-style-type: none"> • License key disk, emergency key disk, certificate of license, terms and conditions • PCS 7 V6.1 toolset DVD, Microsoft SQL Server including EULA and supplementary CDs/DVDs (e.g. Microsoft ServicePacks and tools) 	6ES7 658-2CX16-0YA5
SIMATIC PCS 7 PowerPack Web Server V6.1 3 languages (German, English, French), executes with Windows Server 2003, single license for 1 installation Type of delivery: License key disk, emergency key disk, certificate of license, terms and conditions For expansion of PCS 7 Web server license <ul style="list-style-type: none"> • From 3 to up to 10 clients • From 10 to up to 25 clients • From 25 to up to 50 clients 	6ES7 658-2GB16-2YD0 6ES7 658-2GC16-2YD0 6ES7 658-2GD16-2YD0	SIMATIC PCS 7 Web Diagnostics Client V6.1 3 languages (German, English, French), executes with Windows Server 2003, single license for 1 installation Type of delivery: License key disk, emergency key disk, certificate of license, terms and conditions	6ES7 658-2JX16-2YB0
		SIMATIC PCS 7 Web Diagnostics Server V6.1 3 languages (German, English, French), executes with Windows Server 2003, single license for 1 installation Type of delivery: License key disk, emergency key disk, certificate of license, terms and conditions	6ES7 658-2HX16-2YB0
¹⁾ Deviating from the specification in the ordering data, the license of the OS Software Client V6.1 in this special application is also enabled for the Microsoft Windows Server 2003 operating system.			
Selection and Ordering Data	Order No.	Selection and Ordering Data	Order No.
SIMATIC BATCH Server Basic Package V6.1 (PO 150) For single station or client/server configuration, comprising <ul style="list-style-type: none"> • Batch server for 150 batch POs¹⁾ • Recipe System • Batch Control Center (BatchCC) 3 languages (German, English, French), executes with Windows 2000 Professional/ 2000 Server or Windows XP Professional/ Server 2003, single license for 1 installation Type of delivery: License key disk, certificate of license, terms and conditions	6ES7 657-0SA16-0YB0	SIMATIC BATCH PO Options V6.1 For expansion of the SIMATIC BATCH Server Basic Package 3 languages (German, English, French), executes with Windows 2000 Professional/ 2000 Server or Windows XP Professional/ Server 2003, single license for 1 installation Type of delivery: License key disk, certificate of license, terms and conditions <ul style="list-style-type: none"> • To batch with 300 POs • To batch with 600 POs • To batch with 1800 POs • To batch with unlimited POs 	6ES7 657-0XE16-2YB0 6ES7 657-0XB16-2YB0 6ES7 657-0XC16-2YB0 6ES7 657-0XD16-2YB0

Ordering data for previous version SIMATIC PCS 7 V6.1

Route Control Software V6.1

Selection and Ordering Data	Order No.	Selection and Ordering Data	Order No.
SIMATIC BATCH PowerPacks V6.1 For expansion of batch POs 3 languages (German, English, French), executes with Windows 2000 Professional/ 2000 Server or Windows XP Professional/ Server 2003, single license for 1 installation Type of delivery: License key disk, certificate of license, terms and conditions <ul style="list-style-type: none"> From batch with 300 POs to batch with 600 POs From batch with 600 POs to batch with 1800 POs From batch with 1800 POs to batch with unlimited POs 	6ES7 657-0XB16-2YD0 6ES7 657-0XC16-2YD0 6ES7 657-0XD16-2YD0	SIMATIC BATCH Separation Procedures/ Formulas V6.1 3 languages (German, English, French), executes with Windows 2000 Professional/ 2000 Server or Windows XP Professional/ Server 2003, single license for 1 installation Type of delivery: License key disk, certificate of license, terms and conditions	6ES7 657-0HX16-2YB0
SIMATIC BATCH BatchCC V6.1 3 languages (German, English, French), executes with Windows 2000 Professional/ 2000 Server or Windows XP Professional/ Server 2003, floating license for 1 user Type of delivery: License key disk, certificate of license, terms and conditions	6ES7 657-0LX16-2YB5	SIMATIC BATCH API V6.1 1 language (English), executes with Windows 2000 Professional/ 2000 Server or Windows XP Professional/ Server 2003, single license for 1 installation Type of delivery: License key disk, certificate of license, terms and conditions	6ES7 657-0MX16-2YB0
SIMATIC BATCH Recipe System V6.1 3 languages (German, English, French), executes with Windows 2000 Professional/ 2000 Server or Windows XP Professional/ Server 2003, floating license for 1 user Type of delivery: License key disk, certificate of license, terms and conditions	6ES7 657-0AX16-2YB5	SIMATIC Route Control Server V6.1 for up to 30 simultaneous material transports For single station and client/server configuration 3 languages (German, English, French), executes with Windows 2000 Server or Windows Server 2003, single license for 1 installation Type of delivery: License key disk, emergency key disk, certificate of license, terms and conditions	6ES7 658-7FA16-0YB0
SIMATIC BATCH Batch Planning V6.1 3 languages (German, English, French), executes with Windows 2000 Professional/ 2000 Server or Windows XP Professional/ Server 2003, floating license for 1 user Type of delivery: License key disk, certificate of license, terms and conditions	6ES7 657-0BX16-2YB5	SIMATIC Route Control Server PowerPack V6.1 for expansion of SIMATIC Route Control Server 3 languages (German, English, French), executes with Windows 2000 Server or Windows Server 2003, single license for 1 installation Type of delivery: License key disk, emergency key disk, certificate of license, terms and conditions <ul style="list-style-type: none"> From 30 to up to 100 simultaneous material transports From 100 to up to 300 simultaneous material transports 	6ES7 658-7FB16-0YD0 6ES7 658-7FC16-0YD0
SIMATIC BATCH Hierarchical Recipe V6.1 3 languages (German, English, French), executes with Windows 2000 Professional/ 2000 Server or Windows XP Professional/ Server 2003, single license for 1 installation Type of delivery: License key disk, certificate of license, terms and conditions	6ES7 657-0FX16-2YB0		
SIMATIC BATCH ROP Library V6.1 3 languages (German, English, French), executes with Windows 2000 Professional/ 2000 Server or Windows XP Professional/ Server 2003, single license for 1 installation Type of delivery: License key disk, certificate of license, terms and conditions	6ES7 657-0GX16-2YB0		

¹⁾ Whereas process objects (PO) represent operable and observable blocks with approx. 30 variables, batch process objects (batch POs) represent instances of plant units and equipment modules (EPH/EOP).

Ordering data for previous version SIMATIC PCS 7 V6.1

Asset Management Software V6.1

Selection and Ordering Data	Order No.	Selection and Ordering Data	Order No.
SIMATIC Route Control Center V6.1 3 languages (German, English, French), executes with Windows 2000 Professional or Windows XP Professional, floating license for 1 user Type of delivery: License key disk, emergency key disk, certificate of license, terms and conditions	6ES7 658-7EX16-0YB5	SIMATIC PCS 7 Asset Runtime V6.1 incl. 128 asset TAGs ¹⁾ and one OPC server license For installation on SIMATIC PCS 7 BOX, single station or client 3 languages (German, English, French), executes with Windows 2000 Professional/ 2000 Server or Windows XP Professional/ Server 2003, single license for 1 installation Type of delivery: License key disk, emergency key disk, certificate of license, terms and conditions	6ES7 658-7GA16-0YB0
SIMATIC Route Control Engineering V6.1 3 languages (German, English, French), executes with Windows 2000 Professional/ 2000 Server or Windows XP Professional/ Server 2003 Type of delivery: License key disk, emergency key disk, certificate of license, terms and conditions • Floating license for 1 user	6ES7 658-7DX16-0YB5	SIMATIC PCS 7 PowerPack Asset Runtime V6.1 for expanding the TAGs of SIMATIC PCS 7 Asset Runtime V6.1 3 languages (German, English, French), executes with Windows 2000 Professional/ 2000 Server or Windows XP Professional/ Server 2003, single license for 1 installation Type of delivery: License key disk, emergency key disk, certificate of license, terms and conditions • From 128 to 512 asset TAGs, incl. one OPC server license • From 512 to 1024 asset TAGs • From 1024 to 2048 asset TAGs • From 2048 to unlimited asset TAGs	6ES7 658-7GB16-0YD0 6ES7 658-7GC16-0YD0 6ES7 658-7GD16-0YD0 6ES7 658-7GH16-0YD0

Ordering data for previous version SIMATIC PCS 7 V6.1

PROFIBUS PA components

Selection and Ordering Data	Order No.	Selection and Ordering Data	Order No.
Asset Engineering			
SIMATIC PCS 7 Asset Engineering V6.1	6ES7 658-7GX16-0YB5	DP/PA Coupler	
For installation on SIMATIC PCS 7 BOX, single station or client		For transition from RS 485 to MBP	
3 languages (German, English, French), executes with Windows 2000 Professional/ 2000 Server or Windows XP Professional/ Server 2003, floating license for 1 user		• Ex version	6ES7 157-0AD82-0XA0
Type of delivery: License key disk, emergency key disk, certificate of license, terms and conditions		• Non-Ex version	6ES7 157-0AC82-0XA0
1) With asset TAGs, the number of asset objects monitored in SIMATIC PCS 7 is licensed. An asset object represents individual hardware components within a SIMATIC PCS 7 project, e.g. - measuring devices, positioners, switchgear or remote I/Os monitored per EDD or - basic devices or Ethernet components monitored in the maintenance station via an OPC link. In conjunction with PowerPacks, licenses are available for 128, 512, 1024, 2048 and unlimited asset TAGs.		IM 153-2 High Feature Interface module for DP/PA Link and Y-Link	6ES7 153-2BA81-0XB0 B)
		Accessories	
		PS 307 Load Power Supply Including connection assembly; 120/230 V AC; 24 V DC	
		• 2 A; 50 mm wide	6ES7 307-1BA00-0AA0
		• 5 A; 80 mm wide	6ES7 307-1EA00-0AA0
		• 5 A, extended temperature range; 80 mm wide	6ES7 307-1EA80-0AA0
		• 10 A, 200 mm wide	6ES7 307-1KA01-0AA0
		PS 305 Load Power Supply 24/48/60/110 V DC; 24 V DC	
		• 2 A, extended temperature range; 80 mm wide	6ES7 305-1BA80-0AA0
		Standard profile rails (without hot swapping function)	
		• 482 mm wide (19 inches)	6ES7 390-1AE80-0AA0
		• 530 mm wide	6ES7 390-1AF30-0AA0
		B) Subject to export regulations: AL: N, ECCN: EAR99H	

Ordering data for previous version SIMATIC PCS 7 V6.1

PROFIBUS PA components

Selection and Ordering Data Order No.

Components for hot swapping and for redundant design

Active bus modules for hot swapping

- **BM IM 157**
For two IM 153-2 High Feature modules, for redundant and non-redundant configuration, for extended temperature range, for hot swapping function, permissible operating temperature -25 ... +60 °C
- **BM DP/PA**
For one DP/PA coupler, for extended temperature range, for hot swapping function, permissible operating temperature -25 ... +60 °C

6ES7 195-7HD80-0XA0

6ES7 195-7HF80-0XA0

Profile rail for hot swapping

For max. 5 active bus modules

- 482 mm wide (19 inches)
- 530 mm wide
- 620 mm wide

6ES7 195-1GA00-0XA0

6ES7 195-1GF30-0XA0

6ES7 195-1GG30-0XA0

Ordering data for previous version SIMATIC PCS 7 V6.1

Automation systems

Standard automation systems (bundles)

Selection and Ordering Data	Order No.	Selection and Ordering Data	Order No.
Ordering units for SIMATIC PCS 7 standard automation systems with Industrial Ethernet interfacing via CP		AS 416-2 automation system	
AS 414-3 automation system		comprising:	
comprising:		SIMATIC PCS 7 AS Runtime license for 100 POs (applies to SIMATIC PCS 7 V6.1 also as Runtime license PCS 7 Library Blocks)	
SIMATIC PCS 7 AS Runtime license for 100 POs (applies to SIMATIC PCS 7 V6.1 also as Runtime license PCS 7 Library Blocks)		Controller type 416-2 with 2 interfaces (MPI/DP and DP), 5.6 MB main memory (2.8 MB each for program and data), CP 443-1 communications processor for connection to Industrial Ethernet plant bus as well as	
Controller type 414-3 with 3 interfaces (MPI/DP, DP and slot for IF module), 2.8 MB main memory (1.4 MB each for program and data), CP 443-1 communications processor for connection to Industrial Ethernet plant bus as well as		<ul style="list-style-type: none"> Aluminum UR1 rack (18 slots): 	
<ul style="list-style-type: none"> PS 407 power supply; 20 A for 120/230 V AC/DC, 2 backup batteries, memory card 2 MB RAM 	6ES7 654-3QD48-0XX0	<ul style="list-style-type: none"> PS 407 power supply; 20 A for 120/230 V AC/DC, 2 backup batteries, memory card 4 MB RAM 	6ES7 654-3JE48-0XX0
<ul style="list-style-type: none"> PS 407 power supply; 20 A for 120/230 V AC/DC, 2 backup batteries, memory card 2 MB RAM 	6ES7 654-3QE48-0XX0 B)	<ul style="list-style-type: none"> PS 407 power supply; 20 A for 120/230 V AC/DC, 2 backup batteries, memory card 8 MB RAM 	6ES7 654-3JF48-0XX0 B)
<ul style="list-style-type: none"> PS 405 power supply; 20 A for 24 V DC, 2 backup batteries, memory card 2 MB RAM 	6ES7 654-6QD48-0XX0	<ul style="list-style-type: none"> PS 405 power supply; 20 A for 24 V DC, 2 backup batteries, memory card 4 MB RAM 	6ES7 654-6JE48-0XX0
<ul style="list-style-type: none"> PS 405 power supply; 20 A for 24 V DC, 2 backup batteries, memory card 2 MB RAM 	6ES7 654-6QE48-0XX0 B)	<ul style="list-style-type: none"> PS 405 power supply; 20 A for 24 V DC, 2 backup batteries, memory card 8 MB RAM 	6ES7 654-6JF48-0XX0 B)
<ul style="list-style-type: none"> Without power supply, without backup batteries, without memory card 	6ES7 654-0QX48-0XX0	<ul style="list-style-type: none"> Without power supply, without backup batteries, without memory card 	6ES7 654-0JX48-0XX0
<ul style="list-style-type: none"> Aluminum UR2 rack (9 slots): 		<ul style="list-style-type: none"> Aluminum UR2 rack (9 slots): 	
<ul style="list-style-type: none"> PS 407 power supply; 10 A for 120/230 V AC/DC, 2 backup batteries, memory card 2 MB RAM 	6ES7 654-1QD58-0XX0	<ul style="list-style-type: none"> PS 407 power supply; 10 A for 120/230 V AC/DC, 2 backup batteries, memory card 4 MB RAM 	6ES7 654-1JE58-0XX0
<ul style="list-style-type: none"> PS 407 power supply; 10 A for 120/230 V AC/DC, 2 backup batteries, memory card 2 MB RAM 	6ES7 654-1QE58-0XX0 B)	<ul style="list-style-type: none"> PS 407 power supply; 10 A for 120/230 V AC/DC, 2 backup batteries, memory card 8 MB RAM 	6ES7 654-1JF58-0XX0 B)
<ul style="list-style-type: none"> PS 405 power supply; 10 A for 24 V DC, 2 backup batteries, memory card 2 MB RAM 	6ES7 654-4QD58-0XX0	<ul style="list-style-type: none"> PS 405 power supply; 10 A for 24 V DC, 2 backup batteries, memory card 4 MB RAM 	6ES7 654-4JE58-0XX0
<ul style="list-style-type: none"> PS 405 power supply; 10 A for 24 V DC, 2 backup batteries, memory card 2 MB RAM 	6ES7 654-4QE58-0XX0 B)	<ul style="list-style-type: none"> PS 405 power supply; 10 A for 24 V DC, 2 backup batteries, memory card 8 MB RAM 	6ES7 654-4JF58-0XX0 B)
<ul style="list-style-type: none"> Without power supply, without backup batteries, without memory card 	6ES7 654-0QX58-0XX0	<ul style="list-style-type: none"> Without power supply, without backup batteries, without memory card 	6ES7 654-0JX58-0XX0

B) Subject to export regulations: AL: N, ECCN: EAR99H

Ordering data for previous version SIMATIC PCS 7 V6.1

Automation systems

Selection and Ordering Data	Order No.	Selection and Ordering Data	Order No.
AS 416-3 automation system comprising: SIMATIC PCS 7 AS Runtime license for 100 POs (applies to SIMATIC PCS 7 V6.1 also as Runtime license PCS 7 Library Blocks) Controller type 416-3 with 3 interfaces (MPI/DP, DP and slot for IF module), 11,2 MB main memory (5,6 MB each for program and data), CP 443-1 communications processor for connection to Industrial Ethernet plant bus as well as <ul style="list-style-type: none"> Aluminum UR1 rack (18 slots): <ul style="list-style-type: none"> PS 407 power supply; 20 A for 120/230 V AC/DC, 2 backup batteries, memory card 8 MB RAM PS 407 power supply; 20 A for 120/230 V AC/DC, 2 backup batteries, memory card 16 MB RAM PS 405 power supply; 20 A for 24 V DC, 2 backup batteries, memory card 8 MB RAM PS 405 power supply; 20 A for 24 V DC, 2 backup batteries, memory card 16 MB RAM Without power supply, without backup batteries, without memory card Aluminum UR2 rack (9 slots): <ul style="list-style-type: none"> PS 407 power supply; 10 A for 120/230 V AC/DC, 2 backup batteries, memory card 8 MB RAM PS 407 power supply; 10 A for 120/230 V AC/DC, 2 backup batteries, memory card 16 MB RAM PS 405 power supply; 10 A for 24 V DC, 2 backup batteries, memory card 8 MB RAM PS 405 power supply; 10 A for 24 V DC, 2 backup batteries, memory card 16 MB RAM Without power supply, without backup batteries, without memory card 	6ES7 654-3KF48-0XX0 6ES7 654-3KG48-0XX0 B) 6ES7 654-6KF48-0XX0 6ES7 654-6KG48-0XX0 B) 6ES7 654-0KX48-0XX0 6ES7 654-1KF58-0XX0 6ES7 654-1KG58-0XX0 B) 6ES7 654-4KF58-0XX0 6ES7 654-4KG58-0XX0 B) 6ES7 654-0KX58-0XX0	AS 417-4 automation system comprising: SIMATIC PCS 7 AS Runtime license for 100 POs (applies to SIMATIC PCS 7 V6.1 also as Runtime license PCS 7 Library Blocks) Controller type 417-4 with 4 interfaces (MPI/DP, DP and 2 slots for IF modules), 30 MB main memory (15 MB each for program and data), CP 443-1 communications processor for connection to Industrial Ethernet plant bus as well as <ul style="list-style-type: none"> Aluminum UR1 rack (18 slots): <ul style="list-style-type: none"> PS 407 power supply; 20 A for 120/230 V AC/DC, 2 backup batteries, memory card 4 MB RAM PS 407 power supply; 20 A for 120/230 V AC/DC, 2 backup batteries, memory card 16 MB RAM PS 405 power supply; 20 A for 24 V DC, 2 backup batteries, memory card 4 MB RAM PS 405 power supply; 20 A for 24 V DC, 2 backup batteries, memory card 16 MB RAM Without power supply, without backup batteries, without memory card Aluminum UR2 rack (9 slots): <ul style="list-style-type: none"> PS 407 power supply; 10 A for 120/230 V AC/DC, 2 backup batteries, memory card 4 MB RAM PS 407 power supply; 10 A for 120/230 V AC/DC, 2 backup batteries, memory card 16 MB RAM PS 405 power supply; 10 A for 24 V DC, 2 backup batteries, memory card 4 MB RAM PS 405 power supply; 10 A for 24 V DC, 2 backup batteries, memory card 16 MB RAM Without power supply, without backup batteries, without memory card 	6ES7 654-3LE48-0XX0 6ES7 654-3LG48-0XX0 6ES7 654-6LE48-0XX0 6ES7 654-6LG48-0XX0 6ES7 654-0LX48-0XX0 6ES7 654-1LE58-0XX0 6ES7 654-1LG58-0XX0 6ES7 654-4LE58-0XX0 6ES7 654-4LG58-0XX0 6ES7 654-0LX58-0XX0

B) Subject to export regulations: AL: N, ECCN: EAR99H

Ordering data for previous version SIMATIC PCS 7 V6.1

Automation systems

Fault-tolerant/safety-related automation systems (bundles)

Selection and Ordering Data	Order No.	Selection and Ordering Data	Order No.
<p>AS 414-4-1H automation system Prepared system with one CPU 414-4H for physically separated redundant systems, for F systems or for later upgrading to a redundant system</p> <p>comprising:</p> <p>SIMATIC PCS 7 AS Runtime license for 100 POs (applies to SIMATIC PCS 7 V6.1 also as Runtime license PCS 7 Library Blocks)</p> <p>Controller type 414-4-1H with 2 integrated interfaces (MPI/DP master and DP master), 2.8 MB main memory (1.4 MB each for program and data), CP 443-1 communications processor for connection to Industrial Ethernet plant bus as well as</p> <ul style="list-style-type: none"> Aluminum UR1 rack (18 slots), <u>without sync modules</u> <ul style="list-style-type: none"> Without power supply, without backup batteries, without memory card Aluminum UR2 rack (9 slots), <u>without sync modules</u> <ul style="list-style-type: none"> PS 407 power supply; 10 A for 120/230 V AC/DC, redundant design possible, 2 backup batteries, memory card 2 MB RAM PS 407 power supply; 10 A for 120/230 V AC/DC, redundant design possible, 2 backup batteries, memory card 4 MB RAM PS 405 power supply; 10 A for 24 V DC, 2 backup batteries, memory card 2 MB RAM PS 405 power supply; 10 A for 24 V DC, 2 backup batteries, memory card 4 MB RAM Without power supply, without backup batteries, without memory card 	<p>6ES7 654-0MX48-0XX0</p> <p>6ES7 654-2MD58-0XX0</p> <p>6ES7 654-2ME58-0XX0</p> <p>6ES7 654-4MD58-0XX0</p> <p>6ES7 654-4ME58-0XX0</p> <p>6ES7 654-0MX58-0XX0</p>	<p>AS 414-4-2H automation system Complete fault-tolerant system with two CPUs 414-4H</p> <p>comprising:</p> <p>SIMATIC PCS 7 AS Runtime license for 100 POs (applies to SIMATIC PCS 7 V6.1 also as Runtime license PCS 7 Library Blocks)</p> <p>Controller type 414-4-2H with 2 x 2 integrated interfaces (MPI/DP master and DP master), 2 x 2.8 MB main memory (1.4 MB each for program and data), two CP 443-1 communications processors for connection to Industrial Ethernet plant bus as well as</p> <ul style="list-style-type: none"> Aluminium UR2-H rack (2 x 9 slots), <u>with 4 sync modules</u> for distances up to 10 m and 2 fiber-optic sync cables, 1 m <ul style="list-style-type: none"> Two PS 407 power supplies; 10 A for 120/230 V AC/DC, redundant design possible, 4 backup batteries, 2 memory cards of 2 MB RAM each Two PS 407 power supplies; 10 A for 120/230 V AC/DC, redundant design possible, 4 backup batteries, 2 memory cards of 4 MB RAM each Two PS 405 power supplies; 10 A for 24 V DC, 4 backup batteries, 2 memory cards of 2 MB RAM each Two PS 405 power supplies; 10 A for 24 V DC, 4 backup batteries, 2 memory cards of 4 MB RAM each Without power supply, without backup batteries, without memory card 	<p>6ES7 654-2ND68-0XC0</p> <p>6ES7 654-2NE68-0XC0</p> <p>6ES7 654-4ND68-0XC0</p> <p>6ES7 654-4NE68-0XC0</p> <p>6ES7 654-0NX68-0XC0</p>

Ordering data for previous version SIMATIC PCS 7 V6.1

Automation systems

Selection and Ordering Data

Order No.

AS 417-4-1H automation system

Prepared system with one CPU 417-4H for physically separated redundant systems, for F systems or for later upgrading to a redundant system

comprising:

SIMATIC PCS 7 AS Runtime license for 100 POs (applies to SIMATIC PCS 7 V6.1 also as Runtime license PCS 7 Library Blocks)

Controller type 417-4-1H with 2 integrated interfaces (MPI/DP master and DP master), 30 MB main memory (15 MB each for program and data), CP 443-1 communications processor for connection to Industrial Ethernet plant bus as well as

- Aluminum UR1 rack (18 slots), without sync modules
 - Without power supply, without backup batteries, without memory card
- Aluminum UR2 rack (9 slots), without sync modules
 - PS 407 power supply; 10 A for 120/230 V AC/DC, redundant design possible, 2 backup batteries, memory card 4 MB RAM
 - PS 407 power supply; 10 A for 120/230 V AC/DC, redundant design possible, 2 backup batteries, memory card 16 MB RAM
 - PS 405 power supply; 10 A for 24 V DC, 2 backup batteries, memory card 4 MB RAM
 - PS 405 power supply; 10 A for 24 V DC, 2 backup batteries, memory card 16 MB RAM
 - Without power supply, without backup batteries, without memory card

6ES7 654-0RX48-0XX0

6ES7 654-2RE58-0XX0

6ES7 654-2RG58-0XX0

6ES7 654-4RE58-0XX0

6ES7 654-4RG58-0XX0

6ES7 654-0RX58-0XX0

Selection and Ordering Data

Order No.

AS 417-4-2H automation system

Complete fault-tolerant system with two CPUs 417-4H

comprising:

SIMATIC PCS 7 AS Runtime license for 100 POs (applies to SIMATIC PCS 7 V6.1 also as Runtime license PCS 7 Library Blocks)

Controller type 417-4-2H with 2 x 2 integrated interfaces (MPI/DP master and DP master), 2 x 30 MB main memory (15 MB each for program and data), two CP 443-1 communications processors for connection to Industrial Ethernet plant bus as well as

- Aluminium UR2-H rack (2 x 9 slots), with 4 sync modules for distances up to 10 m and 2 fiber-optic sync cables, 1 m
 - Two PS 407 power supplies; 10 A for 120/230 V AC/DC, redundant design possible, 4 backup batteries, 2 memory cards of 4 MB RAM each
 - Two PS 407 power supplies; 10 A for 120/230 V AC/DC, redundant design possible, 4 backup batteries, 2 memory cards of 8 MB RAM each
 - Two PS 407 power supplies; 10 A for 120/230 V AC/DC, redundant design possible, 4 backup batteries, 2 memory cards of 16 MB RAM each
 - Two PS 405 power supplies; 10 A for 24 V DC, 4 backup batteries, 2 memory cards of 4 MB RAM each
 - Two PS 405 power supplies; 10 A for 24 V DC, 4 backup batteries, 2 memory cards of 8 MB RAM each
 - Two PS 405 power supplies; 10 A for 24 V DC, 4 backup batteries, 2 memory cards of 16 MB RAM each
 - Without power supply, without backup batteries, without memory card

6ES7 654-2PE68-0XC0

6ES7 654-2PF68-0XC0 B)

6ES7 654-2PG68-0XC0

6ES7 654-4PE68-0XC0

6ES7 654-4PF68-0XC0

6ES7 654-4PG68-0XC0

6ES7 654-0PX68-0XC0

B) Subject to export regulations: AL: N, ECCN: EAR99H

S7 F Systems Runtime License

Selection and Ordering Data

Order No.

S7 F Systems RT License

For processing safety-related application programs, for one AS 414F/FH or AS 417F/FH system

6ES7 833-1CC00-6YX0

Update/ upgrade packages



- 15/2 Software Update Service
- 15/4 Software/licenses for system communication via Industrial Ethernet
- 15/6 SIMATIC PDM upgrades
- 15/7 Upgrades for engineering system
- 15/8 Upgrades for operator system
- 15/10 Upgrades for SIMATIC BATCH
- 15/11 Upgrades for SIMATIC Route Control
- 15/12 Upgrades for Asset Management

15/13 SIMATIC PCS 7 upgrades V4.02 to V6.1

- 15/13 SIMATIC PCS 7 upgrades V5.x/V6.0 to V6.1
- 15/16 SIMATIC PCS 7 upgrades V4.02 to V5.2



Update/upgrade packages

Software Update Service

Overview



Software Update Service for SIMATIC PCS 7

Siemens offers a low-cost Software Update Service (SUS) for the SIMATIC PCS 7 software. If you utilize this service, you participate in the further development of the SIMATIC PCS 7 software you are using, and are always in possession of the latest release versions. You can participate in the Software Update Service for SIMATIC PCS 7 by purchasing SUS packages, and is only possible on the basis of the current software versions at the time of purchase.

The SUS packages represent a structural division of the SIMATIC PCS 7 software product range using functional and system-specific aspects. The number and composition of the package components identified as **list elements** are mainly characterized by license aspects (see "Design" for structure and contents). A list element can represent a single software product or also be a synonym for several products of the same type.

When purchasing **one** SUS package, you automatically receive all upgrades and ServicePacks for the software referred to in this SUS package for one year. Within this period of one year, you are therefore authorized to update **one** corresponding license from your stock for **each** list element in this package. The total number of SUS packages of one type which you require is therefore determined by the list element which includes most of the software licenses you use.

Delivery is to the address entered in the order. An SUS is automatically extended for a further year unless canceled no later than 3 months prior to expiration. Cancellation must be made in writing, and must be sent to the dispatch center with reference to the contract number.

Software Update Service for TIA products

In addition to the SUS for the SIMATIC PCS 7 process control system, there is also an SUS for SIMATIC PCS 7 products used in a different context (CFC, SIMATIC PDM) within the scope of Totally Integrated Automation (TIA). In the case of SIMATIC PDM, this is identical to the SUS PDM package for the Software Update Service for SIMATIC PCS 7.

The SUS range is rounded-off by the SUS for SIMATIC S7 products used in the context of SIMATIC PCS 7, e.g. SUS S7-PLCSIM.

Design

Structure and content of the SUS packages for the SIMATIC PCS 7 Software Update Service

Note:

Each item of an SUS package (list element) represents one software license.

SUS Engineering AS/OS

- PCS 7 Engineering AS/OS from 250 POs to unlimited POs
- PCS 7 Import/Export Assistant
- PCS 7 PID-Tuner
- Version Cross Manager
- Version Trail
- PCS 7 SFC Visualization
- PCS 7 BCE

SUS PDM

- PDM Single Point, 1 TAG
- PDM Basic from 4 TAGs to unlimited TAGs
- PDM Service from 128 TAGs to unlimited TAGs
- PDM S7 from 128 TAGs to unlimited TAGs
- PDM PCS 7 from 128 TAGs to unlimited TAGs
- PDM Integration in STEP 7/PCS 7
- PDM Routing S7 400
- PDM Standard HART Multiplexer

SUS Runtime OS

- PCS 7 OS Software Single Station from 250 POs to 5000 POs
- OS Software Server from 250 POs to 8500 POs
- PCS 7 OS Archive
- StoragePlus, PCS 7 Central Archive Server (CAS)
- PCS 7 OpenPCS 7 Server/OS Client (multi-functional)
- PCS 7 OpenPCS 7 Server (stand-alone)
- PCS 7 BCE
- PCS 7 SFC Visualization

SUS OS Client, SFC Visualization

- PCS 7 OS Software Client
- PCS 7 SFC Visualization

SUS OS Web Server

- PCS 7 OS Web Server from 3 clients to 50 clients
- PCS 7 OS Web Diagnostics Server
- PCS 7 OS Web Diagnostics Client

SUS Asset Management

- PCS 7 Asset Engineering
- PCS 7 Asset Runtime
- PCS 7 Asset Runtime Basic Package including 100 TAGs

Update/upgrade packages

Software Update Service

SUS SIMATIC BATCH Server

- PCS 7 SIMATIC BATCH Server Basic Package from 10 UNITS to unlimited UNITS
- PCS 7 SIMATIC BATCH Hierarchical Recipe
- PCS 7 SIMATIC BATCH ROP Library
- PCS 7 SIMATIC BATCH Separation Procedures/Formulas
- PCS 7 SIMATIC BATCH API

SUS SIMATIC BATCH Client

- PCS 7 SIMATIC BATCH Recipe System
- PCS 7 SIMATIC BATCH BatchCC
- PCS 7 SIMATIC BATCH Batch Planning

SUS SIMATIC Route Control

- PCS 7 SIMATIC Route Control Engineering
- PCS 7 SIMATIC Route Control Center
- PCS 7 SIMATIC Route Control Server: 30 to 300 simultaneous material transports
- PCS 7 BCE

Selection and Ordering Data

Order No.

SIMATIC PCS 7 Software Update Service

Subscription for 1 year with automatic extension; requirement: current software version

- | | |
|--|----------------------------|
| • PCS 7 Software Update Service for Engineering AS/OS | 6ES7 658-1XX00-0YL8 |
| • PCS 7 Software Update Service for PDM | 6ES7 658-3XX00-0YL8 |
| • PCS 7 Software Update Service for Runtime OS | 6ES7 658-2XX00-0YL8 |
| • PCS 7 Software Update Service for OS Client, SFC Visualization | 6ES7 658-2CX00-0YL8 |
| • PCS 7 Software Update Service for OS Web Server | 6ES7 658-2GX00-2YL8 |
| • PCS 7 Software Update Service for Asset Management | 6ES7 658-7GX00-0YL8 |
| • PCS 7 Software Update Service for SIMATIC BATCH Server | 6ES7 657-0SA00-0YL8 |
| • PCS 7 Software Update Service for SIMATIC BATCH Client | 6ES7 657-0XX00-2YL8 |
| • PCS 7 Software Update Service for Route Control | 6ES7 658-7DX00-0YL8 |

Software Update Service for TIA products

(SIMATIC PCS 7 products used in a different context as well as SIMATIC S7 products used with SIMATIC PCS 7)

Subscription for 1 year with automatic extension; requirement: current software version

- | | |
|---------------------------------------|----------------------------|
| • CFC Software Update Service | 6ES7 658-1EX00-2YL8 |
| • SIMATIC PDM Software Update Service | 6ES7 658-3XX00-0YL8 |
| • S7-PLCSIM Software Update Service | 6ES7 841-0CA01-0YX2 |

Update/upgrade packages

Software/licenses for system communication via Industrial Ethernet

Overview

With SIMATIC PCS 7, communications software and licenses of SIMATIC NET are used for the system communication via Industrial Ethernet. Their version cycle is not usually synchronous with that of SIMATIC PCS 7.

Whereas SIMATIC PCS 7 V7.0 communicates with SIMATIC NET products V6.4 (Edition 2006), the system components of SIMATIC PCS 7 V6.x only work together with SIMATIC NET products V6.3 (Edition 2005). Therefore the following ordering data again shows a comparison of the two versions.

When upgrading from SIMATIC PCS 7 V6.x to V7.0, it must be observed that a separate upgrade from V6.3 (Edition 2005) to V6.4 (Edition 2006) is only required for the S7-REDCONNECT communications software. For the other products, the version upgrade is implemented during the SIMATIC PCS 7 upgrade with the SIMATIC PCS 7 Upgrade Packages V6.x to V7.0.

Selection and Ordering Data

Order No.

Communications software/licenses for SIMATIC PCS 7 V7.0

SIMATIC NET S7-1613/2006 (V6.4) for Industrial Ethernet

S7 communications software for CP 1613, runtime software, in 2 languages (German, English), executes with Windows 2000 Professional/ 2000 Server/ XP Professional/ Server 2003, single license for 1 installation, software and electronic manual on CD-ROM, license key on diskette

6GK1 716-1CB64-3AA0

SIMATIC NET S7-REDCONNECT/2006 (V6.4)

Software for fail-safe S7 communication over redundant networks, for CP 1613, runtime software, in 2 languages (German, English), executes with Windows 2000 Professional/ 2000 Server/ XP Professional/ Server 2003, single license for 1 installation, software and electronic manual on CD-ROM, license key on diskette

6GK1 716-0HB64-3AA0

SIMATIC NET S7-REDCONNECT/2006 (V6.4) Upgrade

Software for expansion of S7-1613 to S7-REDCONNECT, runtime software, in 2 languages (German, English), executes with Windows 2000 Professional/ 2000 Server/ XP Professional/ Server 2003, single license for 1 installation, software and electronic manual on CD-ROM, license key on diskette

6GK1 716-0HB64-3AC0

Upgrade of S7-REDCONNECT communications software V6.3 (edition 2005) to V6.4 (edition 2006)

SIMATIC NET S7-REDCONNECT Upgrade from V6.3 to V6.4

Software for upgrading S7-REDCONNECT, runtime software, 2 languages (German, English), executes with Windows 2000 Professional/ 2000 Server/ XP Professional/ Server 2003, single license for 1 installation, software and electronic manual on CD-ROM, license key on diskette

6GK1 716-0HB64-3AE0

BCE license

PCS 7 BCE V7.0

Runtime license for plant bus communication via standard network card and Basic Communication Ethernet; already integrated in SIMATIC PCS 7 Industrial Workstations, in 3 languages (German, English, French), executes with Windows XP Professional or Windows Server 2003, floating license for 1 user

6ES7 650-1CD07-2YB5

Type of delivery: License key disk, certificate of license, terms and conditions

Update/upgrade packages

Software/licenses for system communication via Industrial Ethernet

Selection and Ordering Data	Order No.	Selection and Ordering Data	Order No.
<i>Communications software/licenses for SIMATIC PCS 7 V6.x</i>		<u>BCE license</u>	
SIMATIC NET S7-1613/2005 (V6.3) for Industrial Ethernet S7 communications software for CP 1613, runtime license without software, in 2 languages (German, English), executes with Windows 2000 Professional/ 2000 Server/ XP Professional/ Server 2003, single license for 1 installation, license key on diskette; software and electronic manual available on separate SIMATIC NET CD Edition 2005	6GK1 716-1CB63-3AB0	SOFTNET-S7/2005 for Industrial Ethernet Runtime license for plant bus communication via standard network card and Basic Communication Ethernet; already integrated with SIMATIC PCS 7 basic devices ES/OS/BATCH/IT, single license for 1 installation, license key on diskette; software and electronic manual available on separate SIMATIC NET CD Edition 2005	6GK1 704-1CW63-3AB0
SIMATIC NET S7-REDCONNECT/2005 (V6.3) for CP 1613, runtime license without software, for fail-safe S7 communication over redundant networks, in 2 languages (German, English), executes with Windows 2000 Professional/ 2000 Server/ XP Professional/ Server 2003, single license for 1 installation, license key on diskette; software and electronic manual available on separate SIMATIC NET CD Edition 2005	6GK1 716-0HB63-3AB0	SIMATIC NET CD Edition 2005 Runtime software for SIMATIC NET products, Edition 2005 (V6.3), in 2 languages (German, English), executes with Windows 2000 Professional/ 2000 Server/ XP Professional/ Server 2003, software and electronic manual on CD	6GK1 704-0AA07-3AA0 D)
SIMATIC NET S7-REDCONNECT/2005 (V6.3) Upgrade Runtime license without software, for expansion of S7-1613 to S7-REDCONNECT, in 2 languages (German, English), executes with Windows 2000 Professional/ 2000 Server/ XP Professional/ Server 2003, single license for 1 installation, license key on diskette; software and electronic manual available on separate SIMATIC NET CD Edition 2005	6GK1 716-0HB63-3AD0		

D) Subject to export regulations: AL: N, ECCN: 5D992B1

Update/upgrade packages

SIMATIC PDM upgrades

Overview

SIMATIC PDM can be integrated in the engineering system, i.e. in the configuration environment of SIMATIC PCS 7, or operated in stand-alone mode. Since the version cycle of SIMATIC PDM is different from that of SIMATIC PCS 7, the upgrade information is summarized here in a separate paragraph "Upgrades of SIMATIC PDM".

Selection and Ordering Data Order No.

SIMATIC PDM upgrade/update service

SIMATIC PDM Upgrade from V5.x to V6.0

for all product versions and combinations

5 languages (German, English, French, Spanish, Italian), executes with Windows 2000 Professional or Windows XP Professional, floating license for 1 user

Type of delivery:

License key disk, emergency key disk, certificate of license, terms and conditions; 2 CDs with SIMATIC PDM V6.0 and device library as well as supplementary DVD with Microsoft ServicePacks and tools

6ES7 651-5CX06-0YE5

SIMATIC PDM Software Update Service

Subscription for 1 year with automatic extension

Requirement: current software version

6ES7 658-3XX00-0YL8

Update/upgrade packages SIMATIC PCS 7 upgrades V6.x to V7.0

Upgrades for engineering system

Overview

SIMATIC PCS 7 engineering systems with Engineering Software V6.0 or V6.1 can be upgraded to Version 7.0 using the SIMATIC PCS 7 Engineering Upgrade Package.

It may also be necessary to upgrade the S7-REDCONNECT communications software from V6.3 (edition 2005) to V6.4 (edition 2006). S7-REDCONNECT is only required in combination with fault-tolerant automation systems.

Engineering Upgrade Package V6.x to V7.0

The licenses included in the Engineering Upgrade Package V6.x to V7.0 apply to the following software components of SIMATIC PCS 7 version 6.0/6.1:

- PCS 7 Engineering AS (all PO versions)
- PCS 7 Engineering OS (all PO versions)
- Version Cross Checker
- Version Trail
- Import/Export Assistant
- PCS 7 PID-Tuner
- SIMATIC Logon
- WinCC Redundancy
- SFC Visualization
- BCE License
- SIMATIC NET S7-1613 for Industrial Ethernet

Upgrade of S7-REDCONNECT communications software

If fault-tolerant automation systems are used, the engineering station requires the S7-REDCONNECT communications software in addition to the CP 1613 (A2) communications processor for the bus communication. This is available as:

- S7-REDCONNECT
- S7-REDCONNECT Upgrade (additive to existing S7-1613 communications software)

The SIMATIC NET S7-REDCONNECT V6.3 communications software is used in the engineering software with SIMATIC PCS 7 V6.x, on the other hand the SIMATIC NET S7-REDCONNECT V6.4 with SIMATIC PCS 7 V7.0. When upgrading the engineering station to SIMATIC PCS 7 V7.0, an upgrade of the S7-REDCONNECT communications software to V6.4 is therefore also required.

Upgrade of SIMATIC PDM

SIMATIC PDM can be integrated in the engineering system, i.e. in the configuration environment of SIMATIC PCS 7, or operated in stand-alone mode.

Since the version cycle of SIMATIC PDM is different from that of SIMATIC PCS 7, the upgrade information is summarized in a separate section "Upgrades of SIMATIC PDM" directly before this section.

Upgrade of S7-PLCSIM simulation software

S7-PLCSIM can be integrated in the engineering system, i.e. in the configuration environment of SIMATIC PCS 7. However, the version cycle of S7-PLCSIM is not always synchronous with the version cycle of SIMATIC PCS 7:

- SIMATIC PCS 7 V6.1 corresponds to S7-PLCSIM V5.3
- SIMATIC PCS 7 V7.0 + ServicePack 1 corresponds to the current program version S7-PLCSIM V5.4

Engineering software

Selection and Ordering Data Order No.

Upgrade of engineering software from V6.0/V6.1 to V7.0

SIMATIC PCS 7 Engineering Upgrade Package V6.x to V7.0 for AS/OS engineering

3 languages (German, English, French), executes with Windows XP Professional, floating license for 1 user

Type of delivery: License key disks, emergency key disk, certificate of license, terms and conditions; PCS 7 V7.0 toolset DVDs, Microsoft SQL Server 2005 including EULA and supplementary CDs/DVDs (e.g. Microsoft ServicePacks and tools)

6ES7 651-5AX07-0YE5

Communications software

Selection and Ordering Data Order No.

Upgrade of S7-REDCONNECT communications software from V6.3 (edition 2005) to V6.4 (edition 2006)

SIMATIC NET S7-REDCONNECT Upgrade from V6.3 to V6.4

Software for upgrading S7-REDCONNECT, runtime software, 2 languages (German, English), executes with Windows 2000 Professional/ 2000 Server/ XP Professional/ Server 2003, single license for 1 installation, software and electronic manual on CD-ROM, license key on diskette

6GK1 716-0HB64-3AE0

S7-PLCSIM simulation software

Selection and Ordering Data Order No.

S7-PLCSIM upgrade from V3.x, V4.x, V5.0, V5.2 or V5.3 to V5.4

5 languages (German, English, French, Italian, Spanish), executes with Windows 2000 Professional or Windows XP Professional, floating license for 1 user

Type of delivery: Authorization diskette, certificate of license, terms and conditions; software and electronic documentation on CD

6ES7 841-0CC05-0YE5

S7-PLCSIM Software Update Service

Subscription for 1 year with automatic extension; requirement: current software version

6ES7 841-0CA01-0YX2

Update/upgrade packages

SIMATIC PCS 7 upgrades V6.x to V7.0

Upgrades for operator system

Overview

Upgrades combined in packages permit upgrading of existing operator systems V6.0 or V6.1 to V7.0.

Upgrades of OS software

The upgrades for all PO versions of the OS software from V6.0/V6.1 to V7.0 are distributed between the following two OS upgrade packages:

SIMATIC PCS 7 OS Runtime Upgrade Package V6.0/V6.1 to V7.0

for OS single stations/OS servers (including archive servers), with:

- PCS 7 OS Software Single Station (all PO versions)
- PCS 7 OS Software Server (all PO versions as well as archives)
- SFC Visualization
- StoragePlus
- WinCC Redundancy
- SIMATIC Logon
- PCS 7 BCE
- SIMATIC NET S7-1613 for Industrial Ethernet

SIMATIC PCS 7 OS Client / SFC Visualization Upgrade Package V6.0/V6.1 to V7.0

for OS Clients, with:

- PCS 7 OS Software Client
- SFC Visualization
- SIMATIC Logon

Upgrade of S7-REDCONNECT communications software

If fault-tolerant automation systems are used, the OS single stations/OS servers require the S7-REDCONNECT communications software in addition to the CP 1613 (A2) communications processor for the bus communication. This is available as:

- S7-REDCONNECT
- S7-REDCONNECT Upgrade (additive to existing S7-1613 communications software)

The SIMATIC NET S7-REDCONNECT V6.3 communications software is used in OS single stations/OS servers with SIMATIC PCS 7 V6.x, on the other hand the SIMATIC NET S7-REDCONNECT V6.4 with SIMATIC PCS 7 V7.0. When upgrading the OS single stations/OS servers to SIMATIC PCS 7 V7.0, an upgrade of the S7-REDCONNECT communications software to V6.4 is therefore required.

Upgrade of OS long-term archiving

SIMATIC Upgrade StoragePlus V1.0/V1.1 to V1.2

Note:

The SIMATIC Upgrade StoragePlus V1.0/V1.1 to V1.2 is part of the SIMATIC PCS 7 OS Runtime Upgrade Package V6.0/V6.1 to V7.0

Central Archive Server (CAS) Upgrade V6.0/V6.1 to V7.0

Note:

The upgrade of the central archive server (CAS) based on the OS software server and additive OS Archive PowerPacks from V6.0/V6.1 to V7.0 is part of the SIMATIC PCS 7 OS Runtime Upgrade Package V6.0/V6.1 to V7.0

SIMATIC PCS 7 OS Web upgrade

Using the SIMATIC PCS 7 OS Web Server Upgrade Package, you can upgrade the SIMATIC PCS 7 Web server, SIMATIC PCS 7 Web diagnostics server and SIMATIC PCS 7 Web diagnostics clients from V6.1 to V7.0.

Update/upgrade packages SIMATIC PCS 7 upgrades V6.x to V7.0

Upgrades for operator system

OS software

Selection and Ordering Data	Order No.
Upgrades of OS software from V6.0/V6.1 to V7.0	
OS upgrade packages for upgrading all PO versions from V6.0/V6.1 to V7.0 SIMATIC PCS 7 OS Runtime Upgrade Package V6.0/V6.1 to V7.0 for OS single station, OS server and archive server, 5-languages (German, English, French, Italian, Spanish), executes with Windows XP Professional or Windows Server 2003, single license for 1 installation Type of delivery: License key disk, emergency key disk, certificate of license, terms and conditions; PCS 7 V7.0 toolset DVDs, Microsoft SQL Server 2005 including EULA and supplementary CDs/DVDs (e.g. Microsoft ServicePacks and tools)	6ES7 652-5AX07-0YE0
SIMATIC PCS 7 OS Client/SFC Visualization Upgrade Package V6.0/V6.1 to V7.0 5 languages (German, English, French, Italian, Spanish), executes with Windows XP Professional, floating license for 1 user Type of delivery: License key disk, emergency key disk, certificate of license, terms and conditions; PCS 7 V7.0 toolset DVDs, Microsoft SQL Server 2005 including EULA and supplementary CDs/DVDs (e.g. Microsoft ServicePacks and tools)	6ES7 652-5CX07-0YE5

Communications software

Selection and Ordering Data	Order No.
Upgrade of S7-REDCONNECT communications software from V6.3 (edition 2005) to V6.4 (edition 2006)	
SIMATIC NET S7-REDCONNECT Upgrade from V6.3 to V6.4 Software for upgrading S7-REDCONNECT, runtime software, 2 languages (German, English), executes with Windows 2000 Professional/ 2000 Server/ XP Professional/ Server 2003, single license for 1 installation, software and electronic manual on CD-ROM, license key on diskette	6GK1 716-0HB64-3AE0

OS long-term archiving

Selection and Ordering Data	Order No.
SIMATIC Upgrade StoragePlus V1.0/V1.1 to V1.2 Note: The SIMATIC Upgrade StoragePlus V1.1 to V1.2 is part of the SIMATIC PCS 7 OS Runtime Upgrade Package V6.0/V6.1 to V7.0	
Central Archive Server (CAS) Upgrade V6.0/V6.1 to V7.0 Note: The upgrade of the central archive server (CAS) from V6.0/V6.1 to V7.0 is part of the SIMATIC PCS 7 OS Runtime Upgrade Package V6.0/V6.1 to V7.0	

OS Web upgrade package

Selection and Ordering Data	Order No.
SIMATIC PCS 7 OS Web Server Upgrade Package V6.1 to V7.0 for SIMATIC PCS 7 Web server, SIMATIC PCS 7 Web diagnostics server, SIMATIC PCS 7 Web diagnostics client, 3 languages (German, English, French), executes with Windows Server 2003, single license for 1 installation Type of delivery: License key disk, emergency key disk, certificate of license, terms and conditions	6ES7 652-5DX07-0YF0

Update/upgrade packages

SIMATIC PCS 7 upgrades V6.x to V7.0

Upgrades for SIMATIC BATCH

Overview

SIMATIC BATCH packages for upgrading from V6.0/V6.1 to V7.0

The upgrades for all PO versions of the SIMATIC BATCH software from V6.0/V6.1 to V7.0 are distributed between the following two SIMATIC BATCH upgrade packages:

SIMATIC BATCH Client upgrade package

The SIMATIC BATCH Client upgrade package contains upgrade licenses for:

- SIMATIC BATCH Recipe System
- SIMATIC BATCH Batch Planning
- SIMATIC BATCH BatchCC
- SIMATIC Logon

SIMATIC BATCH Server upgrade package

The SIMATIC BATCH Server upgrade package contains upgrade licenses for:

- SIMATIC BATCH Server Basic Package (including all PO options and PowerPacks)
- SIMATIC BATCH Hierarchical Recipe
- SIMATIC BATCH ROP Library
- SIMATIC BATCH Separation Procedures/Formulas
- SIMATIC BATCH API
- SIMATIC Logon

Selection and Ordering Data

Order No.

SIMATIC BATCH Client Upgrade Package V6.0/V6.1 to V7.0

3 languages (German, English, French), executes with Windows XP Professional or Windows Server 2003, floating license for 1 user

Type of delivery:
License key disk, certificate of license, terms and conditions

6ES7 657-5XX07-0YF5

SIMATIC BATCH Server Upgrade Package V6.0/V6.1 to V7.0

3 languages (German, English, French), executes with Windows XP Professional or Windows Server 2003, single license for 1 installation

Type of delivery:
License key disk, certificate of license, terms and conditions

6ES7 657-5XX07-0YF0

Update/upgrade packages

SIMATIC PCS 7 upgrades V6.x to V7.0

Upgrades for SIMATIC Route Control

Overview

SIMATIC Route Control upgrade package

The SIMATIC Route Control upgrade package comprises all components for upgrading the Route Control Engineering, Route Control Server and Route Control Client software from V6.0/V6.1 to V7.0. Also involved are SIMATIC Logon, the BCE license PCS 7 BCE and SIMATIC NET S7-1613 for Industrial Ethernet.

Upgrade of S7-REDCONNECT communications software

If fault-tolerant automation systems are used together with SIMATIC Route Control, the RC single stations/RC servers require the S7-REDCONNECT communications software in addition to the CP 1613 (A2) communications processor for the bus communication. This is available as:

- S7-REDCONNECT
- S7-REDCONNECT Upgrade (additive to existing S7-1613 communications software)

The SIMATIC NET S7-REDCONNECT V6.3 communications software is used in OS single stations/OS servers with SIMATIC PCS 7 V6.x, on the other hand the SIMATIC NET S7-REDCONNECT V6.4 with SIMATIC PCS 7 V7.0. When upgrading the OS single stations/OS servers to SIMATIC PCS 7 V7.0, an upgrade of the S7-REDCONNECT communications software to V6.4 is therefore required.

Selection and Ordering Data Order No.

SIMATIC Route Control upgrade packages

SIMATIC Route Control Upgrade Package V6.0/V6.1 to V7.0

for Route Control Engineering, Route Control Server and Route Control Center, suitable for single station and client/server configuration

3 languages (German, English, French), executes with Windows XP Professional or Windows Server 2003, single license for 1 installation

Type of delivery: License key disk, emergency key disk, certificate of license, terms and conditions

6ES7 652-5BX07-0YF0

Software Update Service

SIMATIC Route Control

See Section "Software Update Service"

Communications software

Selection and Ordering Data Order No.

Upgrade of S7-REDCONNECT communications software from V6.3 (edition 2005) to V6.4 (edition 2006)

SIMATIC NET S7-REDCONNECT Upgrade from V6.3 to V6.4

Software for upgrading S7-REDCONNECT, runtime software, 2 languages (German, English), executes with Windows 2000 Professional/ 2000 Server/ XP Professional/ Server 2003, single license for 1 installation, software and electronic manual on CD-ROM, license key on diskette

6GK1 716-0HB64-3AE0

Update/upgrade packages

SIMATIC PCS 7 upgrades V6.x to V7.0

Upgrades for Asset Management

Overview

SIMATIC PCS 7 Asset upgrade

With the SIMATIC PCS 7 Asset upgrade package you can upgrade SIMATIC PCS 7 Asset Engineering as well as all TAG versions of SIMATIC PCS 7 Asset Runtime from V6.1 to V7.0. The SNMP OPC server license is also involved.

Selection and Ordering Data

Order No.

SIMATIC PCS 7 Asset upgrade

SIMATIC PCS 7 Asset Upgrade Package V6.1 to V7.0

for Asset Engineering and Asset Runtime, 3 languages (German, English, French), executes with Windows XP Professional or Windows Server 2003, single license for 1 installation

Type of delivery:
License key disk, certificate of license, terms and conditions

6ES7 652-5FX07-0YF0

Update/upgrade packages

SIMATIC PCS 7 upgrades V4.02 to V6.1

SIMATIC PCS 7 upgrades V5.x/V6.0 to V6.1

Overview

This section provides an overview of the upgrade packages with which existing systems based on SIMATIC PCS 7 V5.x or V6.0 can be upgraded to V6.1. The upgrade packages are grouped as follows:

- Engineering system
- Operator system
- SIMATIC BATCH
- SIMATIC Route Control

Engineering system

Selection and Ordering Data Order No.

Upgrade of engineering software from V6.0 to V6.1

PCS 7 AS/OS Engineering Upgrade Package for AS/OS upgrade from V6.0 to V6.1

6ES7 651-5AX16-0YE5

3 languages (German, English, French), executes with Windows 2000 Professional/ 2000 Server or Windows XP Professional/ Server 2003, floating license for 1 user

Type of delivery:
License key disk, emergency key disk, certificate of license, terms and conditions;
PCS 7 V6.1 toolset DVD, Microsoft SQL Server including EULA, PC Anywhere Host and supplementary CDs/DVDs (e.g. Microsoft ServicePacks and tools)

Upgrade of SIMATIC Version Cross Checker from V6.0 to V6.1

The Version Cross Checker upgrade is included in the PCS 7 AS/OS Engineering Upgrade Package V6.0 to V6.1 (see above)

Selection and Ordering Data Order No.

Upgrades of engineering software from V5.x to V6.1

Upgrade PCS 7 Starter Package from V5.x to V6.1

3 languages (German, English, French), executes with Windows 2000 Professional/ 2000 Server or Windows XP Professional/ Server 2003, floating license for 1 user

Type of delivery:
License key disk, emergency key disk, certificate of license, terms and conditions;
PCS 7 V6.1 toolset DVD, Microsoft SQL Server including EULA, PC Anywhere Host and supplementary CDs/DVDs (e.g. Microsoft ServicePacks and tools)

- AS/OS upgrade for 250 POs/ RC 8K

6ES7 658-5AA16-0YE5

Upgrade AS Software Engineering from V5.x to V6.1

3 languages (German, English, French), executes with Windows 2000 Server or Windows Server 2003, single license for 1 installation

Type of delivery:
License key disk, emergency key disk, certificate of license, terms and conditions;
PCS 7 V6.1 toolset DVD, Microsoft SQL Server including EULA, PC Anywhere Host and supplementary CDs/DVDs (e.g. Microsoft ServicePacks and tools)

- AS upgrade for 3000 POs
- AS upgrade for unlimited POs

6ES7 658-1AD16-0YE5

6ES7 658-1AF16-0YE5

Upgrade OS Software Engineering from V5.x to V6.1

3 languages (German, English, French), executes with Windows 2000 Server or Windows Server 2003, single license for 1 installation

Type of delivery:
License key disk, emergency key disk, certificate of license, terms and conditions;
PCS 7 V6.1 toolset DVD, Microsoft SQL Server including EULA, PC Anywhere Host and supplementary CDs/DVDs (e.g. Microsoft ServicePacks and tools)

- OS upgrade for 2000 POs/ RC 64K
- OS upgrade for 5000 POs/ RC 150K

6ES7 658-2DC16-0YE5

6ES7 658-2DE16-0YE5

Update/upgrade packages

SIMATIC PCS 7 upgrades V4.02 to V6.1

SIMATIC PCS 7 upgrades V5.x/V6.0 to V6.1

Operator system

Selection and Ordering Data

Order No.

Upgrades of OS software from V6.0 to V6.1

OS upgrade packages for upgrading all PO versions from V6.0 to V6.1

- **SIMATIC PCS 7 Upgrade Package Runtime OS V6.0 to V6.1** for OS single station, OS server and archive server, 3 languages (German, English, French), executes with Windows 2000 Professional / 2000 Server or Windows XP Professional / Server 2003, single license for 1 installation

6ES7 652-5AX16-0YE0

Type of delivery:
License key disk, emergency key disk, certificate of license, terms and conditions;
PCS 7 V6.1 toolset DVD, Microsoft SQL Server including EULA, PC Anywhere Host and supplementary CDs/DVDs (e.g. Microsoft ServicePacks and tools)

- **SIMATIC PCS 7 Upgrade Package OS Client/SFC Visualization V6.0 to V6.1** 3 languages (German, English, French), executes with Windows 2000 Professional or Windows XP Professional, floating license for 1 user

6ES7 652-5CX16-0YE5

Type of delivery:
License key disk, emergency key disk, certificate of license, terms and conditions;
PCS 7 V6.1 toolset DVD, Microsoft SQL server including EULA, PC Anywhere Host and supplementary CDs/DVDs (e.g. Microsoft ServicePacks and tools)

Upgrades of OS software from V5.x to V6.1

SIMATIC PCS 7 Upgrade OS Software Single Station V5.x to V6.1

3 languages (German, English, French), executes with Windows 2000 Professional or Windows XP Professional, single license for 1 installation

Type of delivery:
License key disk, emergency key disk, certificate of license, terms and conditions;
PCS 7 V6.1 toolset DVD, Microsoft SQL Server including EULA, PC Anywhere Host and supplementary CDs/DVDs (e.g. Microsoft ServicePacks and tools)

- 2000 POs/RT 64K¹⁾
- 5000 POs/RT 150K¹⁾

6ES7 658-2AC16-0YE0

6ES7 658-2AE16-0YE0

Selection and Ordering Data

Order No.

SIMATIC PCS 7 Upgrade OS Software Server V5.x to V6.1

3 languages (German, English, French), executes with Windows 2000 Server or Windows Server 2003, single license for 1 installation

Type of delivery:
License key disk, emergency key disk, certificate of license, terms and conditions;
PCS 7 V6.1 toolset DVD, Microsoft SQL Server including EULA, PC Anywhere Host and supplementary CDs/DVDs (e.g. Microsoft ServicePacks and tools)

- 2000 POs/RT 64K¹⁾
- 5000 POs/RT 150K¹⁾

6ES7 658-2BC16-0YE0

6ES7 658-2BE16-0YE0

SIMATIC PCS 7 Upgrade OS Software Client V5.x to V6.1

3 languages (German, English, French), executes with Windows 2000 Professional or Windows XP Professional, floating license for 1 user

Type of delivery:
License key disk, emergency key disk, certificate of license, terms and conditions;
PCS 7 V6.1 toolset DVD, Microsoft SQL Server including EULA, PC Anywhere Host and supplementary CDs/DVDs (e.g. Microsoft ServicePacks and tools)

6ES7 658-2CX16-0YE5

Upgrade of SFC Visualization

SIMATIC PCS 7 Upgrade SFC Visualization V5.x to V6.1

3 languages (German, English, French), executes with Windows 2000 Professional or Windows XP Professional, floating license for 1 user

Type of delivery:
License key disk, emergency key disk, certificate of license, terms and conditions

6ES7 652-0XD16-2YF5

Upgrade of SIMATIC StoragePlus

SIMATIC Upgrade StoragePlus V1.0 to V1.1

Type of delivery:
License key disk, emergency key disk, certificate of license, terms and conditions

6ES7 652-0XC11-2YF0

¹⁾ The OS Software Single Station and OS Software Server upgrades support a high-performance archive system for up to 512 variables. To implement larger archives, this volume can be extended using additive OS Archive V6.1 PowerPacks/bundles (see OS archiving).

Update/upgrade packages

SIMATIC PCS 7 upgrades V4.02 to V6.1

SIMATIC PCS 7 upgrades V5.x/V6.0 to V6.1

SIMATIC BATCH

Selection and Ordering Data	Order No.
SIMATIC BATCH Upgrade from BATCH flexible V4.02 to SIMATIC BATCH V6.1 3 languages (German, English, French), executes with Windows 2000 Professional/ 2000 Server or Windows XP Professional/ Server 2003, floating license for 1 user Type of delivery: License key disk, certificate of license, terms and conditions	6ES7 657-0XX16-0YF0
SIMATIC BATCH Upgrade Package BATCH Client from V6.0 to V6.1 3 languages (German, English, French), executes with Windows 2000 Professional/ 2000 Server or Windows XP Professional/ Server 2003, floating license for 1 user Type of delivery: License key disk, certificate of license, terms and conditions	6ES7 657-5XX16-0YF5
SIMATIC BATCH Upgrade Package BATCH Server from V6.0 to V6.1 3 languages (German, English, French), executes with Windows 2000 Professional/ 2000 Server or Windows XP Professional/ Server 2003, single license for 1 installation Type of delivery: License key disk, certificate of license, terms and conditions	6ES7 657-5XX16-0YF0

SIMATIC Route Control upgrade packages

Selection and Ordering Data	Order No.
SIMATIC Route Control Runtime Upgrade Package V6.0 to V6.1 For single station and client/server configuration 3 languages (German, English, French), executes with Windows 2000 Server or Windows Server 2003, single license for 1 installation Type of delivery: License key disk, emergency key disk, certificate of license, terms and conditions	6ES7 652-5BX16-0YF0
SIMATIC Route Control Center Upgrade V6.0 to V6.1 3 languages (German, English, French), executes with Windows 2000 Professional or Windows XP Professional, floating license for 1 user Type of delivery: License key disk, emergency key disk, certificate of license, terms and conditions	6ES7 658-7EX16-0YF5
SIMATIC Route Control Engineering Upgrade V6.0 to V6.1 3 languages (German, English, French), executes with Windows 2000 Professional/ 2000 Server or Windows XP Professional/ Server 2003, floating license for 1 user Type of delivery: License key disk, certificate of license, terms and conditions	6ES7 658-7DX16-0YF5

Update/upgrade packages

SIMATIC PCS 7 upgrades V4.02 to V6.1

SIMATIC PCS 7 upgrades V4.02 to V5.2

Overview

This section summarizes the upgrade software which is required to upgrade the engineering station and operator stations of the SIMATIC PCS 7 process control system from V4.02 to V5.2.

Engineering system

Selection and Ordering Data Order No.

Engineering software upgrade for AS engineering

PCS 7 Engineering Toolset Upgrade V4.02 to V5.2

for max. 3000 process objects, executes with Windows NT 4.0 Workstation

Type of delivery:

- CD with the components: STEP 7, CFC, SFC, S7-SCL, Technological Hierarchy, Import/Export Assistant, DOCPRO and I&C Library
- Software licenses on authorization diskette

6ES7 658-1AB05-0YC4

Engineering software upgrade for OS engineering

If the engineering station is used for OS engineering, you require an OS Software Upgrade from V4.02 to V5.02 for the OS engineering software package.

Operator system

Selection and Ordering Data Order No.

OS software upgrade

PCS 7 OS Software Upgrade V4.02 to V5.2

for OS Software Single Station, OS Software Server, OS Software Terminal and OS Software Engineering (1 upgrade package required for each), executes with Windows NT 4.0 Workstation

Type of delivery:

- CD with OS I&C software
- BCE license and software licenses on authorization diskette

6ES7 658-2XB05-0YC4

Appendix

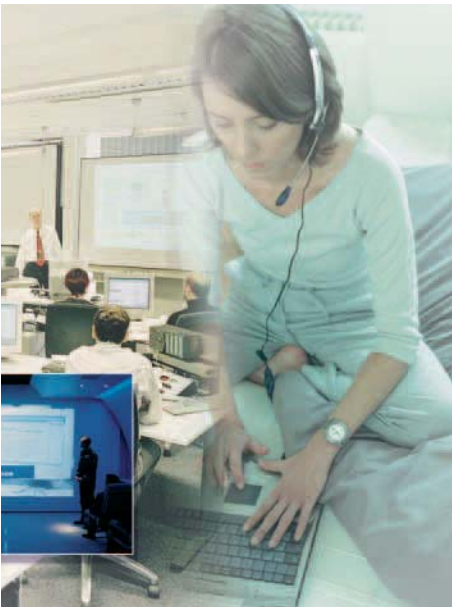

16/2	Training
16/3	Siemens Contacts Worldwide
16/4	A&D Online Services
16/5	Customer Support
16/7	Siemens Solution Partner Automation and Power Distribution
16/8	Software Licenses
16/9	Subject index
16/11	Order no. index
16/16	Conditions of sale and delivery Export regulations

Training

Faster and more applicable know-how: Hands-on training from the manufacturer

SITRAIN® – the Siemens Training for Automation and Industrial Solutions – provides you with comprehensive support in solving your tasks.

Training by the market leader in automation and plant engineering enables you to make independent decisions with confidence. Especially where the optimum and efficient use of products and plants are concerned. You can eliminate deficiencies in existing plants, and exclude expensive faulty planning right from the beginning.



First-class know-how directly pays for itself: In shorter start-up times, high-quality end products, faster troubleshooting and reduced downtimes. In other words, increased profits and lower costs.

Achieve more with SITRAIN

- Shorter times for startup, maintenance and servicing
- Optimized production operations
- Reliable configuration and startup
- Minimization of plant downtimes
- Flexible plant adaptation to market requirements
- Compliance with quality standards in production
- Increased employee satisfaction and motivation
- Shorter familiarization times following changes in technology and staff

Contact

Visit our site on the Internet at:

www.siemens.com/sitrain

or let us advise you personally. You can request our latest training catalog from:

SITRAIN Customer Support Germany:

Phone: +49 (0)1805 / 23 56 11
(0.14 €/min from the German landline network)

Fax: +49 (0)1805 / 23 56 12

SITRAIN highlights

Top trainers

Our trainers are skilled teachers with direct practical experience. Course developers have close contact with product development, and directly pass on their knowledge to the trainers.

Practical experience

The practical experience of our trainers enables them to teach theory effectively. But since theory can be pretty drab, we attach great importance to practical exercises which can comprise up to half of the course time. You can therefore immediately implement your new knowledge in practice. We train you on state-of-the-art methodically/didactically designed training equipment. This training approach will give you all the confidence you need.

Wide variety

With a total of about 300 local attendance courses, we train the complete range of A&D products as well as interaction of the products in systems. Telecourses, teach-yourself software and seminars with a presenter on the Web supplement our classic range of courses.

Tailor-made training

We are only a short distance away. You can find us at more than 50 locations in Germany, and in 62 countries worldwide. You wish to have individual training instead of one of our 300 courses? Our solution: We will provide a program tailored exactly to your personal requirements. Training can be carried out in our Training Centers or at your company.

The right mixture: Blended learning

"Blended learning" means a combination of various training media and sequences. For example, a local attendance course in a Training Center can be optimally supplemented by a teach-yourself program as preparation or follow-up. Additional effect: Reduced traveling costs and periods of absence.



Appendix

Siemens Contacts Worldwide

SIEMENS Find (Home | Personalization | About us | English)

Local Partners Worldwide

Germany

Are you looking for a local contact to help you with questions regarding Siemens Automation and Drives products, solutions and services?

O.K. First, please select the city nearest to your location:

(or to select a different country click here)

Berlin

Now select the appropriate team who you would like to deal with your enquiry:

Sales

Next >

Contact

© 2003 Siemens, Automation and Drives
personal terms of use and editorial

Webmaster

SIEMENS Find (Home | Personalization | About us | English)

Local Partners Worldwide

Please select a sector

Select area/sector | Select city | Your contact(s)

Sectors | Search a Sector

Which sector* is your question regarding?

ADD Sectors

- Video Systems, Visualization Systems
- Electrical Wholesaler
- Material Flow Controlling, Distribution and Logistics
- Assembly Control
- Paper Machines
- Production Automation in the Automotive Industry and Suppliers
- Production Logistics and Control Systems
- Production Machines, Textiles, Plastics, Metal Forming, Wood, Glass, Ceramic processing, Stone processing, Packaging, Printing, Cranes
- Process Control Systems
- Testing/Fine Assembly

* This list contains industry sectors covered by Siemens Automation and Drives products and solutions.

Please select the team who you would like to deal with your enquiry:

Sales

Next >

Contact

© 2003 Siemens, Automation and Drives
personal terms of use and editorial

Webmaster

SIEMENS Find (Home | Personalization | About us | English)

Local Partners Worldwide

Please select a Siemens product group

Select area/product | Select city | Your contact(s)

Product Catalog | Search a Product

Which product* does your question refer to?

ADD Product Catalog

- Drive Technology
- Automation systems
- Communication Networks
- Low-Voltage Control
- Electrical Installation Technology
- Process Automation
- Sensor, measuring and testing technology
- Power supplies
- Safety systems - Safety Integrated
- System solutions sector products for branches

* This list contains products and solutions provided by Siemens Automation and Drives

Please select the team who you would like to deal with your enquiry:

Sales

Next >

Contact

© 2003 Siemens, Automation and Drives
personal terms of use and editorial

Webmaster

At

<http://www.siemens.com/automation/partner>

you can find details of Siemens contact partners worldwide responsible for particular technologies.

You can obtain in most cases a contact partner for

- Technical Support,
- Spare parts/repairs,
- Service,
- Training,
- Sales or
- Consultation/engineering.

You start by selecting a

- Country,
- Product or
- Sector.

By further specifying the remaining criteria you will find exactly the right contact partner with his/her respective expertise.

Appendix A&D Online Services

Information and Ordering in the Internet and on CD-ROM

A&D in the WWW



A detailed knowledge of the range of products and services available is essential when planning and configuring automation systems. It goes without saying that this information must always be fully up-to-date.

The Siemens Automation and Drives Group (A&D) has therefore built up a comprehensive range of information in the World Wide Web, which offers quick and easy access to all data required.

Under the address

<http://www.siemens.com/automation>

you will find everything you need to know about products, systems and services.

Product Selection Using the Offline Mall of Automation and Drives

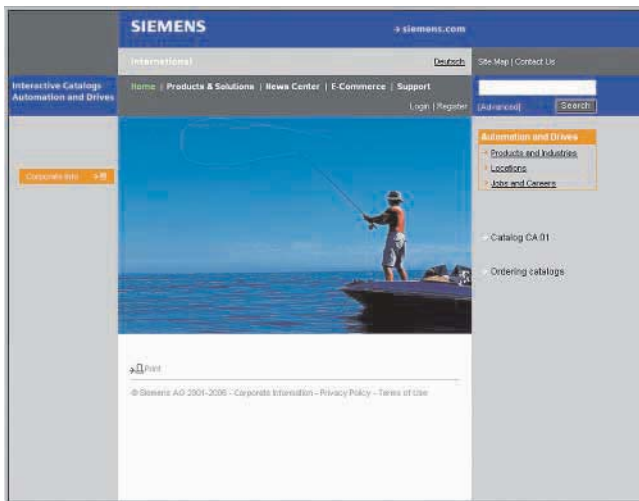

Detailed information together with convenient interactive functions:

The Offline Mall CA 01 covers more than 80,000 products and thus provides a full summary of the Siemens Automation and Drives product base.

Here you will find everything that you need to solve tasks in the fields of automation, switchgear, installation and drives.

All information is linked into a user interface which is easy to work with and intuitive.

After selecting the product of your choice you can order at the press of a button, by fax or by online link.

Information on the Offline Mall CA 01 can be found in the Internet under

<http://www.siemens.com/automation/ca01>

or on CD-ROM or DVD.

Easy Shopping with the A&D Mall



The A&D Mall is the virtual department store of Siemens AG in the Internet. Here you have access to a huge range of products presented in electronic catalogs in an informative and attractive way.

Data transfer via EDIFACT allows the whole procedure from selection through ordering to tracking of the order to be carried out online via the Internet.

Numerous functions are available to support you.

For example, powerful search functions make it easy to find the required products, which can be immediately checked for availability. Customer-specific discounts and preparation of quotes can be carried out online as well as order tracking and tracing.

Please visit the A&D Mall on the Internet under:

<http://www.siemens.com/automation/mall>

Our Services for Every Phase of Your Project



In the face of harsh competition you need optimum conditions to keep ahead all the time:

A strong starting position. A sophisticated strategy and team for the necessary support - in every phase.

Service & Support from Siemens provides this support with a complete range of different services for automation and drives.

In every phase: from planning and startup to maintenance and upgrading.

Our specialists know when and where to act to keep the productivity and cost-effectiveness of your system running in top form.

Configuration and Software Engineering



Support in configuring and developing with customer-oriented services from actual configuration to implementation of the automation project.¹⁾

Service On Site



With Service On Site we offer services for startup and maintenance, essential for ensuring system availability.

In Germany
0180 50 50 444¹⁾
 (0.14 €/min from the German fixed network)

Online Support



The comprehensive information system available round the clock via Internet ranging from Product Support and Service & Support services to Support Tools in the Shop.

<http://www.siemens.com/automation/service&support>

Repairs and Spare Parts



In the operating phase of a machine or automation system we provide a comprehensive repair and spare parts service ensuring the highest degree of operating safety and reliability.

In Germany
0180 50 50 446¹⁾
 (0.14 €/min from the German fixed network)

Technical Support



Competent consulting in technical questions covering a wide range of customer-oriented services for all our products and systems.

Tel.: +49 (0)180 50 50 222
Fax: +49 (0)180 50 50 223
 (0.14 €/min from the German fixed network)

<http://www.siemens.com/automation/support-request>

Technical Consulting



Support in the planning and designing of your project from detailed actual-state analysis, target definition and consulting on product and system questions right to the creation of the automation solution.¹⁾

Optimization and Upgrading



To enhance productivity and save costs in your project we offer high-quality services in optimization and upgrading.¹⁾

¹⁾ For country-specific telephone numbers go to our Internet site at: <http://www.siemens.com/automation/service&support>

Appendix

Customer Support

Knowledge Base on CD-ROM



For locations without online connections to the Internet there are excerpts of the free part of the information sources available on CD-ROM (Service & Support Knowledge Base). This CD-ROM contains all the latest product information at the time of production (FAQs, Downloads, Tips and Tricks, Updates) as well as general information on Service and Technical Support.

The CD-ROM also includes a full-text search and our Knowl-

edge Manager for targeted searches for solutions. The CD-ROM will be updated every 4 months.

Just the same as our online offer in the Internet, the Service & Support Knowledge Base on CD comes complete in 5 languages (German, English, French, Italian, Spanish).

You can order the **Service & Support Knowledge Base** CD from your Siemens contact.

Order no. **6ZB5310-0EP30-0BA2**

Orders via the Internet (with Automation Value Card or credit card) at:

<http://www.siemens.com/automation/service&support>

in the Shop domain.

Automation Value Card



Small card - great support

The Automation Value Card is an integral component of the comprehensive service concept with which Siemens Automation and Drives will accompany you in each phase of your automation project.

It doesn't matter whether you want just specific services from our Technical Support or want to purchase high-quality Support Tools in our Online Shop, you can always pay with your Automation Value Card. No invoicing, transparent and safe. With your personal card number and associated PIN you can view the state of your account and all transactions at any time.

Services on card. This is how it's done.

Card number and PIN are on the back of the Automation Value Card. When delivered, the PIN is covered by a scratch field, guaranteeing that the full credit is on the card.

By entering the card number and PIN you have full access to the Service & Support services being offered. The charge for the services procured is debited from the credits on your Automation Value Card.

All the services offered are marked in currency-neutral credits, so you can use the Automation Value Card worldwide.

Automation Value Card order numbers

Credits	Order no.
200	6ES7 997-0BA00-0XA0
500	6ES7 997-0BB00-0XA0
1000	6ES7 997-0BC00-0XA0
10000	6ES7 997-0BG00-0XA0

Detailed information on the services offered is available on our Internet site at:

<http://www.siemens.com/automation/service&support>

Service & Support à la Card: Examples

Technical Support

"Priority"	Priority processing for urgent cases
"24 h"	Availability round the clock
„Extended“	Technical consulting for complex questions

Support Tools in the Support Shop

"System Utilities"	Tools that can be used directly for configuration, analysis and testing
"Applications"	Complete topic solutions including ready-tested software
"Functions & Samples"	Adaptable blocks for accelerating your developments

Overview

Solution Partner Automation	SIEMENS
Solution Partner Power Distribution	SIEMENS

Products and systems from Siemens Automation and Drives provide the ideal platform for all automation tasks.

Siemens Solution Partners offer customized future-proof solutions with products and systems from Siemens Automation and Drives. The basis: qualified product and system knowledge coupled with a high degree of solutions and industry-related expertise.

In the Siemens Solution Partner Program you are certain to find the optimum partner for your specific requirements. Since more than 570 companies worldwide belong to the program, you can be sure to get expert support at your location.

The Solution Partner Finder, available to you on the Internet, is a comprehensive database in which all Solution Partners, together with their performance profiles, present themselves.

In addition to the search criteria Technology, Sector and Country, you can also search by Company and ZIP Code. From there it is only a small step to making the first contact.

Call up the Solution Partner Finder as follows:

- CA 01 on CD-ROM:
On the start page via "Contacts & Partners; Siemens Solution Partner Automation and Power Distribution"
- CA 01 online:
Go directly to the Solution Partner Finder:
www.siemens.com/automation/partnerfinder

Additional information about the Siemens Solution Partner Program is available in the Internet at:

www.siemens.com/automation/solutionpartner

Software Licenses

Overview

Software types

Software requiring a license is categorized into types. The following software types have been defined:

- Engineering software
- Runtime software

Engineering software

This includes all software products for creating (engineering) user software, e.g. for configuring, programming, parameterizing, testing, commissioning or servicing.

Data generated with engineering software and executable programs can be duplicated for your own use or for use by third-parties free-of-charge.

Runtime software

This includes all software products required for plant/machine operation, e.g. operating system, basic system, system expansions, drivers, etc.

The duplication of the runtime software and executable programs created with the runtime software for your own use or for use by third-parties is subject to a charge.

You can find information about license fees according to use in the ordering data (e.g. in the catalog). Examples of categories of use include per CPU, per installation, per channel, per instance, per axis, per control loop, per variable, etc.

Information about extended rights of use for parameterization/configuration tools supplied as integral components of the scope of delivery can be found in the readme file supplied with the relevant product(s).

License types

Siemens Automation & Drives offers various types of software license:

- Floating license
- Single license
- Rental license
- Trial license

Floating license

The software may be installed for internal use on any number of devices by the licensee. Only the concurrent user is licensed. The concurrent user is the person using the program. Use begins when the software is started.

A license is required for each concurrent user.

Single license

Unlike the floating license, a single license permits only one installation of the software.

The type of use licensed is specified in the ordering data and in the Certificate of License (CoL). Types of use include for example per device, per axis, per channel, etc.

One single license is required for each type of use defined.

Rental license

A rental license supports the "sporadic use" of engineering software. Once the license key has been installed, the software can be used for a specific number of hours (the operating hours do not have to be consecutive).

One license is required for each installation of the software.

Trial license

A trial license supports "short-term use" of the software in a non-productive context, e.g. for testing and evaluation purposes. It can be transferred to another license.

Factory license

With the Factory License the user has the right to install and use the software at one permanent establishment only. The permanent establishment is defined by one address only. The number of hardware devices on which the software may be installed results from the order data or the Certificate of License (CoL).

Certificate of license

The Certificate of License (CoL) is the licensee's proof that the use of the software has been licensed by Siemens. A CoL is required for every type of use and must be kept in a safe place.

Downgrading

The licensee is permitted to use the software or an earlier version/release of the software, provided that the licensee owns such a version/release and its use is technically feasible.

Delivery versions

Software is constantly being updated. The following delivery versions

- PowerPack
- Upgrade

can be used to access updates.

Existing bug fixes are supplied with the ServicePack version.

PowerPack

PowerPacks can be used to upgrade to more powerful software. The licensee receives a new license agreement and CoL (Certificate of License) with the PowerPack. This CoL, together with the CoL for the original product, proves that the new software is licensed.

A separate PowerPack must be purchased for each original license of the software to be replaced.

Upgrade

An upgrade permits the use of a new version of the software on the condition that a license for a previous version of the product is already held.

The licensee receives a new license agreement and CoL with the upgrade. This CoL, together with the CoL for the previous product, proves that the new version is licensed.

A separate upgrade must be purchased for each original license of the software to be upgraded.

ServicePack

ServicePacks are used to debug existing products.

ServicePacks may be duplicated for use as prescribed according to the number of existing original licenses.

License key

Siemens Automation & Drives supplies software products with and without license keys.

The license key serves as an electronic license stamp and is also the "switch" for activating the software (floating license, rental license, etc.).

The complete installation of software products requiring license keys includes the program to be licensed (the software) and the license key (which represents the license).



Detailed explanations concerning license conditions can be found in the "Terms and Conditions of Siemens AG" or under <http://www.siemens.com/automation/mall> (A&D Mall Online-Help System)

A&D/Software licenses/En 03.08.06

- A**
- Access Point 9/31
 - Active Field Distributor 9/49
 - Administration 2/3
 - Advanced Process Control (APC) functions..... 4/8
 - Alarms 5/10
 - Archive Server..... 5/23
 - AS-Interface 9/51
 - Asset Management 8/2
 - Automation systems..... 10/2
- B**
- Batch automation 6/2
 - Batch Control Center 6/8
 - Batch Planning..... 6/10
 - Branch & Merge..... 4/6
- C**
- Cable duct 11/12
 - Central Archive Server 5/23
 - Central I/O..... 11/4
 - Chipcard reader..... 2/5
 - Clock synchronization..... 5/11
 - Closed-loop control modules..... 11/27
 - Component view 4/6
 - Concurrent Engineering 4/6
 - Configurator 2/18
 - ConPerMon 4/8
 - Continuous Function Chart (CFC)..... 4/7
 - Counter modules..... 11/29
 - CP 1613 9/28
 - CP 443-5 Extended 9/41
- D**
- DOCPRO..... 4/9
 - DP/PA link and DP/PA coupler 9/45
 - Dummy module..... 11/12
- E**
- Electrical Switch Modules ESM..... 9/21
 - Electronic Device Description..... 4/17
 - Electronic Signature 2/3
 - Engineering F/FH systems 4/22
 - Engineering system 4/2
 - ES software 4/4
 - ET 200iSP..... 11/30
 - ET 200M 11/9
 - ET 200pro..... 11/56
 - ET 200S..... 11/39
 - Ex modules 11/22
 - Ex partition 11/12
 - Expansion units..... 11/5
- F**
- F modules 11/25
 - Faceplate Designer 4/9
 - FastConnect 9/23
 - FastConnect/SplitConnect..... 9/50
 - Fault-tolerant automation systems..... 10/15
 - Fiber-optic cables..... 9/26
- G**
- Glas fiber-optic cables 9/39
 - Graphics Designer 4/9
- H**
- HART 11/23
 - Hazardous area 11/2
 - Hierarchical Recipe 6/11
- I**
- I&C libraries..... 4/8
 - I/O subsystem for ET 200M 11/13
 - IF 964-DP..... 9/41
 - Import/Export Assistant 4/12
 - Industrial Ethernet 9/3
 - Industrial Ethernet Switches 9/6
 - Industrial Security 9/33
 - Industrial Wireless LAN 9/30
 - Industrial Workstation 2/6
 - Interface module 11/11
 - ITP cables and connectors 9/25
- K**
- Keyboards 2/15
- L**
- Libraries..... 4/8
 - Long-term archiving 5/21
- M**
- Maintenance station 8/4
 - Media converter 9/21
 - Messages 5/10
 - Microbox automation system..... 10/4
 - Microsoft SQL Server..... 4/4
 - Migration..... 13/2
 - Modbus 9/52
 - Motor starters 11/49
 - MTA..... 11/6
 - Multi project engineering..... 4/6
 - Multi-VGA graphics cards 2/16
 - Multi-VGA operation 2/6
- O**
- OpenPCS 7 5/27
 - Operating system..... 2/6
 - Operator system 5/2
 - Optical Switch Modules OSM 9/21
 - OS archiving 5/19
 - OS hardware 5/4
 - OS redundancy..... 5/16
 - OS software..... 5/12
 - OS variables..... 5/3
 - OS-LAN 9/4
- P**
- PID-Tuner 4/8
 - Plant bus 9/4
 - Plastic fiber-optic cables..... 9/40
 - Power supply cable for Rack PC 2/15
 - Process Device Manager..... 4/13
 - Process I/O 11/2
 - Process monitors 2/17
 - Process object 5/3
 - Process object view 4/6
 - PROFIBUS..... 9/35
 - PROFIBUS DP..... 9/36
 - PROFIBUS PA 9/43
 - Programming Instructions Driver Blocks..... 2/2
- R**
- Recipe system 6/9
 - ROP Library 6/12
 - Route Control 7/2
 - Route Control Center 7/6
 - Route Control Server 7/6
 - Routing..... 4/16
 - Runtime Basic Packages..... 3/13

Appendix

Subject index

S

S5 Manual Collection 2/2
 S7 F ConfigurationPack 4/22
 S7 Manual Collection 2/2
 S7-PLCSIM 4/26
 S7-REDCONNECT 9/29
 Safety ES Packages 4/25
 Safety Matrix 4/23
 Safety Matrix Viewer 5/15
 Safety-related automation systems 10/24
 Scalability 1/11
 SCALANCE S 9/34
 SCALANCE X 9/6
 Script languages 5/11
 Separation Procedures/Formulas 6/12
 Sequential Function Chart (SFC) 4/7
 Server Basic Package 6/7
 SFC Visualization 5/14
 Short-term archiving 5/20
 Signal module 5/8
 Sign-of-life monitoring 5/11
 SIGUARD 11/53
 SIMATIC BATCH 6/2
 SIMATIC BATCH API 6/12
 SIMATIC IT 12/2
 SIMATIC Logon 2/3, 4/5
 SIMATIC Manager 4/2, 4/5
 SIMATIC NET 9/2
 SIMATIC PCS 7 BOX 3/2
 SIMATIC PCS 7 Industrial Workstation... 2/6
 SIMATIC PCS 7 MTA 11/6
 SIMATIC PDM 4/13
 SIMATIC PDM PCS 7 4/15
 SIMATIC PDM S7 4/15
 SIMATIC PDM Service 4/15
 SIMATIC PDM Single Point 4/14
 SIMATIC Route Control 7/2
 SIMATIC Safety Matrix 4/23
 Simulation 4/26
 SIPLUS 11/9
 SM 321 11/14
 SM 322 11/16
 SM 323 11/18
 SM 331 11/19
 SM 332 11/21
 SM 421, SM 422, SM 431, SM 432 11/4
 Starter systems 3/2
 StoragePlus 5/21
 Switches 9/6
 System architecture 1/10
 System documentation 2/2

T

TELEPERM M Manual Collection 2/2
 Terminal bus 9/4
 Terminal modules 11/6, 11/41
 Totally Integrated Automation 1/10
 Tower Kit 2/15
 Trends 5/10

V

Version Cross Manager 4/10
 Version Trail 4/11

W

Web Server 5/25
 WinAC Slot416 3/9
 Wireless LAN 9/30

Y

Y-Link 9/42

3RK1 301-0.....	11/51	6ES7 195-1B.....	9/40	6ES7 431-0.....	11/4
3RK1 903-0.....	11/51, 11/52	6ES7 195-1G.....	9/48, 11/12, 14/16	6ES7 431-1.....	11/4
3RK1 903-1.....	11/55	6ES7 195-1J.....	11/12	6ES7 431-7.....	11/4
3RK1 903-2.....	11/51, 11/52	6ES7 195-1K.....	11/12	6ES7 432-1.....	11/4
3RK1 903-3.....	11/52	6ES7 195-7HA.....	9/48, 11/12	6ES7 460.....	11/5
6AV6 371-1CF06-0DX0.....	14/11	6ES7 195-7HB.....	11/12	6ES7 461.....	11/5
6AV6 371-1CF06-2AX0.....	5/18, 5/24	6ES7 195-7HC.....	11/12	6ES7 468.....	11/5
6AV6 371-1DR06-1AX0.....	14/10	6ES7 195-7HD.....	9/48, 11/12, 14/16	6ES7 492.....	11/4
6AV6 371-1ES06-0AX0.....	5/28, 14/10	6ES7 195-7HF.....	9/48, 14/16	6ES7 648-0.....	2/15, 3/7, 3/12, 14/3
6AV6 371-1ES06-0CX0.....	5/28, 14/10	6ES7 195-7HG.....	9/48, 11/26	6ES7 648-1AA.....	2/15, 14/3
6AV8 107.....	2/17	6ES7 195-7KF.....	11/26	6ES7 648-2AF.....	2/15, 14/3
6DL2 804.....	11/38	6ES7 197-1LA.....	9/42, 10/23	6ES7 648-2BF.....	10/6
6DL5 900.....	2/3	6ES7 305-1.....	9/42, 9/48, 11/10, 14/16	6ES7 650-0L.....	14/2, 14/3
6DS1 916.....	5/8	6ES7 307-1.....	9/42, 9/48, 11/10, 14/16	6ES7 650-ONF.....	2/14, 4/3, 5/6, 6/4, 7/5
6EP1.....	3/12	6ES7 321-1B.....	11/14	6ES7 650-ONG.....	2/14, 5/6, 6/4, 7/5
6ES5.....	2/3	6ES7 321-1C.....	11/14	6ES7 650-ONH.....	2/14, 5/6, 6/4, 7/5
6ES7 131-4.....	11/46	6ES7 321-1E.....	11/14	6ES7 650-1A.....	11/7, 11/8
6ES7 131-7.....	11/35	6ES7 321-1FF01.....	11/14	6ES7 650-1B.....	11/8
6ES7 132-4.....	11/46	6ES7 321-1FF10.....	11/15	6ES7 650-1C.....	9/29, 15/4
6ES7 132-7.....	11/35	6ES7 321-1FH00.....	11/14	6ES7 650-2M.....	14/4
6ES7 134-4.....	11/48	6ES7 321-7BH.....	11/15	6ES7 650-2P.....	3/11
6ES7 134-7.....	11/36	6ES7 321-7RD.....	11/22	6ES7 650-2Q.....	3/7
6ES7 135-4.....	11/48	6ES7 321-7TH.....	11/15	6ES7 650-3G.....	14/4
6ES7 135-7.....	11/36	6ES7 322-1.....	11/16	6ES7 650-3X.....	3/13, 3/14
6ES7 138-4.....	11/48	6ES7 322-5F.....	11/17	6ES7 651-5AX.....	15/7, 15/13
6ES7 138-7A.....	11/36	6ES7 322-5G.....	11/17	6ES7 651-5CX.....	4/18, 4/19, 15/6
6ES7 138-7B.....	11/36	6ES7 322-5H.....	11/17	6ES7 651-6A.....	4/25
6ES7 138-7E.....	11/32	6ES7 322-5R.....	11/22	6ES7 651-6B.....	4/25
6ES7 141-4.....	11/60	6ES7 322-5S.....	11/22	6ES7 652-0XC.....	5/22, 14/11, 15/14
6ES7 142-4.....	11/60	6ES7 322-8B.....	11/17	6ES7 652-0XD.....	5/14, 14/10, 15/14
6ES7 144-4.....	11/62	6ES7 323-1B.....	11/18, 11/25	6ES7 652-0XX.....	2/5, 2/16, 5/18, 9/29
6ES7 145-4.....	11/62	6ES7 326-1R.....	11/25	6ES7 652-1EA.....	14/10
6ES7 148-4.....	11/63, 11/64	6ES7 326-2B.....	11/26	6ES7 952-1KP.....	10/22
6ES7 151-1.....	11/43	6ES7 331-1.....	11/19	6ES7 652-3A.....	5/17
6ES7 152-1.....	11/33	6ES7 331-7.....	11/19, 11/20, 11/22, 11/24	6ES7 652-3B.....	5/18
6ES7 153-2AR03-0XA0.....	11/13	6ES7 332-5.....	11/21, 11/22, 11/24	6ES7 652-3X.....	14/11
6ES7 153-2BA02-0XB0.....	11/11	6ES7 332-7.....	11/21	6ES7 652-5A.....	15/9, 15/14
6ES7 153-2BA81-0XB0.....	14/16	6ES7 332-8.....	11/24	6ES7 652-5B.....	15/11, 15/15
6ES7 153-2BA82-0XB0.....	9/48	6ES7 336-1.....	11/26	6ES7 652-5C.....	15/9, 15/14
6ES7 153-2BB00-0XB0.....	11/11	6ES7 341-1.....	9/52	6ES7 652-5D.....	15/9
6ES7 154-2.....	11/59	6ES7 350.....	11/29	6ES7 652-5F.....	15/12
6ES7 157-0.....	9/48, 9/49, 14/16	6ES7 355.....	11/28	6ES7 652-6.....	5/15
6ES7 193-4CA.....	11/42	6ES7 370.....	11/12	6ES7 653-0S.....	14/8
6ES7 193-4CB.....	11/42	6ES7 390-1AB.....	9/38, 11/37	6ES7 653-1X.....	2/3
6ES7 193-4CC.....	11/41	6ES7 390-1AE.....	9/38, 9/48, 11/37, 14/16	6ES7 653-2B.....	3/7, 3/12, 10/6, 10/13, 10/21, 10/32
6ES7 193-4CD.....	11/41	6ES7 390-1AF.....	9/38, 9/48, 11/37, 14/16	6ES7 654-0JX.....	14/17
6ES7 193-4CE.....	11/41	6ES7 390-1AF85.....	11/33, 11/36	6ES7 654-0KX.....	14/18
6ES7 193-4CF.....	11/42	6ES7 390-1AJ30.....	9/38, 11/37	6ES7 654-0LX.....	14/18
6ES7 193-4CG.....	11/42	6ES7 390-1AJ85.....	11/33, 11/36	6ES7 654-0MX.....	14/19
6ES7 193-4CK.....	11/41	6ES7 390-1BC.....	9/38, 11/37	6ES7 654-0NX.....	14/19
6ES7 193-4CL.....	11/42	6ES7 392-1AJ.....	9/51, 11/12	6ES7 654-OPX.....	14/20
6ES7 193-7AA.....	11/33	6ES7 392-1AJ.....	11/12	6ES7 654-OQX.....	14/17
6ES7 193-7AB.....	11/33	6ES7 392-1AM.....	11/12	6ES7 654-ORX.....	14/20
6ES7 193-7CA.....	11/36	6ES7 392-1BJ.....	11/12	6ES7 654-OUC.....	10/6
6ES7 193-7DA.....	11/32	6ES7 392-1BM.....	11/12	6ES7 654-0XX.....	11/13
6ES7 193-7DB.....	11/32	6ES7 392-1CJ.....	11/12	6ES7 654-1J.....	14/17
6ES7 194-4A.....	11/59	6ES7 392-1CM.....	11/12	6ES7 654-1K.....	14/18
6ES7 194-4B.....	11/64	6ES7 393-4AA.....	11/12	6ES7 654-1L.....	14/18
6ES7 194-4C.....	11/60, 11/62	6ES7 400-1JA01.....	11/5	6ES7 654-1Q.....	14/17
6ES7 194-4D.....	11/63	6ES7 400-1TA01.....	11/5		
6ES7 194-4G.....	11/59	6ES7 421-1.....	11/4		
6ES7 194-4HA.....	11/60, 11/62	6ES7 421-7.....	11/4		
6ES7 194-4HB.....	11/59, 11/64	6ES7 422-1.....	11/4		
		6ES7 422-7.....	11/4		

Appendix

Order no. index

6ES7 654-2M...	14/19	6ES7 658-2BA07-0YA0	5/13	6ES7 658-3XD06-2YB5	4/19, 14/7
6ES7 654-2N...	14/19	6ES7 658-2BA16-0YA0	14/9	6ES7 658-3XD06-2YD5	4/17, 4/19, 14/7
6ES7 654-2P...	14/20	6ES7 658-2BB07-...	5/13	6ES7 658-3XH06-2YD5	4/17, 4/19, 14/7
6ES7 654-2R...	14/20	6ES7 658-2BB16-...	14/9	6ES7 658-3XX00-0YL8	4/18, 4/19, 15/3, 15/6
6ES7 654-3J...	14/17	6ES7 658-2BC07-...	5/13	6ES7 658-5AA07-0YA5	4/9
6ES7 654-3K...	14/18	6ES7 658-2BC16-0YA0	14/9	6ES7 658-5AA16-0YA5	14/5
6ES7 654-3L...	14/18	6ES7 658-2BC16-0YD0	14/9	6ES7 658-5AA16-0YE5	15/13
6ES7 654-3Q...	14/17	6ES7 658-2BC16-0YE0	15/14	6ES7 658-5AB07-0YA5	4/9
6ES7 654-4J...	14/17	6ES7 658-2BD07-...	5/13	6ES7 658-5AB07-0YD5	3/7, 3/12, 4/9
6ES7 654-4K...	14/18	6ES7 658-2BD16-...	14/9	6ES7 658-5AB16-0YA5	14/5
6ES7 654-4L...	14/18	6ES7 658-2BE07-...	5/13	6ES7 658-5AB16-0YD5	14/5
6ES7 654-4M...	14/19	6ES7 658-2BE16-0YA0	14/9	6ES7 658-5AC07-0YA5	4/9
6ES7 654-4N...	14/19	6ES7 658-2BE16-0YD0	14/9	6ES7 658-5AC07-0YD5	3/7, 3/12, 4/9
6ES7 654-4P...	14/20	6ES7 658-2BE16-0YE0	15/14	6ES7 658-5AC16-...	14/5
6ES7 654-4Q...	14/17	6ES7 658-2BF07-...	5/13	6ES7 658-5AD16-...	14/5
6ES7 654-4R...	14/20	6ES7 658-2BF16-...	14/9	6ES7 658-5AE16-...	14/5
6ES7 654-6J...	14/17	6ES7 658-2CX00-0YL8	15/3	6ES7 658-5AF07-...	4/9
6ES7 654-6K...	14/18	6ES7 658-2CX07-0YA5	5/13	6ES7 658-5AF16-...	14/5
6ES7 654-6L...	14/18	6ES7 658-2CX07-0YA5	5/26	6ES7 658-7BX41-...	2/5
6ES7 654-6Q...	14/17	6ES7 658-2CX16-0YA5	14/12	6ES7 658-7DX00-...	15/3
6ES7 654-7-...	10/13, 10/14, 10/22, 10/23, 10/33, 10/34	6ES7 658-2CX16-0YA5	14/9	6ES7 658-7DX07-...	7/9
6ES7 654-8-...	10/11, 10/12, 10/13, 10/20, 10/30, 10/31	6ES7 658-2CX16-0YE5	15/14	6ES7 658-7DX16-0YB5	14/6, 14/14
6ES7 656-7-...	10/22, 10/33	6ES7 658-2DA-...	14/5	6ES7 658-7DX16-0YF5	15/15
6ES7 656-8-...	10/20, 10/21, 10/31, 10/32	6ES7 658-2DB-...	14/5	6ES7 658-7EX07-0YB5	7/7
6ES7 657-0AX...	6/9, 14/13	6ES7 658-2DC16-0YA5	14/5	6ES7 658-7EX16-0YB5	14/14
6ES7 657-0BX...	6/10, 14/13	6ES7 658-2DC16-0YA6	14/5	6ES7 658-7EX16-0YF5	15/15
6ES7 657-0FX...	6/11, 14/13	6ES7 658-2DC16-0YD5	14/5	6ES7 658-7FA07-0YB0	7/7
6ES7 657-0GX...	6/12, 14/13	6ES7 658-2DC16-0YE5	15/13	6ES7 658-7FA16-0YB0	14/14
6ES7 657-0HX...	6/12, 14/13	6ES7 658-2DD-...	14/5	6ES7 658-7FB07-0YD0	7/7
6ES7 657-0LX...	6/8, 14/13	6ES7 658-2DE16-0YA5	14/5	6ES7 658-7FB16-0YD0	14/14
6ES7 657-0MX...	6/12, 14/13	6ES7 658-2DE16-0YD5	14/5	6ES7 658-7FC07-0YD0	7/7
6ES7 657-0SA...	6/7, 14/13, 15/3	6ES7 658-2DE16-0YE5	15/13	6ES7 658-7FC16-0YD0	14/14
6ES7 657-0XB...	6/7, 14/13	6ES7 658-2DF07-...	4/9	6ES7 658-7GA07-2YB0	8/5
6ES7 657-0XC...	6/7, 14/13	6ES7 658-2DF16-...	14/5	6ES7 658-7GA16-0YB0	14/15
6ES7 657-0XD...	6/7, 14/13	6ES7 658-2EA07-2YB0	5/20, 5/24	6ES7 658-7GB07-0YB0	8/5
6ES7 657-0XE...	6/7, 14/13	6ES7 658-2EA16-2YD0	14/10	6ES7 658-7GB07-2YB0	8/5
6ES7 657-0XX...	15/3, 15/15	6ES7 658-2EB07-2YB0	5/20, 5/24	6ES7 658-7GB16-0YD0	14/15
6ES7 657-5XX...	15/10, 15/15	6ES7 658-2EB07-2YD0	5/20, 5/24	6ES7 658-7GB16-0YD5	8/5
6ES7 658-0GX07-2YB0	5/28	6ES7 658-2EB16-2YD0	14/10	6ES7 658-7GC16-0YD0	14/15
6ES7 658-0HX07-2YB0	5/28	6ES7 658-2EC07-2YB0	5/20, 5/24	6ES7 658-7GD16-0YD0	14/15
6ES7 658-1AA16-0YA5	14/5	6ES7 658-2EC07-2YD0	5/20, 5/24	6ES7 658-7GH16-0YD0	14/15
6ES7 658-1AB05-0YC4	15/16	6ES7 658-2ED07-...	5/24	6ES7 658-7GX00-0YL8	15/3
6ES7 658-1AB16-...	14/5	6ES7 658-2EE07-...	5/24	6ES7 658-7GX07-0YB5	8/5
6ES7 658-1AC16-...	14/5	6ES7 658-2EE16-...	14/10	6ES7 658-7GX16-0YB5	14/15
6ES7 658-1AD16-0YA5	14/5	6ES7 658-2EF07-...	5/24	6ES7 833-1CC00-...	10/33, 14/20
6ES7 658-1AD16-0YD5	14/5	6ES7 658-2FA07-...	5/24	6ES7 833-1CC01-...	4/22, 14/6
6ES7 658-1AD16-0YE5	15/13	6ES7 658-2FX16-...	14/11	6ES7 833-1SM00-0YA5	4/24, 14/6
6ES7 658-1AE16-...	14/5	6ES7 658-2GA07-...	5/26	6ES7 833-1SM40-0YA5	4/24, 14/6
6ES7 658-1AF07-...	4/9	6ES7 658-2GA16-...	14/12	6ES7 833-1SM60-0YA5	14/10
6ES7 658-1AF16-...	14/5	6ES7 658-2GB07-...	5/26		
6ES7 658-1AF16-0YE5	15/13	6ES7 658-2GB16-...	14/12		
6ES7 658-1CX07-...	4/10	6ES7 658-2GC07-...	5/26		
6ES7 658-1CX16-...	14/6	6ES7 658-2GC16-...	14/12		
6ES7 658-1DX07-...	4/12	6ES7 658-2GD07-2YB0	5/26		
6ES7 658-1DX16-...	14/6	6ES7 658-2GD07-2YD0	5/26		
6ES7 658-1EX00-...	15/3	6ES7 658-2GD16-...	14/12		
6ES7 658-1FX07-...	4/11	6ES7 658-2GX00-...	15/3		
6ES7 658-1FX16-...	14/6	6ES7 658-2HX07-...	5/26		
6ES7 658-1XX00-...	15/3	6ES7 658-2HX16-...	14/12		
6ES7 658-2AA07-...	5/12	6ES7 658-2JX07-...	14/12		
6ES7 658-2AA16-...	14/9	6ES7 658-2XB05-...	15/16		
6ES7 658-2AB07-0YA0	5/12	6ES7 658-2XX00-...	15/3		
6ES7 658-2AB07-0YD0	3/7, 3/12, 5/12	6ES7 658-3AX06-...	14/7		
6ES7 658-2AB16-...	14/9	6ES7 658-3AX06-0YA5	4/18		
6ES7 658-2AC07-0YA0	5/12	6ES7 658-3AX06-0YA6	4/18, 14/7		
6ES7 658-2AC07-0YD0	3/7, 3/12, 5/12	6ES7 658-3AX06-2YB5	4/19, 14/7		
6ES7 658-2AC16-0YA0	14/9	6ES7 658-3CX06-2YB5	4/19, 14/7		
6ES7 658-2AC16-0YD0	14/9	6ES7 658-3EX06-2YB5	4/19, 14/7		
6ES7 658-2AC16-0YE0	15/14	6ES7 658-3GX06-0YC8	4/18, 4/19		
6ES7 658-2AD07-...	5/12	6ES7 658-3HX06-0YA5	4/18, 14/7		
6ES7 658-2AD16-...	14/9	6ES7 658-3JX06-0YA5	4/18, 14/8		
6ES7 658-2AE07-...	5/12	6ES7 658-3KX06-0YA5	4/18, 14/8		
6ES7 658-2AE16-0YA0	14/9	6ES7 658-3LX06-0YA5	3/7, 3/12, 4/17, 14/8		
6ES7 658-2AE16-0YD0	14/9	6ES7 658-3XA06-2YB5	4/19, 14/7		
6ES7 658-2AE16-0YE0	15/14	6ES7 658-3XB06-2YB5	4/19, 14/7		
		6ES7 658-3XB06-2YD5	4/17, 4/19, 14/7		
		6ES7 658-3XC06-2YB5	4/19, 14/7		
		6ES7 658-3XC06-2YD5	4/17, 4/19, 14/7		

6ES7 841-OCA01-0YX2	4/26, 15/3, 15/7	6GK5 101-.....	9/22	A5E00504378	5/18
6ES7 841-OCC04-0YA5	14/8	6GK5 2.	9/20	A5E00504378	6/4
6ES7 841-OCC05-0YA5	4/26	6GK5 3.	9/20	A5E00504378	9/29
6ES7 841-OCC05-0YE5	4/26, 15/7	6GK5 4.	9/20		
6ES7 870-.....	9/52	6GK5 6.	9/34		
6ES7 900-0.....	2/15, 14/3	6GK5 7.	9/32		
6ES7 902-1AB00-0AA0	9/52	6GK7 343-2.....	9/51		
6ES7 902-1AC00-0AA0	5/18, 5/24, 9/52	6GK7 443-1.....	9/29		
6ES7 902-1AD00-0AA0	9/52	6GK7 443-5.....	9/41		
6ES7 902-2.....	9/52	6XV1 820-5BH10	9/27, 9/39		
6ES7 902-3.....	9/52	6XV1 820-5BH30	9/27		
6ES7 922-.....	11/8	6XV1 820-5BH50	9/27, 9/39		
6ES7 952-1KP.	10/13, 10/33	6XV1 820-5BN10	9/27, 9/39		
6ES7 960-1AA.....	10/22, 10/33	6XV1 820-5BN20	9/27, 9/39		
6ES7 964-2AA04-0AB0	9/41	6XV1 820-5BN50	9/27, 9/39		
6ES7 972-0AA01-0XA0	9/38	6XV1 820-5BT10	9/27, 9/39		
6ES7 972-0AB01-0XA0	9/38	6XV1 820-5BT20	9/27		
6ES7 972-0AC80-0XA0	9/38, 11/33, 11/37	6XV1 820-5BT30	9/27		
6ES7 972-0BA50-0XA0	9/38	6XV1 821-0AH10	9/40		
6ES7 972-0BB50-0XA0	9/38	6XV1 821-2AN50	9/40		
6ES7 972-0DA00-0AA0	9/38	6XV1 830-0EH10	9/38, 11/37		
6ES7 972-0DA60-0XA0	9/38, 11/33, 11/37	6XV1 830-0EN20	9/38		
6ES7 998-.....	2/3	6XV1 830-0EN50	9/38		
6GF6 220-.....	2/17	6XV1 830-0ET10	9/38		
6GK1 105-.....	9/22	6XV1 830-0ET20	9/38		
6GK1 161-.....	5/7, 5/18, 9/29	6XV1 830-0ET50	9/38		
6GK1 415-.....	9/51	6XV1 830-0EU10	9/38		
6GK1 500-0.....	9/38	6XV1 830-5EH10	9/50		
6GK1 500-3.....	9/40	6XV1 830-5FH10	9/50		
6GK1 503-3.....	9/39	6XV1 840-2AH10	9/24, 9/32		
6GK1 704-0AA07-3AA0	15/5	6XV1 840-2AU10	9/24		
6GK1 704-1CW63-3AB0	15/5	6XV1 850-.....	9/25		
6GK1 716-0HB63-3AB0	15/5	6XV1 870-2E	9/24		
6GK1 716-0HB63-3AD0	15/5	6XV1 870-2J	9/32		
6GK1 716-0HB64-3AA0	5/18, 9/29, 15/4	6XV1 873-.....	9/27		
6GK1 716-0HB64-3AC0	5/18, 9/29, 15/4	6XV2 175-.....	5/8		
6GK1 716-0HB64-3AE0	15/4, 15/7, 15/9, 15/11				
6GK1 716-1CB63-.....	15/5				
6GK1 716-1CB64-.....	5/7, 5/18, 9/29, 15/4				
6GK1 900-0AB00	9/20				
6GK1 900-0AB00	9/34				
6GK1 901-0CA00-0AA0	9/25				
6GK1 901-0CA01-0AA0	9/25				
6GK1 901-0DA20-0AA0	9/27				
6GK1 901-0DA20-0AA0	9/39				
6GK1 901-0FB00-0AA0	9/40				
6GK1 901-1BB10-.....	9/24				
6GK1 901-1BB20-.....	9/24				
6GK1 901-1BE00-0AA1	9/24				
6GK1 901-1BE00-0AA2	9/24				
6GK1 901-1BE00-0AA3	9/32				
6GK1 901-1FC00-.....	9/24				
6GK1 901-1G.....	9/24				
6GK1 905-0A.....	9/50				
6GK1 905-6AA00	9/38, 9/50				
6GK1 905-6AB00	9/38, 9/50				
6GK1 905-6PA10	9/40				
6GK1 907-0.....	9/32				
6GK1 970-1.....	9/24				
6GK1 971-2.....	9/51				

Appendix

Notes

Appendix

Conditions of sale and delivery Export regulations

Terms and Conditions of Sale and Delivery

By using this catalog you can acquire hardware and software products described therein from Siemens AG subject to the following terms. Please note! The scope, the quality and the conditions for supplies and services, including software products, by any Siemens entity having a registered office outside of Germany, shall be subject exclusively to the General Terms and Conditions of the respective Siemens entity. The following terms apply exclusively for orders placed with Siemens AG.

For customers with a seat or registered office in Germany

The "General Terms of Payment" as well as the "General Conditions for the Supply of Products and Services of the Electrical and Electronics Industry" shall apply.

For software products, the "General License Conditions for Software Products for Automation and Drives for Customers with a Seat or registered Office in Germany" shall apply.

For customers with a seat or registered office outside of Germany

The "General Terms of Payment" as well as the "General Conditions for Supplies of Siemens. Automation and Drives for Customers with a Seat or registered Office outside of Germany" shall apply.

For software products, the "General License Conditions for Software Products for Automation and Drives for Customers with a Seat or registered Office outside of Germany" shall apply.

General

The dimensions are in mm. In Germany, according to the German law on units in measuring technology, data in inches only apply to devices for export.

Illustrations are not binding.

Insofar as there are no remarks on the corresponding pages, - especially with regard to data, dimensions and weights given - these are subject to change without prior notice.

The prices are in € (Euro) ex works, exclusive packaging.

The sales tax (value added tax) is not included in the prices. It shall be debited separately at the respective rate according to the applicable legal regulations.

Prices are subject to change without prior notice. We will debit the prices valid at the time of delivery.

Surcharges will be added to the prices of products that contain silver, copper, aluminum, lead and/or gold if the respective basic official prices for these metals are exceeded. These surcharges will be determined based on the official price and the metal factor of the respective product.

The surcharge will be calculated on the basis of the official price on the day prior to receipt of the order or prior to the release order.

The metal factor determines the official price as of which the metal surcharges are charged and the calculation method used. The metal factor, provided it is relevant, is included with the price information of the respective products.

An exact explanation of the metal factor and the text of the Comprehensive Terms and Conditions of Sale and Delivery are available free of charge from your local Siemens business office under the following Order Nos.:

- 6ZB5310-0KR30-0BA1
(for customers based in Germany)
- 6ZB5310-0KS53-0BA1
(for customers based outside Germany)

or download them from the Internet
<http://www.siemens.com/automation/mall>
(Germany: A&D Mall Online-Help System)

Export regulations

The products listed in this catalog / price list may be subject to European / German and/or US export regulations.

Therefore, any export requiring a license is subject to approval by the competent authorities.

According to current provisions, the following export regulations must be observed with respect to the products featured in this catalog / price list:

AL	Number of the <u>German Export List</u> Products marked other than "N" require an export license. In the case of software products, the export designations of the relevant data medium must also be generally adhered to. Goods labeled with an " <u>AL" not equal to "N"</u> are subject to a European or German export authorization when being exported out of the EU.
ECCN	<u>Export Control Classification Number</u> Products marked other than "N" are subject to a reexport license to specific countries. In the case of software products, the export designations of the relevant data medium must also be generally adhered to. Goods labeled with an " <u>ECCN" not equal to "N"</u> are subject to a US re-export authorization.

Even without a label or with an "AL: N" or "ECCN: N", authorization may be required due to the final destination and purpose for which the goods are to be used.

The deciding factors are the AL or ECCN export authorization indicated on order confirmations, delivery notes and invoices.

Errors excepted and subject to change without prior notice.

A&D/VuL_ohne MZ/En 05.09.06

Catalogs of the Automation and Drives Group (A&D)

Further information can be obtained from our branch offices listed in the appendix or at www.siemens.com/automation/partner

Automation and Drives	<i>Catalog</i>	Industrial Communication for Automation and Drives	<i>Catalog</i> IK PI
Interactive catalog on CD-ROM and on DVD			
• The Offline Mall of Automation and Drives	CA 01		
Automation Systems for Machine Tools		Low-Voltage	
SINUMERIK & SIMODRIVE	NC 60	Controls and Distribution – SIRIUS, SENTRON, SIVACON	LV 1
SINUMERIK & SINAMICS	NC 61	Controls and Distribution – Technical Information SIRIUS, SENTRON, SIVACON	LV 1 T
		SIDAC Reactors and Filters	LV 60
		SIVENT Fans	LV 65
		SIVACON 8PS Busbar Trunking Systems	LV 70
Drive Systems		Motion Control System SIMOTION	PM 10
<u>Variable-Speed Drives</u>			
SINAMICS G110/SINAMICS G120 Inverter Chassis Units	D 11.1	Process Instrumentation and Analytics	
SINAMICS G120D Distributed Frequency Inverters		Field Instruments for Process Automation	FI 01
SINAMICS G130 Drive Converter Chassis Units, SINAMICS G150 Drive Converter Cabinet Units	D 11	Measuring Instruments for Pressure, Differential Pressure, Flow, Level and Temperature, Positioners and Liquid Meters	
SINAMICS GM150/SINAMICS SM150 Medium-Voltage Converters	D 12	<i>PDF: Indicators for panel mounting</i>	MP 12
SINAMICS S120 Drive Converter Systems	D 21.1	SIREC Recorders and Accessories	MP 20
SINAMICS S150 Drive Converter Cabinet Units	D 21.3	SIPART, Controllers and Software	MP 31
Asynchronous Motors Standardline	D 86.1	SIWAREX Weighing Systems	WT 01
Synchronous Motors with Permanent-Magnet Technology, HT-direct	D 86.2	Continuous Weighing and Process Protection	WT 02
DC Motors	DA 12	Process Analytical Instruments	PA 01
SIMOREG DC MASTER 6RA70 Digital Chassis Converters	DA 21.1	<i>PDF: Process Analytics, Components for the System Integration</i>	PA 11
SIMOREG K 6RA22 Analog Chassis Converters	DA 21.2		
<i>PDF: SIMOREG DC MASTER 6RM70 Digital Converter Cabinet Units</i>	DA 22		
SIMOVERT PM Modular Converter Systems	DA 45		
SIEMOSYN Motors	DA 48		
MICROMASTER 410/420/430/440 Inverters	DA 51.2		
MICROMASTER 411/COMBIMASTER 411	DA 51.3		
SIMOVERT MASTERDRIVES Vector Control	DA 65.10		
SIMOVERT MASTERDRIVES Motion Control	DA 65.11		
Synchronous and asynchronous servomotors for SIMOVERT MASTERDRIVES	DA 65.3		
SIMODRIVE 611 universal and POSMO	DA 65.4		
<u>Low-Voltage Three-Phase-Motors</u>			
IEC Squirrel-Cage Motors	D 81.1		
IEC Squirrel-Cage Motors · New Generation 1LE1	D 81.1 N		
<i>PDF: Geared Motors</i>	M 15		
<u>Automation Systems for Machine Tools SIMODRIVE</u>	NC 60		
• Main Spindle/Feed Motors			
• Converter Systems SIMODRIVE 611/POSMO			
<u>Automation Systems for Machine Tools SINAMICS</u>	NC 61		
• Main Spindle/Feed Motors			
• Drive System SINAMICS S120			
<u>Drive and Control Components for Hoisting Equipment</u>	HE 1		
Electrical Installation Technology		SIMATIC Industrial Automation Systems	
<i>PDF: ALPHA Small Distribution Boards and Distribution Boards, Terminal Blocks</i>	ETA 1	SIMATIC PCS Process Control System	ST 45
<i>PDF: ALPHA 8HP Molded-Plastic Distribution System</i>	ETA 3	Products for Totally Integrated Automation and Micro Automation	ST 70
<i>PDF: BETA Low-Voltage Circuit Protection</i>	ET B1	SIMATIC PCS 7 Process Control System	ST PCS 7
<i>PDF: DELTA Switches and Socket Outlets</i>	ET D1	Add-ons for the SIMATIC PCS 7 Process Control System	ST PCS 7.1
GAMMA Building Controls	ET G1	Migration solutions with the SIMATIC PCS 7 Process Control System	ST PCS 7.2
		pc-based Automation	ST PC
		SIMATIC Control Systems	ST DA
Human Machine Interface Systems SIMATIC HMI	ST 80	SIMATIC Sensors	
		Sensors for Factory Automation	FS 10
		Systems Engineering	
		Power supplies SITOP power	KT 10.1
		System cabling SIMATIC TOP connect	KT 10.2
		System Solutions	
		Applications and Products for Industry are part of the interactive catalog CA 01	
		TELEPERM M Process Control System	
		<i>PDF: AS 488/TM automation systems</i>	PLT 112

www.siemens.com/simatic-pcs7

Siemens AG

Automation and Drives
Industrial Automation Systems
Postfach 48 48
90327 NÜRNBERG
GERMANY

www.siemens.com/automation

The information provided in this catalog contains descriptions or characteristics of performance which in case of actual use do not always apply as described or which may change as a result of further development of the products. An obligation to provide the respective characteristics shall only exist if expressly agreed in the terms of contract. Availability and technical specifications are subject to change without notice.

All product designations may be trademarks or product names of Siemens AG or supplier companies whose use by third parties for their own purposes could violate the rights of the owners.

Order No. E86060-K4678-A111-B3-7600