



GE Fanuc Automation

Computer Numerical Control Products

*Beta Series Servo Motor
I/O Link Option*

Maintenance Manual

GFZ-65245EN/01

September 1997

Warnings, Cautions, and Notes as Used in this Publication

Warning

Warning notices are used in this publication to emphasize that hazardous voltages, currents, temperatures, or other conditions that could cause personal injury exist in this equipment or may be associated with its use.

In situations where inattention could cause either personal injury or damage to equipment, a Warning notice is used.

Caution

Caution notices are used where equipment might be damaged if care is not taken.

Note

Notes merely call attention to information that is especially significant to understanding and operating the equipment.

This document is based on information available at the time of its publication. While efforts have been made to be accurate, the information contained herein does not purport to cover all details or variations in hardware or software, nor to provide for every possible contingency in connection with installation, operation, or maintenance. Features may be described herein which are not present in all hardware and software systems. GE Fanuc Automation assumes no obligation of notice to holders of this document with respect to changes subsequently made.

GE Fanuc Automation makes no representation or warranty, expressed, implied, or statutory with respect to, and assumes no responsibility for the accuracy, completeness, sufficiency, or usefulness of the information contained herein. No warranties of merchantability or fitness for purpose shall apply.

**FANUC SERVO MOTOR series
FANUC SERVO MOTOR AMPLIFIER series
SAFETY PRECAUTIONS**

This "Safety Precautions" section describes the precautions which must be observed to ensure safety when using FANUC servo motors (including spindle motors) and servo amplifiers (including spindle amplifiers). Users of any servo motor or amplifier model are requested to read the "Safety Precautions" carefully before using the servo motor or amplifier.

The users are also requested to read an applicable specification manual carefully and understand each function of the motor or amplifier for correct use.

The users are basically forbidden to do any behavior or action not mentioned in the "Safety Precautions." They are invited to ask FANUC previously about what behavior or action is prohibited.

Contents

DEFINITION OF WARNING, CAUTION, AND NOTE s-3

I. FANUC SERVO MOTOR series s-5

1. WARNING s-7

2. CAUTION s-9

3. NOTE s-11

II. FANUC SERVO MOTOR AMPLIFIER series s-13

1. WARNINGS AND CAUTIONS RELATING TO MOUNTING s-15

2. WARNINGS AND CAUTIONS RELATING TO A PILOT RUN s-20

3. WARNINGS AND CAUTIONS RELATING TO MAINTENANCE s-22

DEFINITION OF WARNING, CAUTION, AND NOTE



This manual includes safety precautions for protecting the user and preventing damage to the machine. Precautions are classified into Warning and Caution according to their bearing on safety. Also, supplementary information is described as a Note. Read the Warning, Caution, and Note thoroughly before attempting to use the machine.

WARNING

Applied when there is a danger of the user being injured or when there is a damage of both the user being injured and the equipment being damaged if the approved procedure is not observed.

CAUTION

Applied when there is a danger of the equipment being damaged, if the approved procedure is not observed.

NOTE

The Note is used to indicate supplementary information other than Warning and Caution.

- **Read this manual carefully, and store it in a safe place.**

I. FANUC SERVO MOTOR series

1

WARNING

WARNING

- **Be safely dressed when handling a motor.**

Wear safety shoes or gloves when handling a motor as you may get hurt on any edge or protrusion on it or electric shocks.

- **Use a crane or lift to move a motor from one place to another.**

Motors are heavy. When moving them, use a crane or lift as required. (For the weight of motors, refer to their respective specification manuals.)

When moving a motor using a crane or lift, use a hanging bolt if the motor has a corresponding tapped hole, or textile rope if it has no tapped hole. If a motor is attached with a machine or any other heavy stuff, do not use a hanging bolt to move the motor as the hanging bolt and/or motor may get broken. When moving a motor, be careful not to apply excessive force to its windings as the windings may break and/or their insulation may deteriorate.

- **Do not touch a motor with a wet hand.**

A failure to observe this caution is vary dangerous because you may get electric shocks.

- **Before starting to connect a motor to electric wires, make sure they are isolated from an electric power source.**

A failure to observe this caution is vary dangerous because you may get electric shocks.

- **Do not bring any dangerous stuff near a motor.**

Motors are connected to a power line, and may get hot. If a flammable is placed near a motor, it may be ignited, catch fire, or explode.

- **Be sure to ground a motor frame.**

To avoid electric shocks, be sure to connect the grounding terminal in the terminal box to the grounding terminal of the machine.

- **Do not ground a motor power wire terminal or short-circuit it to another power wire terminal.**

A failure to observe this caution may cause electric shocks or a burned wiring.

* Some motors require a special connection such as a winding changeover. Refer to their respective motor specification manuals for details.

WARNING**● Connect power wires securely so that they will not get loose.**

A failure to observe this caution may cause a wire to be disconnected, resulting in a ground fault, short circuit, or electric shock.

● Do not supply the power to the motor while any terminal is exposed.

A failure to observe this caution is very dangerous because you may get electric shocks if your body or any conductive stuff touches an exposed terminal.

● Do not get close to a rotary section of a motor when it is rotating.

A rotating part may catch your cloths or fingers. Before starting a motor, ensure that there is no stuff that can fly away (such as a key) on the motor.

● Before touching a motor, shut off the power to it.

Even if a motor is not rotating, there may be a voltage across the terminals of the motor. Especially before touching a power supply connection, take sufficient precautions. Otherwise you may get electric shocks.

● Do not touch any terminal of a motor for a while (at least 5 minutes) after the power to the motor is shut off.

High voltage remains across power line terminals of a motor for a while after the power to the motor is shut off. So, do not touch any terminal or connect it to any other equipment. Otherwise, you may get electric shocks or the motor and/or equipment may get damaged.

● To drive a motor, use a specified amplifier and parameters.

An incorrect combination of a motor, amplifier, and parameters may cause the motor to behave unexpectedly. This is dangerous, and the motor may get damaged.

● Do not touch a motor when it is running or immediately after it stops.

A motor may get hot when it is running. Do not touch the motor before it gets cool enough. Otherwise, you may get burned.

● Be careful not get your hair or cloths caught in a fan.

Be careful especially for a fan used to generate an inward air flow.
Be careful also for a fan even when the motor is stopped, because it continues to rotate while the amplifier is turned on.

● Ensure that motors and related components are mounted securely.

If a motor or its component slips out of place or comes off when the motor is running, it is very dangerous.

2 CAUTION

CAUTION

- **FANUC motors are designed for use with machines. Do not use them for any other purpose.**

If a FANUC motor is used for an unintended purpose, it may cause an unexpected symptom or trouble. If you want to use a motor for an unintended purpose, previously consult with FANUC.

- **Ensure that a base or frame on which a motor is mounted is strong enough.**

Motors are heavy. If a base or frame on which a motor is mounted is not strong enough, it is impossible to achieve the required precision.

- **Be sure to connect motor cables correctly.**

An incorrect connection of a cable cause abnormal heat generation, equipment malfunction, or failure. Always use a cable with an appropriate current carrying capacity (or thickness). For how to connect cables to motors, refer to their respective specification manuals.

- **Ensure that motors are cooled if they are those that require forcible cooling.**

If a motor that requires forcible cooling is not cooled normally, it may cause a failure or trouble. For a fan-cooled motor, ensure that it is not clogged or blocked with dust and dirt. For a liquid-cooled motor, ensure that the amount of the liquid is appropriate and that the liquid piping is not clogged. For both types, perform regular cleaning and inspection.

- **When attaching a component having inertia, such as a pulley, to a motor, ensure that any imbalance between the motor and component is minimized.**

If there is a large imbalance, the motor may vibrates abnormally, resulting in the motor being broken.

- **Be sure to attach a key to a motor with a keyed shaft.**

If a motor with a keyed shaft runs with no key attached, it may impair torque transmission or cause imbalance, resulting in the motor being broken.

3

NOTE

NOTE

- **Do not step or sit on a motor.**

If you step or sit on a motor, it may get deformed or broken. Do not put a motor on another unless they are in packages.

- **When storing a motor, put it in a dry (non-condensing) place at room temperature (0 to 40 °C).**

If a motor is stored in a humid or hot place, its components may get damaged or deteriorated. In addition, keep a motor in such a position that its shaft is held horizontal and its terminal box is at the top.

- **Do not remove a nameplate from a motor.**

If a nameplate comes off, be careful not to lose it. If the nameplate is lost, the motor becomes unidentifiable, resulting in maintenance becoming impossible. For a nameplate for a built-in spindle motor, keep the nameplate with the spindle.

- **Do not apply shocks to a motor or cause scratches to it.**

If a motor is subjected to shocks or is scratched, its components may be adversely affected, resulting in normal operation being impaired. Be very careful when handling plastic portions, sensors, and windings, because they are very liable to break. Especially, avoid lifting a motor by pulling its plastic portion, winding, or power cable.

- **Do not conduct dielectric strength or insulation test for a detector.**

Such a test can damage elements in the detector.

- **When testing the winding or insulation resistance of a motor, satisfy the conditions stipulated in IEC34.**

Testing a motor under a condition severer than those specified in IEC34 may damage the motor.

- **Do not disassemble a motor.**

Disassembling a motor may cause a failure or trouble in it.

If disassembly is in need because of maintenance or repair, please contact a service representative of FANUC.

- **Do not modify a motor.**

Do not modify a motor unless directed by FANUC. Modifying a motor may cause a failure or trouble in it.

NOTE

- **Use a motor under an appropriate environmental condition.**

Using a motor in an adverse environment may cause a failure or trouble in it. Refer to their respective specification manuals for details of the operating and environmental conditions for motors.

- **Do not apply a commercial power source voltage directly to a motor.**

Applying a commercial power source voltage directly to a motor may result in its windings being burned. Be sure to use a specified amplifier for supplying voltage to the motor.

- **For a motor with a terminal box, make a conduit hole for the terminal box in a specified position.**

When making a conduit hole, be careful not to break or damage unspecified portions. Refer to an applicable specification manual.

- **Before using a motor, measure its winding and insulation resistances, and make sure they are normal.**

Especially for a motor that has been stored for a prolonged period of time, conduct these checks. A motor may deteriorate depending on the condition under which it is stored or the time during which it is stored. For the winding resistances of motors, refer to their respective specification manuals, or ask FANUC. For insulation resistances, see the following table.

- **To use a motor as long as possible, perform periodic maintenance and inspection for it, and check its winding and insulation resistances.**

Note that extremely severe inspections (such as dielectric strength tests) of a motor may damage its windings. For the winding resistances of motors, refer to their respective specification manuals, or ask FANUC. For insulation resistances, see the following table.

MOTOR INSULATION RESISTANCE MEASUREMENT

Measure an insulation resistance between each winding and motor frame using an insulation resistance meter (500 VDC). Judge the measurements according to the following table.

Insulation resistance	Judgment
100 M Ω or higher	Acceptable
10 to 100 M Ω	The winding has begun deteriorating. There is no problem with the performance at present. Be sure to perform periodic inspection.
1 to 10 M Ω	The winding has considerably deteriorated. Special care is in need. Be sure to perform periodic inspection.
Lower than 1 M Ω	Unacceptable. Replace the motor.

II. FANUC SERVO MOTOR AMPLIFIER series

1

WARNINGS AND CAUTIONS RELATING TO MOUNTING

WARNING

- **Check the specification code of the amplifier.**

Check that the delivered amplifier is as originally ordered.

- **Mount a ground fault interrupter.**

To guard against fire and electric shock, fit the factory power supply or machine with a ground fault interrupter (designed for use with an inverter).

- **Securely ground the amplifier.**

Securely connect the ground terminal and metal frame of the amplifier and motor to a common ground plate of the power magnetics cabinet.

- **Be aware of the weight of the amplifier and other components.**

Control motor amplifiers and AC reactors are heavy. When transporting them or mounting them in the cabinet, therefore, be careful not to injure yourself or damage the equipment. Be particularly careful not to jam your fingers between the cabinet and amplifier.

- **Never ground or short-circuit either the power supply lines or power lines.**

Protect the lines from any stress such as bending. Handle the ends appropriately.

- **Ensure that the power supply lines, power lines, and signal lines are securely connected.**

A loose screw, loose connection, or the like will cause a motor malfunction or overheating, or a ground fault.

- **Insulate all exposed parts that are charged.**

- **Never touch the regenerative discharge resistor or radiator directly.**

The surface of the radiator and regenerative discharge unit become extremely hot. Never touch them directly. An appropriate structure should also be considered.

- **Close the amplifier cover after completing the wiring.**

Leaving the cover open presents a danger of electric shock.

WARNING

- **Do not disassemble the amplifier.**
- **Ensure that the cables used for the power supply lines and power lines are of the appropriate diameter and temperature ratings.**
- **Do not apply an excessively large force to plastic parts.**

If a plastic section breaks, it may cause internal damage, thus interfering with normal operation. The edge of a broken section is likely to be sharp and, therefore, presents a risk of injury.

CAUTION**● Do not step or sit on the amplifier.**

Also, do not stack unpacked amplifiers on top of each other.

● Use the amplifier in an appropriate environment.

See the allowable ambient temperatures and other requirements, given in the corresponding descriptions.

● Protect the amplifier from corrosive or conductive mist or drops of water.

Use a filter if necessary.

● Protect the amplifier from impact.

Do not place anything on the amplifier.

● Do not block the air inlet to the radiator.

A deposit of coolant, oil mist, or chips on the air inlet will result in a reduction in the cooling efficiency. In some cases, the required efficiency cannot be achieved. The deposit may also lead to a reduction in the useful life of the semiconductors. Especially, when outside air is drawn in, mount filters on both the air inlet and outlet. These filters must be replaced regularly. So, an easy-to-replace type of filter should be used.

● Before connecting the power supply wiring, check the supply voltage.

Check that the supply voltage is within the range specified in this manual, then connect the power supply lines.

● Ensure that the combination of motor and amplifier is appropriate.**● Ensure that valid parameters are specified.**

Specifying an invalid parameter for the combination of motor and amplifier may not only prevent normal operation of the motor but also result in damage to the amplifier.

● Ensure that the amplifier and peripheral equipment are securely connected.

Check that the magnetic contactor, circuit breaker, and other devices mounted outside the amplifier are securely connected to each other and that those devices are securely connected to the amplifier.

● Check that the amplifier is securely mounted in the power magnetics cabinet.

If any clearance is left between the power magnetics cabinet and the surface on which the amplifier is mounted, dust entering the gap may build up and prevent the normal operation of the amplifier.

CAUTION**● Apply appropriate countermeasures against noise.**

Adequate countermeasures against noise are required to maintain normal operation of the amplifier. For example, signal lines must be routed away from power supply lines and power lines.

NOTE

- **Keep the nameplate clearly visible.**
- **Keep the legend on the nameplate clearly visible.**
- **After unpacking the amplifier, carefully check for any damage.**
- **Mount the amplifier in a location where it can be easily accessed to allow periodic inspection and daily maintenance.**
- **Leave sufficient space around the machine to enable maintenance to be performed easily.**

Do not place any heavy objects such that they would interfere with the opening of the doors.

- **Keep the parameter table and spare parts at hand.**

Also, keep the specifications at hand. These items must be stored in a location where they can be retrieved immediately.

- **Provide adequate shielding.**

A cable to be shielded must be securely connected to the ground plate, using a cable clamp or the like.

2 WARNINGS AND CAUTIONS RELATING TO A PILOT RUN

WARNING

- **Before turning on the power, check that the cables connected to the power magnetics cabinet and amplifier, as well as the power lines and power supply lines, are securely connected. Also, check that no lines are slack.**
- **Before turning on the power, ensure that the power magnetics cabinet is securely grounded.**
- **Before turning on the power, check that the door of the power magnetics cabinet and all other doors are closed.**

Ensure that the door of the power magnetics cabinet containing the amplifier, and all other doors, are securely closed. During operation, all doors must be closed and locked.

- **Apply extreme caution if the door of the power magnetics cabinet or another door must be opened.**

Only a person trained in the maintenance of the corresponding machine or equipment should open the door, and only after shutting off the power supply to the power magnetics cabinet (by opening both the input circuit breaker of the power magnetics cabinet and the factory switch used to supply power to the cabinet). If the machine must be operated with the door open to enable adjustment or for some other purpose, the operator must keep his or her hands and tools well away from any dangerous voltages. Such work must be done only by a person trained in the maintenance of the machine or equipment.

- **When operating the machine for the first time, check that the machine operates as instructed.**

To check whether the machine operates as instructed, first specify a small value for the motor, then increase the value gradually. If the motor operates abnormally, perform an emergency stop immediately.

- **After turning on the power, check the operation of the emergency stop circuit.**

Press the emergency stop button to check that the motor stops immediately, and that the power being supplied to the amplifier is shut off by the magnetic contactor.

- **Before opening a door or protective cover of a machine to enable adjustment of the machine, first place the machine in the emergency stop state and check that the motor has stopped.**

CAUTION

- **Note whether an alarm status relative to the amplifier is displayed at power-up or during operation.**

If an alarm is displayed, take appropriate action as explained in the maintenance manual. If the work to be done requires that the door of the power magnetics cabinet be left open, the work must be carried out by a person trained in the maintenance of the machine or equipment. Note that if some alarms are forcibly reset to enable operation to continue, the amplifier may be damaged. Take appropriate action according to the contents of the alarm.

- **Before operating the motor for the first time, mount and adjust the position and speed detectors.**

Following the instructions given in the maintenance manual, adjust the position and speed detectors for the spindle so that an appropriate waveform is obtained. If the detectors are not properly adjusted, the motor may not rotate normally or the spindle may fail to stop as desired.

- **If the motor makes any abnormal noise or vibration while operating, stop it immediately.**

Note that if operation is continued in spite of there being some abnormal noise or vibration, the amplifier may be damaged. Take appropriate corrective action, then resume operation.

- **Observe the ambient temperature and output rating requirements.**

The continuous output rating or continuous operation period of some amplifiers may fall as the ambient temperature increases. If the amplifier is used continuously with an excessive load applied, the amplifier may be damaged.

3

WARNINGS AND CAUTIONS RELATING TO MAINTENANCE

WARNING

- **Read the maintenance manual carefully and ensure that you are totally familiar with its contents.**

The maintenance manual describes daily maintenance and the procedures to be followed in the event of an alarm being issued. The operator must be familiar with these descriptions.

- **Notes on replacing a fuse or PC board**

- 1) Before starting the replacement work, ensure that the circuit breaker protecting the power magnetics cabinet is open.
- 2) Check that the red LED that indicates that charging is in progress is not lit. The position of the charging LED on each model of amplifier is given in this manual. While the LED is lit, hazardous voltages are present inside the unit, and thus there is a danger of electric shock.
- 3) Some PC board components become extremely hot. Be careful not to touch these components.
- 4) Ensure that a fuse having an appropriate rating is used.
- 5) Check the specification code of a PC board to be replaced. If a modification drawing number is indicated, contact FANUC before replacing the PC board. Also, before and after replacing a PC board, check its pin settings.
- 6) After replacing the fuse, ensure that the screws are firmly tightened. For a socket-type fuse, ensure that the fuse is inserted correctly.
- 7) After replacing the PC board, ensure that it is securely connected.
- 8) Ensure that all power lines, power supply lines, and connectors are securely connected.

- **Take care not to lose any screws.**

When removing the case or PC board, take care not to lose any screws. If a screw is lost inside the unit and the power is turned on, the machine may be damaged.

- **Notes on replacing the battery of the absolute pulse coder**

Replace the battery only while the power is on. If the battery is replaced while the power is turned off, the stored absolute positioning data will be lost. Some series servo amplifier modules have batteries in their servo amplifiers. To replace the battery of any of those models, observe the following procedure: Open the door of the power magnetics cabinet; Leave the control power of the power supply module on; Place the machine in the emergency stop state so that the power being input to the amplifier is shut off; Then, replace the battery. Replacement work should be done only by a person who is trained in the related maintenance and safety requirements. The power magnetics cabinet in which the servo amplifier is mounted has a high-voltage section. This section presents a severe risk of electric shock.

WARNING**● Check the number of any alarm.**

If the machine stops upon an alarm being issued, check the alarm number. Some alarms indicate that a component must be replaced. If the power is reconnected without first replacing the failed component, another component may be damaged, making it difficult to locate the original cause of the alarm.

● Before resetting an alarm, ensure that the original cause of the alarm has been removed.**● Contact FANUC whenever a question relating to maintenance arises.****● Notes on removing the amplifier**

Before removing the amplifier, first ensure that the power is shut off. Be careful not to jam your fingers between the power magnetics cabinet and amplifier.

CAUTION**● Ensure that all required components are mounted.**

When replacing a component or PC board, check that all components, including the snubber capacitor, are correctly mounted. If the snubber capacitor is not mounted, for example, the IPM will be damaged.

● Tighten all screws firmly.**● Check the specification code of the fuse, PC board, and other components.**

When replacing a fuse or PC board, first check the specification code of the fuse or PC board, then mount it in the correct position. The machine will not operate normally if a fuse or PC board having other than the correct specification code is mounted, or if a fuse or PC board is mounted in the wrong position.

● Mount the correct cover.

The cover on the front of the amplifier carries a label indicating a specification code. When mounting a previously removed front cover, take care to mount it on the unit from which it was removed.

● Notes on cleaning the heat sink and fan

- 1) A dirty heat sink or fan results in reduced semiconductor cooling efficiency, which degrades reliability. Periodic cleaning is necessary.
- 2) Using compressed air for cleaning scatters the dust. A deposit of conductive dust on the amplifier or peripheral equipment will result in a failure.
- 3) To clean the heat sink, do so only after turning the power off and ensuring that the heat sink has cooled to room temperature. The heat sink becomes extremely hot, such that touching it during operation or immediately after power-off is likely to cause a burn. Be extremely careful when touching the heat sink.

NOTE

- **Ensure that the battery connector is correctly inserted.**

If the power is shut off while the battery connector is not connected correctly, the absolute position data for the machine will be lost.

- **Store the manuals in a safe place.**

The manuals should be stored in a location where they can be accessed immediately if so required during maintenance work.

- **Notes on contacting FANUC**

Inform FANUC of the details of an alarm and the specification code of the amplifier so that any components required for maintenance can be quickly secured, and any other necessary action can be taken without delay.

PREFACE

The FANUC servo motor amplifier β series is available in two types: a PWM interface version and an I/O link interface version. This manual covers those points related to the maintenance of the FANUC servo motor amplifier β series (I/O link option) (servo amplifier unit (SVU)).

For an explanation of the maintenance of the PWM interface type, refer to the "FANUC SERVO MOTOR β series MAINTENANCE MANUAL (B-65235EN)."

Only one type of servo amplifier unit is used:

Abbreviation	Ordering code	Remarks
SVU	A06B-6093-H***	Conforming to VDE0160, UL, and CSA

Part I describes the start-up procedure. Part II describes specification from the host controller. Part III describes the troubleshooting procedure.

This manual may use the following abbreviation:

Abbreviation	Model name
A06B-6093-H***	SVU

In addition, the following manuals are available for the FANUC servo motor amplifier β series (servo amplifier unit):

- (1) FANUC SERVO MOTOR β series DESCRIPTIONS (B-65232EN)
- (2) FANUC AC SERVO MOTOR α series DESCRIPTIONS (B-65142EN)

WARNING

Before starting servo amplifier maintenance and inspection, turn off the power, and check that the LED (red) on the front of the servo amplifier, which indicates charging in progress, is off. (See Appendix A.)

SAFETY PRECAUTIONS	s-1
PREFACE	p-1
I. START-UP PROCEDURE	
1. OVERVIEW	3
2. CONFIGURATION	4
2.1 BASIC CONFIGURATION	5
2.2 MAJOR COMPONENTS	6
3. START-UP PROCEDURE	7
3.1 START-UP PROCEDURE (SUMMARY)	8
3.2 POWER SUPPLY CONNECTION	9
3.2.1 Checking the Power Supply Voltage and Capacity	9
3.2.2 Leakage Current and Ground Fault Interrupter	10
3.3 CONNECTION OF THE SEPARATE REGENERATIVE DISCHARGE UNIT	11
3.4 PARAMETER INITIALIZATION	12
4. OPERATION CHECK METHOD	15
4.1 CHECK PROCEDURE	16
II. HANDLING	
1. OVERVIEW	21
1.1 SERVO UNIT INTERFACE	22
1.2 I/O LINK INTERFACE AREA	23
1.3 INTERFACE	24
1.3.1 Peripheral Equipment Control Interface	24
1.3.2 Direct Command Interface	24
1.3.3 Interface Switching	24
1.4 CAUTIONS ON USING THE POWER MOTION MANAGER	25
2. SIGNAL DESCRIPTIONS	26
2.1 DO/DO SIGNALS	27
2.1.1 Peripheral Equipment Control Interface	27
2.1.2 Direct Command Interface	29
2.2 SIGNALS (LISTED IN GROUPS)	31
2.3 SIGNAL DETAILS	33
2.3.1 Preparation Completion	33
2.3.2 Reset and Emergency Stop	34
2.3.3 Alarm	35
2.3.4 Mode Selection	36
2.3.5 Jog Feed	36
2.3.6 Status Signals	37
2.3.7 Feedrate	40
2.3.8 Interlock	41
2.3.9 Reference Position Return	42

2.3.10	Automatic Operation	42
2.3.11	Clamp and Unclamp (for the Peripheral Equipment Control Interface Only)	43
2.3.12	Servo-off	44
2.3.13	Peripheral Equipment Control Function Code and Related Information	45
2.3.14	Direct Command Function Code and Related Information	47
2.3.15	Direct Input Signals	53
3.	PERIPHERAL EQUIPMENT CONTROL	54
3.1	COMMAND FORMAT FOR PERIPHERAL EQUIPMENT CONTROL	55
3.2	PERIPHERAL EQUIPMENT CONTROL PROCEDURE	56
3.2.1	Specifying Operation Using a Function Code	56
3.2.2	Receiving Response Data	56
3.3	FUNCTION CODES	57
3.3.1	Function Codes	57
3.4	DETAILS OF FUNCTION CODES	59
3.4.1	ATC/Turret Control	59
3.4.2	Point Positioning Control	61
3.4.3	Reference Position Return	63
3.4.4	Reference Position Setting (when the Reference Position External Setting Function is Used)	65
3.4.5	Positioning Control (Absolute/Incremental Specification)	67
3.4.6	Coordinate System Setting	69
3.4.7	Teaching-based Data Setting Control	70
3.4.8	Control of the Point Data External Setting Function	71
4.	DIRECT COMMANDS	72
4.1	DIRECT COMMAND FORMAT	73
4.2	DIRECT COMMAND CONTROL PROCEDURE	75
4.2.1	Direct Command Control Procedure	75
4.2.2	Instruction Command Control (EBUF, EBSY, and ECNT)	75
4.2.3	Response Command Control (EOREND, EOSTB, EOPC, USR1, and ECONTE)	76
4.2.4	Command Completion Notification (ECF)	76
4.2.5	Alarm (AL)	77
4.2.6	Direct Command Execution Result	77
4.3	DIRECT COMMANDS	78
4.4	DETAILS OF DIRECT COMMAND FUNCTIONS	79
4.4.1	Signal Operation Commands	79
4.4.2	Parameters	80
4.4.3	Status Read	82
4.4.4	Axis Movement Commands	91
4.5	THIRTY-TWO-BLOCK BUFFERING OPERATION	97
4.5.1	Outline	97
4.5.2	Memory Registration Procedure	97
4.5.3	Operation Procedure	97
5.	EXTERNAL PULSE INPUT FUNCTION	98
5.1	OUTLINE	99
5.2	DETAILED DESCRIPTION	100

III. TROUBLESHOOTING AND COUNTERMEASURES

1.	OVERVIEW	103
-----------	-----------------------	------------

2. ALARM DISPLAY AND CORRESPONDING COUNTERMEASURES	104
3. REPLACING FUSE	109
IV. MAINTENANCE OF SERVO UNIT	
1. REPLACING BATTERY OF THE ABSOLUTE PULSE CODER	113
V. MAINTENANCE OF SERVO MOTOR	
1. MAINTENANCE OF SERVO MOTOR	119
1.1 ACCEPTANCE INSPECTION AND SERVO MOTOR STORAGE	120
1.2 ROUTINE CHECK OF SERVO MOTOR	121
1.3 PERIODIC CHECK OF SERVO MOTOR	123
1.4 ORDER CODES OF REPLACEMENT COMPONENTS	125
APPENDIXES	
A. SERVO AMPLIFIER UNIT FRONT VIEW	129
B. PARAMETERS	130
B.1 CONTROLLED-AXIS PARAMETERS	131
B.2 COORDINATE SYSTEM AND STROKE LIMIT PARAMETERS	132
B.3 FEEDRATE PARAMETERS	135
B.4 ACCELERATION/DECELERATION CONTROL PARAMETERS	137
B.5 INPUT/OUTPUT SIGNALS PARAMETERS	139
B.6 SERVO PARAMETERS	143
B.7 DIGITAL SERVO STANDARD PARAMETER TABLE	154
C. DIAGNOSIS LISTS	155
C.1 SIGNALS SENT FROM CNC (HOST) TO SERVO UNIT	156
C.1.1 Peripheral Equipment Control Interface (DRC = 0)	156
C.1.2 Direct Command Interface (DRC = 1)	157
C.2 SIGNALS SENT FROM SERVO UNIT TO CNC (HOST)	158
C.2.1 Peripheral Equipment Control Interface (DRC = 0)	158
C.2.2 Direct Command Interface (DRC = 1)	159
C.3 SERVO POSITIONAL DEVIATION AMOUNT (SERVO UNIT)	160
C.4 ACCELERATION/DECELERATION DELAY AMOUNT (SERVO UNIT)	160
D. POWER MOTION MANAGER FUNCTIONS	161
D.1 OVERVIEW	162
D.2 I/O LINK CONNECTION	163
D.3 FUNCTION SELECTION AND TERMINATION	164
D.3.1 Selection	164
D.3.2 Function Selection Soft Key	164
D.3.3 Termination	164
D.3.4 Disabling the Power Motion Manager Functions	165

D.3.5	Parameter Setting	165
D.3.6	Restriction	165
D.4	FUNCTION OVERVIEW	166
D.4.1	Soft Key Status Transition Diagram	166
D.4.2	Screen Configuration	167
D.4.3	Operations of an Active Slave	169
D.5	FUNCTION DETAILS	170
D.5.1	System Configuration	170
D.5.2	Parameters	171
D.5.3	Diagnosis	173
D.5.4	Absolute Coordinate	173
D.5.5	Machine Coordinates	174
D.5.6	Alarms	174
E.	SERVO CHECK BOARD	175

I. START-UP PROCEDURE

1 OVERVIEW



This section describes the following topics, related to component confirmation and servo amplifier unit start-up:

- Configuration
- Start-up procedure
- Operation check method

2 CONFIGURATION



2.1 BASIC CONFIGURATION

The basic configuration is shown below. For details, refer to the "FANUC Servo Motor β Series Servo Descriptions (B-65232EN)."

Example of two servo amplifier units for two axes

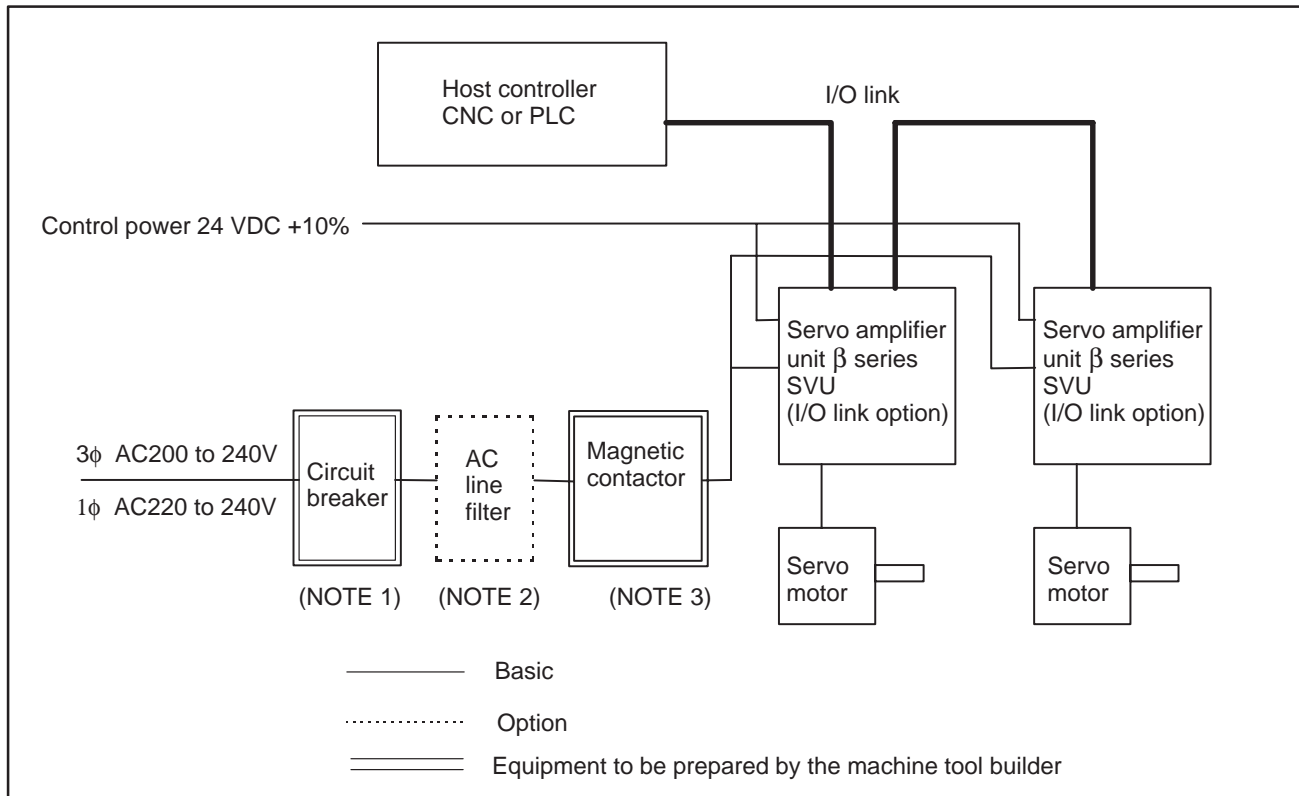

NOTE

- 1 The circuit breaker is used to protect the power cable, servo amplifier units, and so forth.
- 2 An AC line filter must be used to reduce the influence of harmonic noise on the power supply. When a power transformer (insulation type) is used because the input power supply voltage is outside the specified range, no AC line filter is required. If harmonic noise cannot be suppressed sufficiently to satisfy EMC requirements, use a commercially available noise filter.
- 3 The magnetic contactor is required to obtain the European CE marking.
- 4 At the power inlet of the power magnetics cabinet, install a surge absorber between lines and between each line and ground to protect the equipment from surge voltages caused by lightning.

2.2 MAJOR COMPONENTS

SVU

Name	Ordering code	Power PC board drawing number	Control PC board drawing number	Remarks
SVU-12	A06B-6093-H151	A20B-2100-0130	A20B-2201-0180	
SVU-20	A06B-6093-H152	A20B-2100-0131	A20B-2201-0180	

3

START-UP PROCEDURE



3.1 START-UP PROCEDURE (SUMMARY)

Start-up procedure

1. Check the specifications of the host controller (CNC or PLC), servo motor, detector, servo amplifier unit, and so forth.



2. Check for external damage and flaws.



3. Check the power supply voltage and rating. See Section 3.2.



4. Connect the ground wire, power supply cable, and power line. See Section 3.2.



5. Start the servo amplifier unit.



6. Start the host controller.



7. Set the parameters.

3.2 POWER SUPPLY CONNECTION

3.2.1 Checking the Power Supply Voltage and Capacity

- (1) Power supply voltage
Before connecting anything to the power supply, check the power supply voltage.

Item		Specifications
Input for motor power supply	Three-phase input	200 to 240 VAC. Allowable voltage fluctuation: +10%, -15% (NOTE) Frequency; 50 Hz, 60 Hz. Allowable frequency fluctuation: ± 2 Hz Voltage fluctuation at acceleration/deceleration must not exceed 7%.
	Single-phase input	220 to 240 VAC. Allowable voltage fluctuation: +10%, -15% (NOTE) Frequency; 50 Hz, 60 Hz. Allowable frequency fluctuation: ± 2 Hz Voltage fluctuation at acceleration/deceleration must not exceed 7%.
Single-phase input for control power supply		24 VDC $\pm 10\%$

NOTE

The allowable voltage fluctuations are not continuous fluctuations, but have a maximum duration of several minutes.

- (2) Power supply rating
- The power supply rating is the sum of the ratings of the individual servo motors.
 - Upon abrupt servo motor acceleration/deceleration, a capacity about two times greater than the continuous rating may be required momentarily. So, check the input voltage applied when several servo motors are accelerated or decelerated at the same time. Then, ensure that the voltage is 170 VAC or more for three-phase input, or 187 VAC or more for single-phase input.
 - For details, refer to Chapter 5 of Part III in the "FANUC Servo Motor β Series Descriptions (B-65232EN)."

3.2.2 Leakage Current and Ground Fault Interrupter

The driving circuit of the servo amplifier unit employs an IGBT-based pulse width modulation control method. So, a high-frequency leakage current flows to ground through the stray capacitance against the ground of the motor windings, power line, and amplifier. This leakage current may cause the leakage current protection relay or ground fault interrupter, installed on the power supply line, to malfunction. So, use an inverter-type ground fault interrupter designed to protect against such a malfunction.

(1) Motor leakage current

Use the following data for reference:

Motor model	Commercial frequency component
β 1 to β 6, α 0.5 (β 0.5) to α 2 α C3 to α C6	1.8mA
α C12	2.0mA

3.3 CONNECTION OF THE SEPARATE REGENERATIVE DISCHARGE UNIT

(1) Type

A06B-6093-H401	When naturally cooled (30 ohms/20 W)
A06B-6093-H402	When naturally cooled (30 ohms/100 W)

(2) Connection

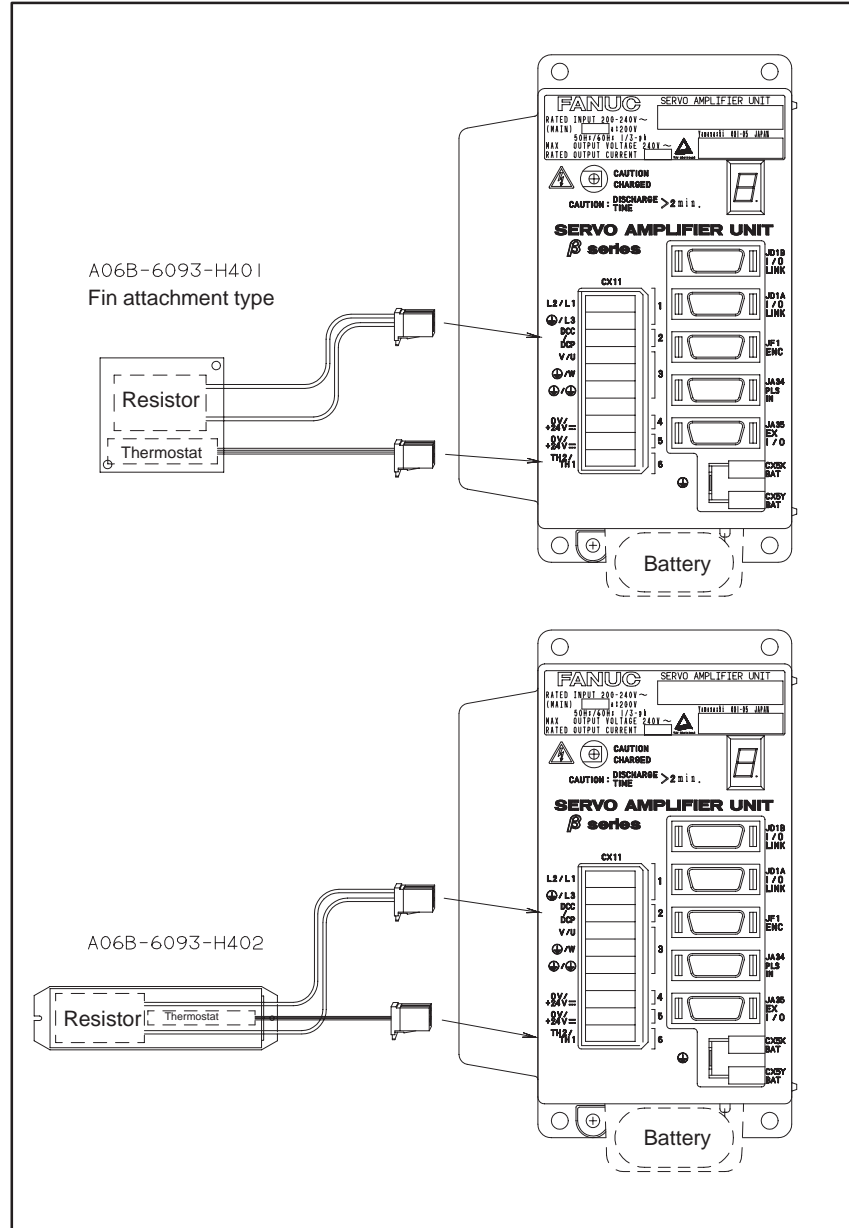

3.4 PARAMETER INITIALIZATION

- (1) Preparation prior to servo parameter initialization
Before servo parameter initialization, check the following:
1. Servo motor model (Example: β 6/2000)
 2. Amount of travel per motor rotation (Example: 10 mm/motor revolution)
 3. Number of pulses per motor rotation (Example: 10000 pulses/motor revolution)
A detection unit is determined from 2 and 3.
Detection unit = (Amount of travel per motor rotation)/
(number of pulses per motor rotation)
- (2) Procedure for servo parameter initialization
1. Turn on the power to the I/O link β unit.
 2. Turn on the power to the host controller in the emergency stop state.
 3. Perform parameter initialization from the host controller. Set values for the parameters listed below. (See 5 to 10.)

	Default	Parameter number
Motor number	None	No.30
CMR	2	No.32
Numerator for the number of pulses per revolution	10000	No.105
Denominator for the number of pulses per revolution	1	No.106
Direction of travel	111	No.31
Reference counter capacity	10000	No.180

4. Set initialization bit DGPR to 0.

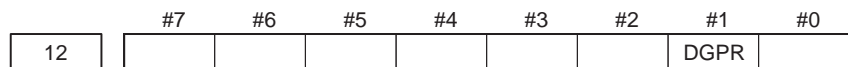

When this bit is set to 0, a power disconnection request alarm (alarm No. 0) is issued. However, 5 through 10 below can be set.

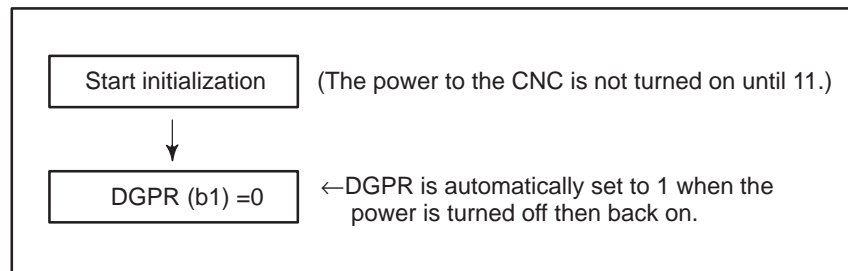

5. Set a motor type number.
In parameter No. 30, set the motor type number of the servo motor to be used.

Motor model	α C3/2000	α C6/2000	α C12/2000
Motor specification	0121	0126	0141
Motor type number	7	8	9
Motor model	α 1/3000	α 2/2000	α 2/3000
Motor specification	0371	0372	0373
Motor type number	61	46	62
Motor model	β 0.5/3000	β 1/3000	β 2/3000
Motor specification	0113	0031	0032
Motor type number	13	35	36
Motor model	β 3/3000	β 6/2000	-
Motor specification	0033	0034	-
Motor type number	33	34	-

6. Set CMR.
In parameter No. 32, set a factor by which the amount of travel specified in the CNC is multiplied for the servo system.

CMR = Command unit/detection unit

When CMR is 1 to 48	Setting = CMR x 2
---------------------	-------------------

When CMR is 1/2 to 1/27	Setting = 1/CMR + 100
-------------------------	-----------------------

Usually, CMR = 1. So, set 2.

7. Set the number of pulses per rotation.
By allowing the number of position feedback pulses from a pulse coder to be varied, a detection unit can easily be set with respect to the deceleration ratios and leads of the ball screws.

α and β pulse coder setting	
Numerator for the number of pulses per rotation (≤ 32767)	(Parameter No. 105)
Denominator for the number of pulses per rotation (≤ 32767)	(Parameter No. 106)

Example of setting: 10 μ m detection in a semi-closed loop

Ball screw lead	Number of position pulses required	Number of pulses per rotation Numerator/denominator
10 (mm/rev)	1000 (pulses/rev)	1000/1
20	2000	2000/1
30	3000	3000/1

Example of setting : 1/100 degree detection with a deceleration ratio of 10:1 for a rotation axis

Every time the motor makes one rotation, the table rotates through 360/10 degrees. For each degree of table rotation, 100 position pulses are required. The number of pulses per motor rotation is 360/10 x 100 = 3600 pulses, so set the following: Numerator = 3600, Denominator = 1

8. Set the direction of motor travel in parameter No. 31.

111	Clockwise as viewed from the pulse coder
-111	Counterclockwise as viewed from the pulse coder

9. Set the reference counter capacity. (Parameter No. 180)
Set the reference counter capacity when performing a reference position return operation based on the grid method. Set the number of position pulses per motor rotation, or set that number divided by an integer.

Example of setting: α and β pulse coders, semi-closed loop (1 μ m detection)

Ball screw lead	Number of position pulses required	Reference counter	Grid width
10 mm/revolution	10000 pulses/revolution	10000	10mm
20	20000	20000	20mm
30	30000	30000	30mm

10. Turn the power to the CNC off, then back on again.
This completes servo parameter initialization.
11. When using an α or β pulse coder as an absolute pulse coder, use the procedure described below.
- 1) Set the following parameter, then turn off the power to the CNC.

	#7	#6	#5	#4	#3	#2	#1	#0
11	APCX							

APCX (b7) An absolute position detector is:

0 : Not used

1 : Used

- 2) Check the connection of the pulse coder battery, then turn on the power to the CNC.
- 3) Absolute position communication is performed, then a reference position return request is indicated.
- 4) Rotate the servo motor through one or more rotations by jogging.
- 5) Turn the power to the host CNC and I/O link β off, then back on again.
- 6) Absolute position communication is performed, then a reference position return request is indicated.
- 7) Perform reference position return.

4

OPERATION CHECK METHOD



4.1 CHECK PROCEDURE

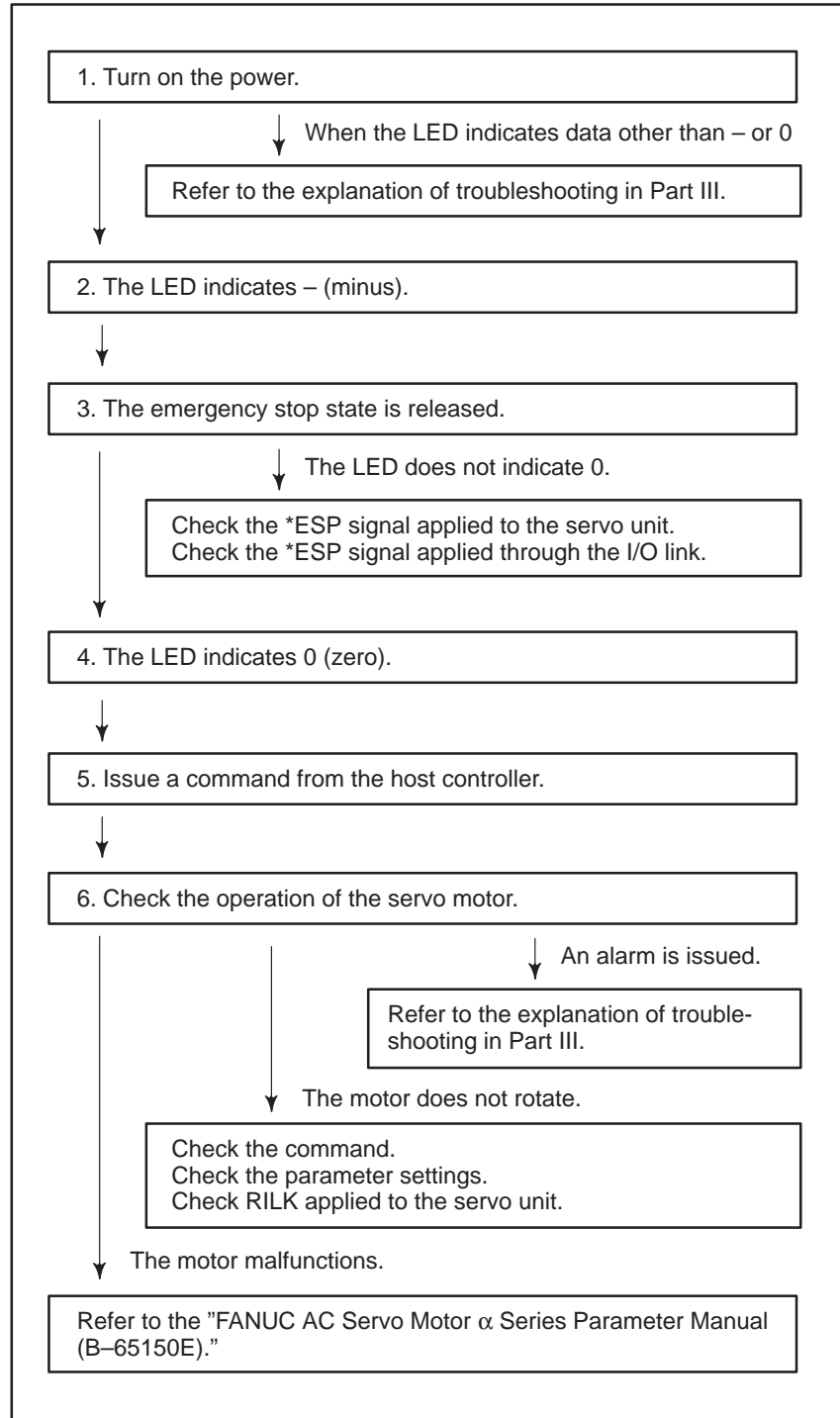

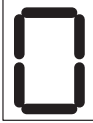
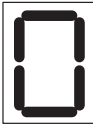



Table 4.1 LED Indications and Meanings

LED indication	State	Description
	Amplifier not ready	This indicates that control power (+24 VDC) is supplied. No alarm is issued, but the motor is not activated.
	Amplifier ready	This indicates that the motor is activated, and that commands can now be accepted.
 Blinking	Command being executed	This indicates that an accepted command is now being executed.
 Blinking	Parameters being loaded	This indicates that parameters are being loaded in a batch from the power motion manager or through the RS-232C interface.
Indication other than the above	Alarm	An alarm is issued. For information about alarms, see the explanation of troubleshooting in Part III.

II. HANDLING

1 OVERVIEW



1.1 SERVO UNIT INTERFACE

The servo unit is connected to a host unit such as a CNC via 128 DI and 128 DO points of the I/O link. The ladder program on the host unit sends move commands to the servo unit and monitors its status, via this interface.

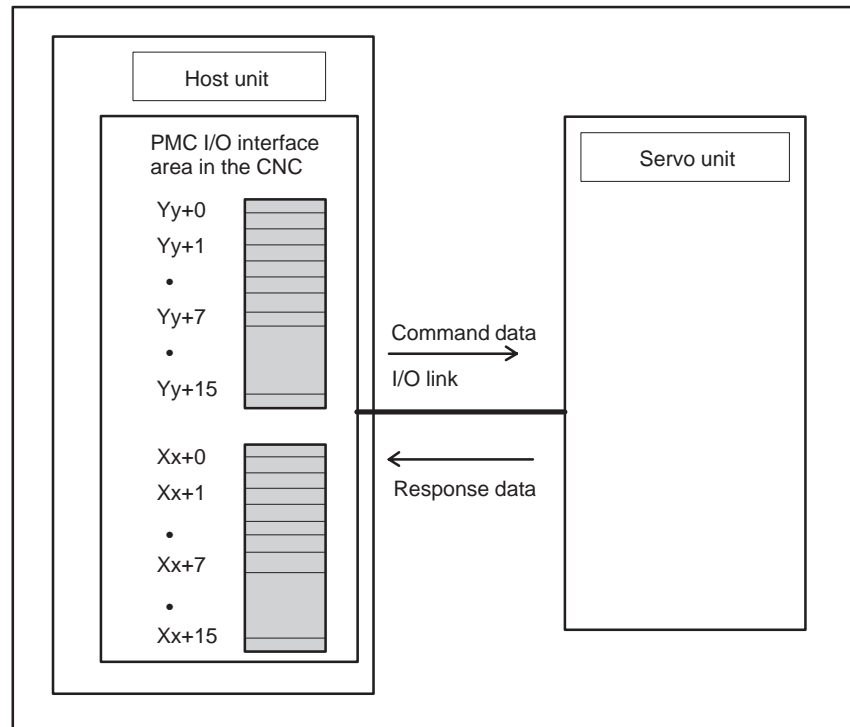

1.2 I/O LINK INTERFACE AREA

The interface area used to transfer data via the I/O link is divided into two sections: A signal area for handling reset and alarm signals, and a command code area for handling move commands and status monitor command code.

The host unit can directly read– and write–access the signal area. So it can be used to select the interface mode, start/stop operations, and monitor for alarm conditions.

The command code area can be used to issue commands to servo amplifiers by combining function code and command data. For example, it is possible to send absolute/incremental move command and reference position return move command blocks, and receive the current position data.

1.3 INTERFACE

Interfaces are used to transfer data to and from the servo unit. Essentially, there are two operation modes: Peripheral equipment control interface and direct command interface. The mode to be used is selected by the DRC signal in the signal area.

1.3.1 Peripheral Equipment Control Interface

This interface offers a high degree of compatibility with the peripheral equipment control functions of the Power Mate-E. It is provided with commands that can be used to control the peripheral equipment of machine tools. It enables the implementation of a series of positioning operations, such as axis clamp/unclamp, with a single command. This interface is useful if a ladder program, created based on this interface, is already available.

1.3.2 Direct Command Interface

This interface is used to implement a positioning operation with a single command, unlike peripheral equipment control, in which a single command can perform multiple operations. Besides a positioning command, this interface offers commands such as wait, parameter read/write, and diagnosis data read commands, enabling a wide range of operations can be implemented.

The two interface modes can be switched during operation. Interface switching causes the meaning of signals to be changed, requiring complicated ladder program logic. So, it is recommended that the interface mode not be changed during a servo unit control sequence.

1.3.3 Interface Switching

Either peripheral equipment control or direct command interface mode is available depending on the situation. Usually, interface switching is not performed while the power is on. When necessary, however, the host can switch the interface by issuing a DRC signal.

When the DRC signal is 0, the peripheral equipment control interface is selected. When it is 1, the direct command interface is selected.

When the DRCO signal is 0, response data received from the servo unit indicates the peripheral equipment control interface. When it is 1, the response data indicates the direct command interface.

DRC signal switching must be performed during a reset state. Signal switching causes the meaning of a signal in use to be changed. Be careful when a command is being issued or axis movement is occurring, as signal switching may result in unexpected behavior.

Once the DRC signal is switched, defer issuing a command until one scan after the DRCO signal is switched. If the DRC signal is inverted again before the DRCO signal is switched, it may become impossible to exchange data with the servo amplifier normally. Before inverting the DRC signal again, wait for at least one scan after the DRCO signal is switched.

1.4 CAUTIONS ON USING THE POWER MOTION MANAGER

If the power motion manager function is used simultaneously when the direct command interface is selected, they share the response data area. Response data area sharing requires the identification of the interface type that corresponds to the response data received from the servo unit, to accept only the response data related to the PMC of the host. The response data can be identified according to its USR1.

If USR1 is 0, the response data is related to the PMC of the host and is accepted. If it is 1, the response data is for the power motion manager, and is ignored by the PMC.

2

SIGNAL DESCRIPTIONS



2.1 DO/DO SIGNALS

A host unit such as a CNC is connected to the servo unit via 128 DI and 128 DO points of the I/O link.

CAUTION

I/O link interface signal assignment differs between the peripheral equipment control and direct command interfaces.

2.1.1 Peripheral Equipment Control Interface

Locations Yy+0, Yy+1, and Yy+7 are allocated as the DO signal area, while locations Xx+0, Xx+1, Xx+2, and Xx+7 are allocated as the DI signal area. To control the servo unit, it is necessary to turn on or off directly those signals that are assigned to these areas of read them.

For the command code area, the function code and command data 1 are assigned to location Yy+2, and command data 2 is assigned to locations Yy+3 to Yy+6. Command issue to the servo unit must be done using these locations. Response data is assigned to locations Xx+3 to Xx+6. So, response data sent in response to commands can be received at these locations.

CNC (host) → Servo unit (DRC=0)

	#7	#6	#5	#4	#3	#2	#1	#0
Yy+0	ST	UCPS2	-X	+X	DSAL	MD4	MD2	MD1
Yy+1		IGNVRY	DRC		*ILK	SVFX	*ESP	ERS
Yy+2	Function code				Command data 1			
Yy+3	Command data 2							
Yy+4	Command data 2							
Yy+5	Command data 2							
Yy+6	Command data 2							
Yy+7	RT	DRN	ROV2	ROV1	*OV8	*OV4	*OV2	*OV1
Yy+8	(Unused)							
Yy+9	(Unused)							
Yy+10	(Unused)							
Yy+11	(Unused)							
Yy+12	(Unused)							
Yy+13	(Unused)							
Yy+14	(Unused)							
Yy+15	(Unused)							

Servo unit → CNC (host) (DRC=0)

	#7	#6	#5	#4	#3	#2	#1	#0
Xx+0	OPC4	OPC3	OPC2	OPC1	INPX	SUPX	IPLX	DEN2
Xx+1	OP	SA	STL	UCPC2			DRCO	
Xx+2	MA	AL	DSP2	DSP1	DSALO		RST	ZPX
Xx+3	Response data							
Xx+4	Response data							
Xx+5	Response data							
Xx+6	Response data							
Xx+7		SVERX		PSG2	PSG1	MVX	APBAL	MVDX
Xx+8	Unusable (Power motion manager response area)							
Xx+9	Unusable (Power motion manager response area)							
Xx+10	Unusable (Power motion manager response area)							
Xx+11	Unusable (Power motion manager response area)							
Xx+12	Unusable (Power motion manager response area)							
Xx+13	Unusable (Power motion manager response area)							
Xx+14	Unusable (Power motion manager response area)							
Xx+15	Unusable (Power motion manager response area)							

See Section 2.3 for details of the signals. Section 3.3 explains the function code, command data, and response data.

2.1.2 Direct Command Interface

Locations Yy+0 to Yy+3 are allocated as the DO signal area, while locations Xx+0 to Xx+3 are allocated as the DI signal area. To control the servo unit, turn on or off directly those signals that are assigned to these areas or read them.

For the command code area, command data for direct commands is assigned to locations Yy+4 to Yy+15. Command issue to the servo unit must be done using these locations. Response data for direct commands is assigned to locations Xx+4 to Xx+15. So, the response data sent in response to the direct command interface can be received at these locations.

CNC (host) → Servo unit (DRC=1)

	#7	#6	#5	#4	#3	#2	#1	#0
Yy+0	ST		-X	+X		MD4	MD2	MD1
Yy+1		IGNVRY	DRC	WFN	*ILK	SVFX	*ESP	ERS
Yy+2	RT	DRN	ROV2	ROV1	*OV8	*OV4	*OV2	*OV1
Yy+3	INPF							
Yy+4	EBUF	EOREND						ECNT
Yy+5	Direct command (function code)							
Yy+6	Direct command (command data 1)							
Yy+7	Direct command (command data 2)							
Yy+8	Direct command (command data 3)							
Yy+9	Direct command (command data 4)							
Yy+10	Direct command (command data 5)							
Yy+11	Direct command (command data 6)							
Yy+12	Direct command (command data 7)							
Yy+13	Direct command (command data 8)							
Yy+14	Direct command (command data 9)							
Yy+15	Direct command (command data 10)							

Servo unit → CNC (host) (DRC=1)

	#7	#6	#5	#4	#3	#2	#1	#0
Xx+0					INPX	SUPX	IPLX	DEN2
Xx+1	OP	SA	STL				DRCO	WAT
Xx+2	MA	AL					RST	ZPX
Xx+3	INPFO	SVERX		PSG2	PSG1	MVX	APBAL	MVDX
Xx+4	EBSY	EOSTB	ECF		USR1	EOPC	DAL	ECONT
Xx+5	Direct command (function code)							
Xx+6	Reserved				Execution result			
Xx+7	Direct command (response data 1)							
Xx+8	Direct command (response data 2)							
Xx+9	Direct command (response data 3)							
Xx+10	Direct command (response data 4)							
Xx+11	Direct command (response data 5)							
Xx+12	Direct command (response data 6)							
Xx+13	Direct command (response data 7)							
Xx+14	Direct command (response data 8)							
Xx+15	Direct command (response data 9)							

See Section 2.3 for details of the signals. Section 4.4 explains the function number, command data, and response data.

2.2 SIGNALS (LISTED IN GROUPS)

The following lists not only signals transferred via the I/O link interface but also direct input/output signals such as *ESP, *-OT, *+OT, and *RILK.

Each listed address is based on the I/O link assignment address of each slave of the host.

Group	Signal name	Symbol	Address		Reference
			Peripheral equipment	Direct command	
1	Preparation completion signal	MA	X2#7		2.3.1
	Servo preparation completion signal	SA	X1#6		2.3.1
2	Emergency stop signal	*ESP	Y1#1		2.3.2
	External reset signal	ERS	Y1#0		2.3.2
	Reset in-progress signal	RST	X2#1		2.3.2
3	Alarm signal	AL	X2#6		2.3.3
	Absolute pulse coder battery alarm signal	APBAL	X7#1	X3#1	2.3.3
4	Mode selection signal	MD4,MD2,MD1	Y0#0 to Y0#2		2.3.4
5	Feed axis and direction selection signal	+X	Y0#4		2.3.5
		-X	Y0#5		2.3.5
6	Remaining travel in-range signal	DEN2	X0#0		2.3.6
	Distribution pulse signal	IPLX	X0#1		2.3.6
	Acceleration/deceleration pulse signal	SUPX	X0#2		2.3.6
	In-position signal	INPX	X0#3		2.3.6
	Servo positional deviation monitor signal	SVERX	X7#6	X3#6	2.3.6
	Axis movement in-progress signal	MVX	X7#2	X3#2	2.3.6
	Movement direction signal	MVDX	X7#0	X3#0	2.3.6
	Area signal	PSG2 to PSG1	X7#3	X3#3	2.3.6
X7#4			X3#4	2.3.6	
7	Feedrate override signal	*OV1 to *OV8	Y7#0– Y7#3	Y2#0– Y2#3	2.3.7
	Manual rapid traverse selection signal	RT	Y7#7	Y2#7	2.3.7
	Rapid traverse override signal	ROV2 to ROV1	Y7#4	Y2#4	2.3.7
			Y7#5	Y2#5	2.3.7
8	Interlock signal	*ILK	Y1#3		2.3.8
9	Reference position return completion signal	ZPX	X2#0		2.3.9
10	Automatic operation start signal	ST	Y0#7		2.3.10
	Automatic operation start in-progress signal	STL	X1#5		2.3.10
	Automatic operation signal	OP	X1#7		2.3.10
	Dry run signal	DRN	Y7#6	Y2#6	2.3.10
11	Unclamp command signal	UCPC2	X1#4	—	2.3.11
	Clamp/unclamp state output signal	UCPS2	Y0#6	—	2.3.11
12	Servo-off signal	SVFX	Y1#2		2.3.12
	V READY OFF alarm ignore signal	IGNVRY	Y1#6		2.3.12

Group	Signal name	Symbol	Address		Reference
			Peripheral equipment	Direct command	
13	Operation completion signal	OPC1,OPC2, OPC3,OPC4	X0#4 to X0#7	—	2.3.13
	Function code	CMD CODEP	Y2#4 to Y2#7	—	2.3.13
	Command data 1	CMD DATA1	Y2#0 to Y2#3	—	2.3.13
	Command data 2	CMD DATA2	Y3 to Y6	—	2.3.13
	Response data	ANS DATAP	X3 to X6	—	2.3.13
	Response data check signal	DSP1,DSP2	X2#4,X2#5	—	2.3.13
	Alarm output command signal	DSAL	Y0#3	—	2.3.13
	Alarm output state check signal	DSALO	X2#3	—	2.3.13
14	Function code command strobe signal	EBUF	—	Y4#7	2.3.14
	Function code command read completion signal	EBSY	—	X4#7	2.3.14
	Function code	CMD CODE	—	Y5	2.3.14
	Command data	CMD DATA	—	Y6 to Y15	2.3.14
	Response data	ANS DATA	—	X6 to X15	2.3.14
	Continuously output data signal	EOPC	—	X4#2	2.3.14
	Response data readable signal	EOSTB	—	X4#6	2.3.14
	Response data read completion signal	EOREND	—	Y4#6	2.3.14
	Command continuation notification signal	ECNT	—	Y4#0	2.3.14
	PMM data signal	USR1	—	X4#3	2.3.14
	Response data continuation notification signal	ECONT	—	X4#0	2.3.14
	Function code command completion notification signal	ECF	—	X4#5	2.3.14
	Alarm signal	DAL	—	X4#1	2.3.14
	Wait signal	WAT	—	X1#0	2.3.14
	Wait completion signal	WFN	—	Y1#4	2.3.14
	Memory registration signal	INPF	—	Y3#7	2.3.14
	Memory registration in-progress signal	INPFO	—	X3#7	2.3.14
Interface switch signal	DRC	—	Y1#5	2.3.14	
Interface status notification signal	DRCO	—	X1#1	2.3.14	
15	Emergency stop signal	*ESP	Direct input		2.3.15
	Overtravel signal	*-OT	Direct input		2.3.15
		*+OT	Direct input		2.3.15
	High-speed interlock signal	*RILK	Direct input		2.3.15

2.3 SIGNAL DETAILS

2.3.1 Preparation Completion

(1) Preparation completion signal MA

[Classification]

Input signal <X2#7> (common to both the peripheral equipment and direct command interfaces)

[Function]

This signal indicates that the servo unit is ready to operate.

[Input condition]

The signal becomes 1 when:

1. Self-diagnosis in the servo unit completes normally when the power is switched on.

The signal becomes 0 when:

1. The power to the servo unit is switched off.
2. A control unit error such as a CPU or memory failure is detected.

(2) Servo preparation completion signal SA

[Classification]

Input signal <X1#6> (common to both the peripheral equipment and direct command interfaces)

[Function]

This signal indicates that the servo unit is ready to operate. Conversely, if this signal is not issued, the servo unit is not operating.

[Input condition]

The signal becomes 1 when:

1. Self-diagnosis in the servo system completes normally when the power to the control unit is switched on.
2. A servo alarm (if any has occurred) is reset.
3. An emergency stop condition (if any has occurred) is reset.

The signal becomes 0 when:

1. The power to the control unit is switched off.
2. A servo alarm condition is detected.
3. An emergency stop is effected.

CAUTION

In the servo-off state, the SA signal remains at 1 unless a condition which resets it to 0 occurs.

2.3.2 Reset and Emergency Stop

- (1) Emergency stop signal *ESP

[Classification]

Output signal <Y1#1> (common to both the peripheral equipment and direct command interfaces)

[Function]

This signal brings the control unit to an emergency stop.

[Operation]

When the signal becomes 0, the control unit operates as follows:

1. The control unit decelerates axis movement to a stop immediately.
2. A reset is applied after the stop.
3. When the emergency stop signal is 0, the servo preparation completion signal SA is also 0, because the servo system is not operating. If axis movement occurs while the servo system is not operating, the amount of movement is reflected in the current position coordinates held in the control unit (follow-up).
4. While the emergency stop signal is 0, jog and function code commands cannot be issued.

- (2) External reset signal ERS

[Classification]

Output signal <Y1#0> (common to both the peripheral equipment and direct command interfaces)

[Function]

This signal resets the servo unit.

[Operation]

When the signal becomes 1, the servo unit operates as follows:

1. The servo unit immediately decelerates axis movement to a stop.
2. After a stop, the servo unit is reset, then the following are canceled:
 - Function code commands being executed, buffered, and sent as an input signal.
 - Alarm conditions (if any).
3. While the external reset signal is 1, jog and function code commands cannot be issued.

- (3) Reset in-progress signal RST

[Classification]

Input signal <X2#1> (common to both the peripheral equipment and direct command interfaces)

[Function]

This signal indicates that the control unit is being reset.

[Input condition]

The signal becomes 0 when:

1. A reset is completed.

The signal becomes 1 when:

1. A reset is in progress.

That is, the external reset signal ERS ((2) in Section 2.3.2) is 1, or the emergency stop signal *ESP ((1) in Section 2.3.2) is 0.

2.3.3 Alarm

(1) Alarm signal AL

[Classification]

Input signal <X2#6> (common to both the peripheral equipment and direct command interfaces)

[Function]

This signal indicates that the servo unit is in an alarm state.

[Input condition]

The signal becomes 1 when:

1. The servo unit enters an alarm state.

The following alarms can occur in the servo unit.

- 1) P/S alarm
- 2) Pulse coder alarm
- 3) Servo alarm
- 4) Overtravel alarm

The signal becomes 0 when:

1. The servo unit is released from an alarm state by a reset.

Some alarms occur again after they are reset, unless their cause is removed. So, the AL signal is issued again immediately. In this case, the AL signal may become 0 for a moment.

(2) Absolute pulse coder battery alarm signal APBAL

[Classification]

Input signal <X7#1> (peripheral equipment control interface)
<X3#1> (direct command interface)

[Function]

This signal indicates that the batteries of the absolute pulse coder require replacement.

[Input condition]

The signal becomes 1 when:

1. The absolute pulse coder battery voltage is low.

The signal becomes 0 when:

1. The batteries are replaced, and the battery voltage becomes higher than or equal to the rating.

This alarm will occur again after it is reset, unless the batteries are replaced. So, the APBAL signal is immediately issued again. In this case, the APBAL signal may become 0 for a moment.

2.3.4 Mode Selection

- (1) Mode selection signal MD1, MD2, and MD4

[Classification]

Output signal <Y0#0 to Y0#2> (common to both the peripheral equipment and direct command interfaces)

[Function]

This signal selects an operation mode.

[Operation]

The signal is a code signal consisting of three bits: MD1, MD2, and MD4. The code signal selects one of three modes: automatic operation (AUTO), handle feed (HANDLE), or jog (JOG), according to the combination of these bits.

MD1	MD2	MD4	Description
1	0	0	Automatic operation (AUTO)
0	0	1	Handle feed (HANDLE)
1	0	1	Jog feed by +X and -X (JOG)

CAUTION

Do not switch the operation mode during automatic operation. Stop automatic operation before switching the operation mode.

NOTE

See Chapter 5 for details of handle feed.

2.3.5 Jog Feed

- (1) Feed axis and direction selection signals +X and -X

[Classification]

Output signal <Y0#4, #5> (common to both the peripheral equipment and direct command interfaces)

[Function]

These signals select the direction in which jog feed movement (rotation) is to be performed, and cause it to be performed in the selected direction.

[Operation]

The signals are valid when jog feed (JOG) is selected. They indicate the direction of feed. After JOG mode is selected, changing +X or -X, whichever is desired, from 0 to 1 causes and keeps movement in the corresponding direction at a feedrate specified by the override signals *OV1 to *OV8 ((1) of Section 2.3.7) or the manual rapid traverse selection signal RT ((2) of Section 2.3.7), provided the signal is 1.

CAUTION

- 1 Simultaneously setting +X and -X to 1 results in neither direction being selected (equivalent to when both are 0).
- 2 If a feed axis selection signal becomes 1 before the jog feed selection signal (JOG) becomes 1, these signals are ignored. If the JOG signal is 1, it must be reset to 0 before the feed axis selection signal is set. The servo unit begins feeding when the JOG signal rises.

2.3.6 Status Signals

(1) Remaining travel in-range signal DEN2

[Classification]

Input signal <X0#0> (common to both the peripheral equipment and direct command interfaces)

[Function]

This signal indicates that, in the servo unit, the number of axis move command distribution pulses that have not been used for axis movement (residual movement amount) is smaller than a parameter-specified value.

[Input condition]

The signal becomes 1 when:

1. The number of axis move command distribution pulses that have not been used for axis movement (residual movement amount) is smaller than a parameter-specified value.

The signal becomes 0 when:

1. The number of axis move command distribution pulses that have not been used for axis movement (residual movement amount) is larger than a parameter-specified value.
2. When the value of a parameter for the remaining travel in-range signal is 0.

CAUTION

- 1 The DEN2 signal remains 0 during jog feed (JOG).
- 2 The DEN2 signal maintains its current state until another move command is issued.

(2) Distribution pulse signal IPLX

[Classification]

Input signal <X0#1> (common to both the peripheral equipment and direct command interfaces)

[Function]

This signal indicates that the servo unit has axis move command distribution pulses that have not been used for axis movement (residual movement amount).

[Input condition]

The signal is 1 when:

1. There are axis move command distribution pulses that have not been used for axis movement (residual movement amount).

The signal is 0 when:

1. There is no axis move command distribution pulse that has not been used for axis movement (residual movement amount).

CAUTION

The IPLX signal is valid while jog feed (JOG) mode is set.

(3) Acceleration/deceleration pulse signal SUPX

[Classification]

Input signal <X0#2> (common to both the peripheral equipment and direct command interfaces)

[Function]

This signal indicates that the servo unit has accumulated pulses in the acceleration/deceleration control section.

[Input condition]

The signal is 1 when:

1. Axis movement distribution pulses are accumulated in the acceleration/deceleration control section.

The signal is 0 when:

1. No axis movement distribution pulses are accumulated in the acceleration/deceleration control section.

(4) In-position signal INPX

[Classification]

Input signal <X0#3> (common to both the peripheral equipment and direct command interfaces)

[Function]

This signal indicates that the controlled axis is in position (has reached the specified value).

[Input condition]

The signal is 1 when:

1. There is no acceleration/deceleration delay (accumulated pulses) for the controlled axis, and the servo positional deviation is within a parameter-specified range.

The signal is 0 when:

1. There is an acceleration/deceleration delay (accumulated pulses) for the controlled axis, or
2. The servo positional deviation falls outside a parameter-specified range.

(5) Servo positional deviation monitor signal SVERX

[Classification]

Input signal <X7#6> (peripheral equipment control interface)

Input signal <X3#6> (direct command interface)

[Function]

This signal indicates that, in the servo unit, the amount of servo positional deviation has exceeded a parameter-specified value.

[Input condition]

The signal is 1 when:

1. The servo positional deviation amount is larger than a parameter-specified value.

The signal is 0 when:

1. A parameter-specified value for the servo positional deviation amount is 0, or
2. The servo positional deviation amount is within a parameter-specified range.

(6) Axis movement in-progress signal MVX

[Classification]

Input signal <X7#2> (peripheral equipment control interface)

Input signal <X3#2> (direct command interface)

[Function]

The signal indicates that movement along the controlled axis is being performed.

[Input condition]

The signal becomes 1 when:

1. Controlled axis movement begins.

The signal becomes 0 when:

1. Controlled axis movement ends, and the controlled axis enters the in-position state.

CAUTION

- 1 The MVX signal is valid while jog feed (JOG) mode is set.
- 2 The MVX signal is output even during follow-up, provided the necessary conditions are satisfied.

(7) Movement direction signal MVDX

[Classification]

Input signal <X7#0> (peripheral equipment control interface)

Input signal <X3#0> (direct command interface)

[Function]

The servo unit indicates the movement direction of its controlled axis.

[Input condition]

The signal becomes 1 when:

1. Controlled axis movement in the negative direction begins.

The signal is 0 when:

1. Controlled axis movement in the positive direction begins.

CAUTION

- 1 The MVDX signal is valid while jog feed (JOG) mode is set.
- 2 The MVDX signal maintains its current state during a stop. It does not become 0 even upon a stop after movement in the negative direction.
- 3 The servo unit outputs the MVX signal even during follow-up, provided the necessary condition is satisfied.

(8) Area signals PSG1 and PSG2

[Classification]

Input signals PSG1<X7#3> and PSG2<X7#4>
(peripheral equipment control interface)

PSG1<X3#3> and PSG2<X3#4>
(direct command interface)

[Function]

The servo unit indicates that the current machine coordinates are within a parameter-specified range, using two code signal outputs.

[Input condition]

If a parameter is set up as shown below, PSG1 and PSG2 are output in the respective sections, as shown below.

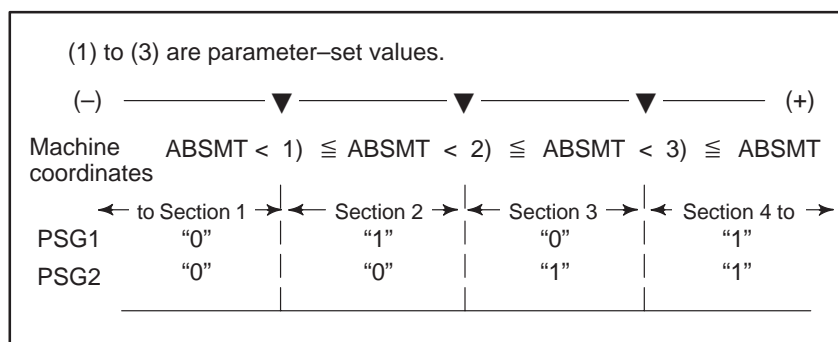
**CAUTION**

The servo unit outputs the PSG1 and PSG2 signals even during follow-up, provided the necessary condition is satisfied.

2.3.7 Feedrate

- (1) Override signals *OV1 to *OV8

[Classification]

Output signal <Y7#0 to Y7#3> (peripheral equipment control interface)

<Y2#0 to Y7#3> (direct command interface)

[Function]

The host applies override to jog feed and cutting feedrates.

[Operation]

Four binary code signals are provided. They correspond to the override values listed below.

*OV8	*OV4	*OV2	*OV1	Override value (%)
1	1	1	1	0
1	1	1	0	10
1	1	0	1	20
1	1	0	0	30
1	0	1	1	40
1	0	1	0	50
1	0	0	1	60
1	0	0	0	70
0	1	1	1	80
0	1	1	0	90
0	1	0	1	100
0	1	0	0	110
0	0	1	1	120
0	0	1	0	130
0	0	0	1	140
0	0	0	0	150

Actual jog feed and automatic cutting feedrates are obtained by multiplying the respective specified values by the override values.

- (2) Manual rapid traverse selection signal RT

[Classification]

Output signal <Y7#7> (peripheral equipment control interface)
<Y2#7> (direct command interface)

[Function]

The host selects rapid traverse for jog feed.

[Operation]

The RT signal is valid when jog feed mode (JOG) is selected. When the signal is 1, jog feed is performed at a rapid traverse rate. Under this condition, setting a feed axis and direction selection signal (+X or -X) to 1 starts rapid traverse in the specified direction. If jog feed is selected, a feed axis and direction selection signal (+X or -X) is 1, and an override signal is valid, setting the RT signal to 1 starts rapid traverse. Resetting the RT signal to 0 resumes normal feed.

- (3) Rapid traverse override signals ROV1 and ROV2

[Classification]

Output signal <Y7#4 and Y7#5> (peripheral equipment control interface)
<Y2#4 and Y#5> (direct command interface)

[Function]

The host specifies override for rapid traverse.

[Operation]

The following table lists the override amounts.

ROV2	ROV1	Override amount
0	0	100%
0	1	50%
1	0	25%
1	1	FO

NOTE

FO is a value specified in parameter No. 061.

2.3.8 Interlock

- (1) Interlock signal *ILK

[Classification]

Input signal <Y1#3> (common to both the peripheral equipment and direct command interfaces)

[Function]

The host stops sending jog feed and function code commands.

[Input condition]

When the *ILK signal is 0, the host resets jog feed and function code command signals to 0 to decelerate and stop controlled axis feed. Movement commands remain valid when the *ILK signal is 0. When it becomes 1, movement is resumed immediately. No command other than a move command is affected.

CAUTION

The interlock signal is valid when jog feed (-X or +X) is being performed based on the jog feed selection signal (JOG).

2.3.9 Reference Position Return

- (1) Reference position return completion signal ZPX

[Classification]

Input signal <X2#0> (common to both the peripheral equipment and direct command interfaces)

[Function]

The servo unit indicates that it is at the reference position.

[Input condition]

The signal becomes 1 when:

1. Manual reference position return is completed, and the servo unit enters the in-position state.
2. Function code command-based reference position return is completed, and the servo unit enters the in-position state.

The signal becomes 0 when:

1. The servo unit moves out of the reference position.

2.3.10 Automatic Operation

- (1) Automatic operation start signal ST

[Classification]

Input signal <Y0#7> (common to both the peripheral equipment and direct command interfaces)

[Function]

The host starts function code commands, such as part of peripheral equipment control ATC operations and point positioning. Specifically, the host issues a direct command to start 32-block buffering.

[Operation]

When the ST signal is set to 1 then reset to 0 again, the servo unit begins operating. Section 3.3.1 explains the function codes for which the ST signal is valid in peripheral equipment control.

CAUTION

It is also possible to start operation at the rising edge (from off to on) of the ST signal as specified by the STON parameter (bit 7 of parameter No. 003).

- (2) Automatic operation start in-progress signal STL

[Classification]

Input signal <X1#5> (common to both the peripheral equipment and direct command interfaces)

[Function]

This signal indicates that automatic operation has been started.

[Input condition]

The signal becomes 1 when a command to start automatic operation is issued. It becomes 0 when automatic operation stops.

- (3) Automatic operation signal OP

[Classification]

Input signal <X1#7> (common to both the peripheral equipment and direct command interfaces)

[Function]

This signal indicates that a series of automatic operations is in progress.

[Input condition]

The signal becomes 1 when a command to start automatic operation is issued. The signal remains set to 1 even after automatic operation stops. It becomes 0 upon the occurrence of a reset.

- (4) Dry run signal DRN

[Classification]

Output signal <Y7#6> (peripheral equipment control interface)
<Y2#6> (direct command interface)

[Function]

Dry run is valid during automatic operation (AUTO mode). During dry run, a feedrate command issued during automatic operation is ignored, and a manual-feed feedrate determined by override signals *OV1 to *OV8 ((1) of Section 2.3.7) is used. Dry run is also valid for rapid traverse. When the RT signal ((2) of Section 2.3.7) is set to 1 during dry run, the "rapid traverse rate" and the "maximum manual-feed feedrate" are used for the rapid traverse and cutting feed blocks, respectively. When the RT signal is reset to 0, the "same rate as the manual-feed feedrate" is resumed.

[Operation]

Setting the DRN signal to 1 causes the system to enter the dry run state. Resetting it to 0 resumes the feed rate specified during automatic operation.

2.3.11

Clamp and Unclamp (for the Peripheral Equipment Control Interface Only)

- (1) Unclamp command signal UCPC2

[Classification]

Input signal <X1#4>

[Function]

The host is responsible for clamping and unclamping the machine. The servo unit issues this signal to request the host to clamp/unclamp the machine when a peripheral equipment control function code command is executed.

[Input condition]

The signal is set to 1 when a request is issued to the host to unclamp the machine. It is reset to 0 when a request is issued to the host to clamp the machine. The servo unit sets the UCPC2 signal to 1 when it starts executing commands with function codes 0 and 2 to 6. When the move command is terminated, the UCPC2 signal is reset to 0. See the timing chart for the function codes for peripheral equipment control.

CAUTION

The UCPC2 signal is valid when the NCLP parameter (bit 1 of parameter No. 003) is 0.

- (2) Clamp/unclamp state output signal UCPS2

[Classification]

Output <Y0#6>

[Function]

When the servo unit requests clamping/unclamping of the machine, using the UCPC2 signal, the host actually clamps/unclamps the machine. Upon the completion of clamping/unclamping, it reports it to the servo unit, which then proceeds to the next processing.

[Operation]

The signal is set to 1 when the machine is unclamped. When it is clamped, the signal is reset to 0. See the timing chart for the function codes for peripheral equipment control.

CAUTION

The UCPS2 signal is valid when the NCLP parameter (bit 1 of parameter No. 003) is 0.

2.3.12

Servo-off

- (1) Servo-off command signal SVFX

[Classification]

Output signal <Y1#2> (common to both the peripheral equipment and direct command interfaces)

[Function]

The host turns off the servo circuit for a controlled axis, that is, shuts off the current to the servo motor of the controlled axis. This disables positioning control. Position detection continues, however. So, the current position will not be lost.

[Operation]

The servo motor remains off while the signal is 1. If the machine is moved by the application of external force, its coordinates are shifted, because positioning control does not work during the servo-off state. How the shifted machine coordinates are handled can be selected by a parameter, as follows:

1. The machine coordinate shift is recorded in an error counter. When the servo-off signal becomes 0, the machine moves to cancel out the error recorded in the error counter.
2. Follow-up is performed. The machine coordinate shift is regarded as being the result of a command, and the control unit adjusts its current position data so that the error counter becomes 0. With this method, the machine remains in a shifted position even after the servo-off signal becomes 0. However, the machine moves to the correct position the next time an absolute command is issued, because the control unit has information about the correct position.

[Use]

Generally, method (1) above is used to prevent excessive current flowing through the servo motor when it is clamped mechanically with a force stronger than the servo motor can generate. Usually, the host keeps the interlock signal at 0 while the servo-off signal is 1. Generally, method (2) is used to operate the machine by rotating the motor with a handle feed mechanism.

- (2) V READY OFF alarm ignore signal IGNVRY

[Classification]

Output signal <Y1#6> (common to both the peripheral equipment and direct command interfaces)

[Function]

This signal is used to disable the detection of "Servo alarm (No. 0401): V ready off" for the controlled axis.

[Operation]

When the signal becomes 1, the control unit behaves as follows:

- Even when the servo amplifier preparation completion signal is off, "servo alarm (No. 401): V ready off" is not detected. The servo preparation completion signal SA becomes 0, however. (This signal can be held at 1 using the SAK parameter (bit 0 of parameter No. 004).

2.3.13

Peripheral Equipment Control Function Code and Related Information

- (1) Operation completion signals OPC1, OPC2, OPC3, and OPC4

[Classification]

Input signal <X0#4 to X0#7>

[Function]

The servo unit indicates information about the completion of each function code. The host executes its sequence according to this signal.

[Input condition]

See the timing chart of each function code for the corresponding input timing.

OPC1 indicates, to the host, that the servo unit has received a command. The servo unit issues an unclamp command signal (UCPC2 = 1) to request the host to unclamp the machine.

OPC2 indicates, to the host, that the servo unit has received an unclamp completed command signal (UCPS2 = 1). The servo unit starts axis operation.

OPC3 is output simultaneously with the clamp command signal (UCPC2 = 0) when axis operation is completed.

OPC4 indicates, to the host, that the servo unit has received the clamp completion signal (UCPS2 = 0) and finished executing all commands.

The timing at which the signal is input is set in parameter No. 166.

The clamp signal can be prevented from being used by resetting the NCLP parameter (bit 1 of parameter No. 003) to 0.

- (2) Function code

[Classification]

Output signal <Y2#4 to Y2#7>

[Function]

The host sets the peripheral equipment control function code.

[Output condition]

See the timing chart of each function code for the corresponding output timing. See Sections 3.3 and 3.4 for details.

- (3) Command data 1

[Classification]

Output signal <Y2#0 to Y2#3>

[Function]

The host sets command data 1 to specify the feed rate for peripheral equipment control.

[Output condition]

See the timing chart of each function code for the corresponding output timing. See Sections 3.3 and 3.4 for details.

(4) Command data 2

[Classification]

Output signal <Y3 to Y6>

[Function]

The host sets command data 2 to specify the amount of movement for peripheral equipment control.

[Output condition]

See the timing chart of each function code for the corresponding output timing. See Sections 3.3 and 3.4 for details.

(5) Response data

[Classification]

Input signal <X3 to X6>

[Function]

A) The servo unit outputs the current position number (point, turret, or magazine number) for point or ATC control. This response data is set up upon the completion of positioning. The servo unit continues to output the previous number until the new response data is set up.

B) Machine coordinates or workpiece coordinates can be output in real time according to the setting of parameter No. 020.

C) When the DSAL signal [Subsection 2.3.13.(7)] is 1, the servo unit outputs the number of alarms and the first alarm number.

[Input condition]

See the function code command list.

(6) Response data check signals DSP1 and DSP2

[Classification]

Input signal <X2#4 to X2#5>

[Function]

The servo unit indicates the contents of the response data.

[Input condition]

The servo unit specifies the response data using a combination of signals, as listed below.

Response data	DSP1	DSP2
Coordinate	1	1
Current position number	1	0

(7) Alarm output command signal DSAL

[Classification]

Output signal <Y0#3>

[Function]

The host specifies that alarm information be output as response data. When DSAL is 1, the following information is output as response data.

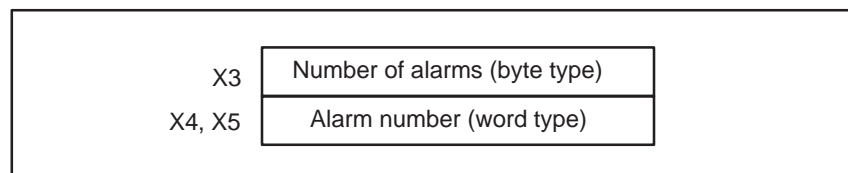
**[Operation]**

When the signal is 0, a turret, magazine, point number, or coordinates are output as response data. When the signal is 1, the number of alarms and the first alarm number are output as response data.

- (8) Alarm output state check signal DSALO

[Classification]

Input signal <X2#3>

[Function]

The servo unit indicates the contents of the response data.

[Input condition]

When the signal is 0, a turret, magazine, point number, or coordinates are being output as response data. When the signal is 1, the number of alarms and the first alarm number are being output as response data.

2.3.14

Direct Command Function Code and Related Information

- (1) Function code command strobe signal EBUF

[Classification]

Output signal <Y4#7>

[Function]

After setting the function code (Y5) and command data (Y6 to Y15), the host inverts the logical state of this signal to indicate to the servo unit that the function code is ready for transfer.

[Operation]

The servo unit exclusive-ORs EBUF with EBSY. If the result of exclusive ORing is 1, the servo unit behaves as follows:

- A) When the function code command is of a type to be buffered before execution.
1. If the function code command buffer of the servo unit is available, the servo unit receives the function code command at the function code command buffer.
 2. If the function code command buffer of the servo unit is unavailable, the servo unit waits until it becomes available, that is, rejects reception of the current function code command.
- B) If the function code command is of a type to be executed immediately without being buffered
1. The servo unit receives the function code command at its execution buffer immediately and starts processing according to the function code command.

- (2) Function code command read completion signal EBSY

[Classification]

Input signal <X4#7>

[Function]

The servo unit indicates that it has accepted a function code command. Because the result of exclusive-ORing EBUF and EBSY becomes 0, it becomes possible to issue another function code.

[Input condition]

The state of the signal is inverted when a function code command is received by the servo unit.

- (3) Function code

[Classification]

Output signal <Y5>

[Function]

The host specifies the function code command to be executed.

[Operation]

The servo unit behaves as directed by the function code command when receiving it.

See "Direct command function details" for details.

- (4) Command data
[Classification]
Output signal <Y6 to Y15>
[Function]
The host provides data for a function code command.
[Operation]
The servo unit behaves as directed by the function code command when receiving it.
See "Direct command function details" for details.
- (5) Response data
[Classification]
Input signal <X7 to X15>
[Function]
A) The servo unit returns the result of function code command execution.
B) The servo unit returns the data requested by the function code.
C) The servo unit outputs continuous-output data, such as the current position, requested by the continuous read command.
[Input condition]
A) The servo unit returns the result of function code command execution. It is possible to defer the return of the result of each function code command and return their results at the same time, if they are of a type that can be buffered.
B) The servo unit outputs data, such as alarm information, requested by the function code.
C) If the host is to receive data, such as the current position, that is being monitored continuously, the servo unit continues to output the requested data in response to a single request.
After setting the above data or result, the servo unit inverts the state of EOSTB. They can be read when the result of exclusive-ORing EOREND with EOSTB is 1. EOPC indicates that the current data is of continuous output type. When EOPC is 0, it indicates data covered in A) or B. When it is 1, it indicates data covered in C).
- (6) Continuously output data signal EOPC
[Classification]
Input signal <X4#2>
[Function]
The servo unit indicates that continuously output data requested using a function code command is being output as response data.
[Input condition]
The signal is 1 when:
1. Continuously output data requested by a function code command is being output as response data.
The signal is 0 when:
1. Data other than continuously output data requested by a function code command is being output as response data.
- (7) Response data readable signal EOSTB
[Classification]
Input signal <X4#6>
[Function]
The servo unit indicates that data requested using a function code command has been output as response data and is now readable.
[Input condition]
The state of the signal is inverted when:
1. The response data becomes readable.

(8) Response data read completion signal EOREND

[Classification]

Output signal <Y4#6>

[Function]

The host notifies the servo unit that it has read response data.

[Operation]

When the state of the signal is inverted, the servo unit behaves as follows:

1. The result of function code command execution is output as response data.
2. If a function code command is a data output command, the command is executed, and the result is output as response data.

CAUTION

If the result of exclusive-ORing EOSTB with EOREND is 1, it becomes impossible to output further command data. Before inverting the state of EOREND, apply appropriate countermeasures.

(9) Command continuation notification signal ECNT

[Classification]

Output signal <Y4#0>

[Function]

When the host has too much command data to be sent at one time, it sets the ECNT signal to 1 to inform the slave that remaining data exists.

[Operation]

When the ECNT signal becomes 1, the servo unit behaves as follows:

1. After receiving command data from the buffer, the servo unit inverts the state of the EBSY signal so that it matches the state of the EBUF, thereby prompting the transfer of the next data.

The signal is reset to 0 at the last data of a series of commands.

(10) PMM data signal USR1

[Classification]

Input signal <X4#3>

[Function]

Direct commands transfer data using the same area as the power motion manager function. If USR1 is 0, it is necessary to perform special processing to read the data, because it is a response from the ladder program of the host. If USR1 is 1, the ladder program ignores response data, because it is for the power motion manager.

[Input condition]

The signal is 1 when:

1. The response data is power motion data.

The signal is 0 when:

1. The response data is data from a ladder program.

(11) Response data continuation notification signal ECONT

[Classification]

Input signal <X4#0>

[Function]

If there is too much response data to be sent at one time, the ECONT signal is set to 1. In this case, after reading the current data, the host waits for the next data. The host must continue to read data for as long as the ECONT signal is 1.

[Input condition]

The signal is 0 when:

1. Remaining response data exists.

The signal is 1 when:

1. All response data has been read.

(12) Function code command completion notification signal ECF

[Classification]

Input signal <X4#5>

[Function]

If function code command execution completion notification mode is entered with NMOD set to 1, the servo unit sets ECF to 1 to indicate that positioning directed by this command has been completed, and waits for the next command to be executed until the host responds. The host issues the SET FIN command to cause processing to move to the next command.

[Input condition]

The signal becomes 1 when:

1. The system enters function code command execution completion notification mode with NMOD set to 1, and positioning directed by the function code is completed.

The signal becomes 0 when:

1. The SET FIN command is executed.

(13) Alarm signal DAL

[Classification]

Input signal <X4#1>

[Function]

If an alarm condition occurs in the servo unit, the servo unit sets the DAL signal to 1. The host issues a READ ALARM STATUS command to read details of the alarm condition, as required.

[Input condition]

The signal becomes 1:

1. When an alarm condition occurs in the slave.

The signal is 0:

1. When there is no alarm condition in the slave.

(14) Wait signal WAT

[Classification]

Input signal <X1#0>

[Function]

The servo unit indicates, to the host, that it is in the wait state. After performing the necessary processing, the host returns a wait completion signal (WFN) to cause the servo unit to continue operating. This method is used by the servo unit to request the host to perform processing, when the servo unit is running continuously in memory operation mode.

[Input condition]

The signal becomes 1 when:

1. The servo unit executes a wait command during memory operation.

The signal becomes 0 when:

1. The host sets the wait completion signal WFN to 1.

(15) Wait completion signal WFN

[Classification]

Output signal <Y1#4>

[Function]

If the servo unit issues wait signal WAT to cause it to enter the wait state, the host releases the servo unit from the wait state. Upon receiving the wait completion signal, the servo unit executes the next command.

[Operation]

When the servo unit is in the wait state, it sets the wait signal WFN to 1. If the WFN signal is set to 1 under this condition, the servo unit and host behave as follows:

1. The servo unit resets the wait signal WAT to 0. Upon detecting that the WAT becomes 0, the host resets the WFN to 0. The servo unit exits from the wait state and executes the next command.

(16) Memory registration signal INPF

[Classification]

Output signal <Y3#7>

[Function]

The host can store function code commands into the memory of the servo unit and control memory operation according to the data in the memory. If buffering type function code, such as a position command, is issued with INPF set to 1, it is registered into memory instead of being executed. Up to 32 blocks can be registered. Once a series of registration operations has been completed, the INPF is reset to 0. This command is erased when the power is switched off. It is necessary to register it in memory before memory operation is used. If the INPF is set to 1 when function code is already registered in memory, the function code is cleared from memory, allowing new function code to be registered.

[Operation]

If buffering type function code is issued with INPF set to 1, it is stored into memory instead of being executed.

(17)Memory registration in-progress signal INPFO

[Classification]

Input signal <X3#7>

[Function]

The servo unit indicates, to the host, that it is in memory registration mode. When the INPFO signal is 1, a buffering type function code command, such as a positioning command, is stored into memory instead of being executed.

[Input condition]

The signal becomes 1 when:

1. The host sets the INPF signal to 1 to specify memory registration mode, and the servo unit enters memory registration mode.

The signal becomes 0 when:

1. The host resets the INPF signal to 0 to release memory registration mode, and the servo unit exits from memory registration mode.

(18)Interface switch signal DRC

[Classification]

Output signal <Y1#5>

[Function]

The host informs the servo unit of the interface type (peripheral equipment control interface or direct command interface) to be used.

[Operation]

When the DRC signal is 0, the slave runs using the peripheral equipment control interface. When it is 1, the slave runs using the direct command interface. The servo unit also sends the interface status notification signal DRCO ((19) of Section 2.3.14) to the host. After detecting the DRCO signal, the host issues commands.

After changing the DRC signal, the host should not issue a command within one scan after the DRCO signal changes. Once the state of the DRC signal is inverted, do not invert it again before the state of the DRCO signal changes accordingly, as data communication with the servo unit is hindered. Before inverting the state of the DRC signal again, wait for at least one scan after the state of the DRCO signal changes.

CAUTION

Usually, the DRC signal should not be switched while the power is switched on. If necessary, it should be switched during a reset state, that is, while neither automatic nor JOG operation is in progress. Moreover, it should not be switched when the motor is not in the in-position state.

(19)Interface status notification signal DRCO

[Classification]

Input signal <X1#1>

[Function]

The servo unit informs the host of the current interface mode (peripheral equipment control or direct command interface). After detecting the DRCO signal, the host issues commands.

[Input condition]

The signal is 1 when:

1. The slave is in direct command interface mode.

The signal is 0 when:

1. The slave is in peripheral equipment control interface mode.

2.3.15 Direct Input Signals

NOTE

The following signals are not host-to-servo unit I/O link interface signals.

- (1) Emergency stop signal *ESP

[Classification]

Servo unit direct input signal

[Function]

The host stops the servo unit immediately.

[Operation]

When the signal becomes 0, the servo unit behaves as follows:

1. Axis movement is decelerated to a stop immediately.
2. A reset is performed after a stop.
3. The servo system cannot operate for as long as the emergency stop signal is 0. So, the servo preparation completion signal SA is held at 0. If the machine is shifted while the SA is 0, the shift is reflected in the current coordinates in the servo unit; the current position will not be lost (follow-up).
4. Neither jog feed nor a function code command can be issued while the emergency stop signal is 0.

- (2) Overtravel signals *-OT and *+OT

[Classification]

Servo unit direct input signal

[Function]

The host indicates that the controlled axis has reached the stroke limit described below.

*-OT: The stroke limit in the negative direction has been reached.

*+OT: The stroke limit in the positive direction has been reached.

[Operation]

When the signal becomes 0, the servo unit behaves as follows:

1. The controlled axis is stopped immediately by zero-speed-based deceleration, and an OT alarm for the input direction is output.
2. The direction in which the signal becomes 0 is memorized. Even after the signal is returned to 1, the controlled axis is prevented from operating in that direction until the OT alarm is reset.

- (3) High-speed interlock signal *RILK

[Classification]

Servo unit direct input signal

[Function]

The host stops jog feed and function code command-specified feed.

[Operation]

While the signal is 0, the servo unit resets the jog feed and function code command-specified feed to 0 to stop controlled axis feed. Axis movement is decelerated to a stop.

A move command remains valid even when the signal is 0. Movement can be resumed immediately when the signal is set to 1 again. This does not affect non-move commands.

3

PERIPHERAL EQUIPMENT CONTROL



3.1 COMMAND FORMAT FOR PERIPHERAL EQUIPMENT CONTROL

The servo unit receives a command, issued in the specified format, from the host, then executes a sequence of operations for performing peripheral equipment control. When a command for reading the current position is specified, the servo unit returns the result of command execution to the host. The command and result are exchanged, in an interface area, in the formats shown below.

- General format of instruction commands (host → servo unit)

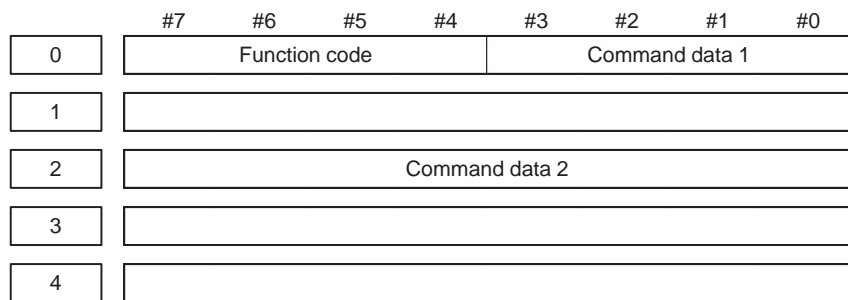

- General format of response commands (servo unit → host)

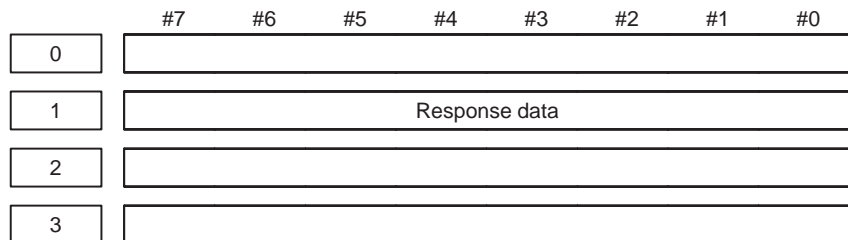

- Data types

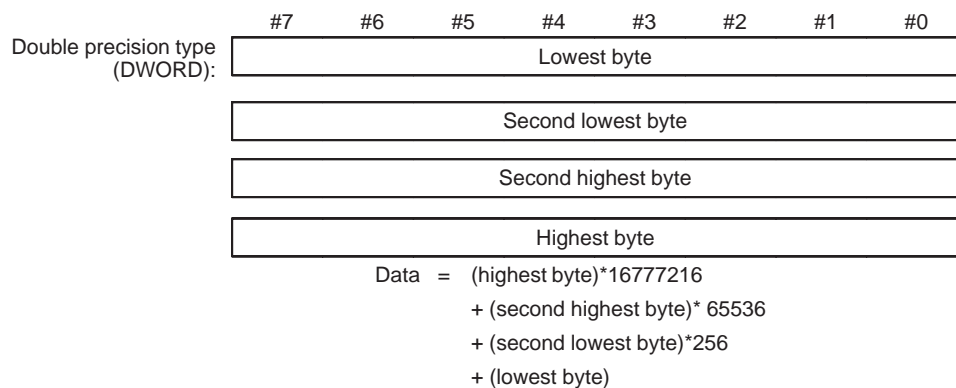
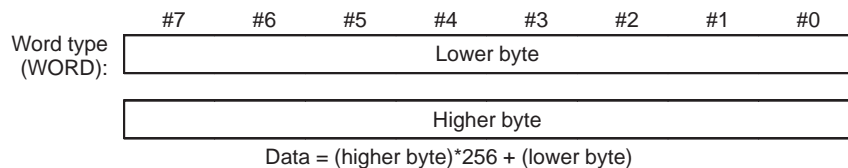
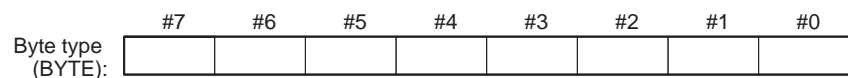

3.2 PERIPHERAL EQUIPMENT CONTROL PROCEDURE

3.2.1 Specifying Operation Using a Function Code

In peripheral equipment control, the host sets a function code, command data 1, and command data 2, then turns the start signal (ST) in the interface area on then off to start the instruction command.

The servo unit returns a completion signal (OPC1, OPC2, OPC3, OPC4) according to the status of command execution; the host performs the corresponding processing.

OPC1: This signal notifies the host that a function code has been received.
At the same time, the unclamp command is output.

OPC2: This signal notifies the host that the unclamp state output signal has been received.

OPC3: This signal notifies the host that a movement has been completed.
At the same time, the clamp command is output.

OPC4: This signal notifies the host that the clamp state output signal has been received, and that a function code has been executed.
Response data, if any, is set at the same time.

Until completion signal 4 is received, the next instruction command must not be set.

CAUTION

When the clamp/unclamp function is not used, OPC2 and OPC3 are not output from the servo unit.

3.2.2 Receiving Response Data

From the response data, the host can read the current position of the axis controlled by a servo amplifier as well as any alarm information.

To read alarm information, the host sets the alarm output command signal (DSAL) to 1. When the alarm output state check signal (DSALO) is 1, the number of alarms and alarm numbers are returned as response data.

When the alarm output command signal (DSAL) is set to 0, position information is set as response data. Position data can be selected using parameter No. 20 (PHOUT). The type of data can be checked using a response data check signal (DSP1, DSP2).

3.3 FUNCTION CODES

3.3.1 Function Codes

Function code	Command data 1 4 bits	Command data 2 4 bytes	Mode	Start signal	Remarks
0 : Jog operation			JOG	+X/-X	
2 : ATC operation	1 : Automatic operation (shortcut rotation) 2 : Automatic operation (positive direction) 3 : Automatic operation (negative direction)	Turret/magazine number	AUTO	ST	Set an amount of travel per ATC rotation and the number of turrets/ magazines in the parameters. (Caution 2, Caution 9)
	4 : 1-pitch rotation 5 : Continuous indexing (Caution 1)		JOG	+X/-X	
3 : Point positioning	Feedrate code 1 to 7 15: Rapid traverse	Point number 1 to 12	AUTO	ST	(Caution 3) (Caution 4) (Caution 5)
4 : Reference position return	Reference position number 1 : First reference position 2 : Second reference position 3 : Third reference position		JOG	ST	(Caution 4)
	15: Reference position setting (Caution 6)			+X/-X	
	15: Reference position external setting (Caution 8)			ST	
5 : Positioning (absolute specification)	Feedrate code 1 to 7 15: Rapid traverse	Workpiece coordinates	AUTO	ST	(Caution 4)
6 : Positioning (incremental specification)	Feedrate code 1 to 7 15: Rapid traverse	Travel distance	AUTO	ST	(Caution 4)
10: Coordinate system setting	1 : Coordinate system setting 2 : Magazine number setting 3 : Point number setting	Coordinates Magazine number Point number	AUTO	ST	The coordinates corre- sponding to a number represent the current position.
14: Point data external setting	Point number 1 to 12	Point data	JOG	ST	Data is entered into the parameter correspond- ing to a point number.
15: Data setting by teaching		Point number 1 to 12	JOG	ST	A coordinate is entered into the parameter cor- responding to a point number.

CAUTION

- 1 If the remaining distance to the next point is shorter than the required deceleration distance for stopping at that point when the feed axis and direction selection switch (+X, -X) is released, movement is made to the point immediately after the next point.
- 2 Set bit 1 (ROTX) of parameter No. 000 (for rotation axis setting) to 1, and set bit 7 (ROAX) of parameter No. 000 to 1 (for rollover).
- 3 As the position corresponding to each point number, workpiece coordinates are set in parameter Nos. 154 to 165.
- 4 The feedrates of feedrate codes 1 to 7 are set in parameter Nos. 044 to 050, and a rapid traverse rate is set in parameter No. 040.
- 5 In rollover setting, shortcut control is possible. In rollover setting, set a value within +1 rotation for the absolute positioning command.
- 6 When a reference position is set after the power is turned on, magazine/turret number 1 is output. Before reference position setting, perform movement by jog operation for a minimum given distance at a minimum given feedrate (distance and feedrate for accumulating a servo position deviation of 128 pulses or more). Then, set function code 4, and command data 1 = 15, and turn on +X/-X to perform reference position return. If bit 1 (SZRN) of parameter No. 011 is set, the reference position can be shifted one grid each time +X/-X is turned on.
- 7 Normal jog feed operation can be used only when function code 0, 1, 10, or 15 is specified.
- 8 When an absolute pulse coder is used, the current position can be used as a reference position. After positioning to a reference position, set function code 4, command data 1 = 15, jog mode, and emergency stop release state, then turn on the ST signal.
- 9 In ATC automatic operation mode, the rapid traverse rate (parameter No. 040) is used unconditionally. In jog operation mode, the rapid traverse rate (parameter No. 040) is used when the RT signal is turned on. The jog feedrate (parameter No. 041) is used when the RT signal is turned off.
- 10 Never change the current mode during operation. The mode can be changed only after operation has been stopped.

3.4 DETAILS OF FUNCTION CODES

3.4.1 ATC/Turret Control

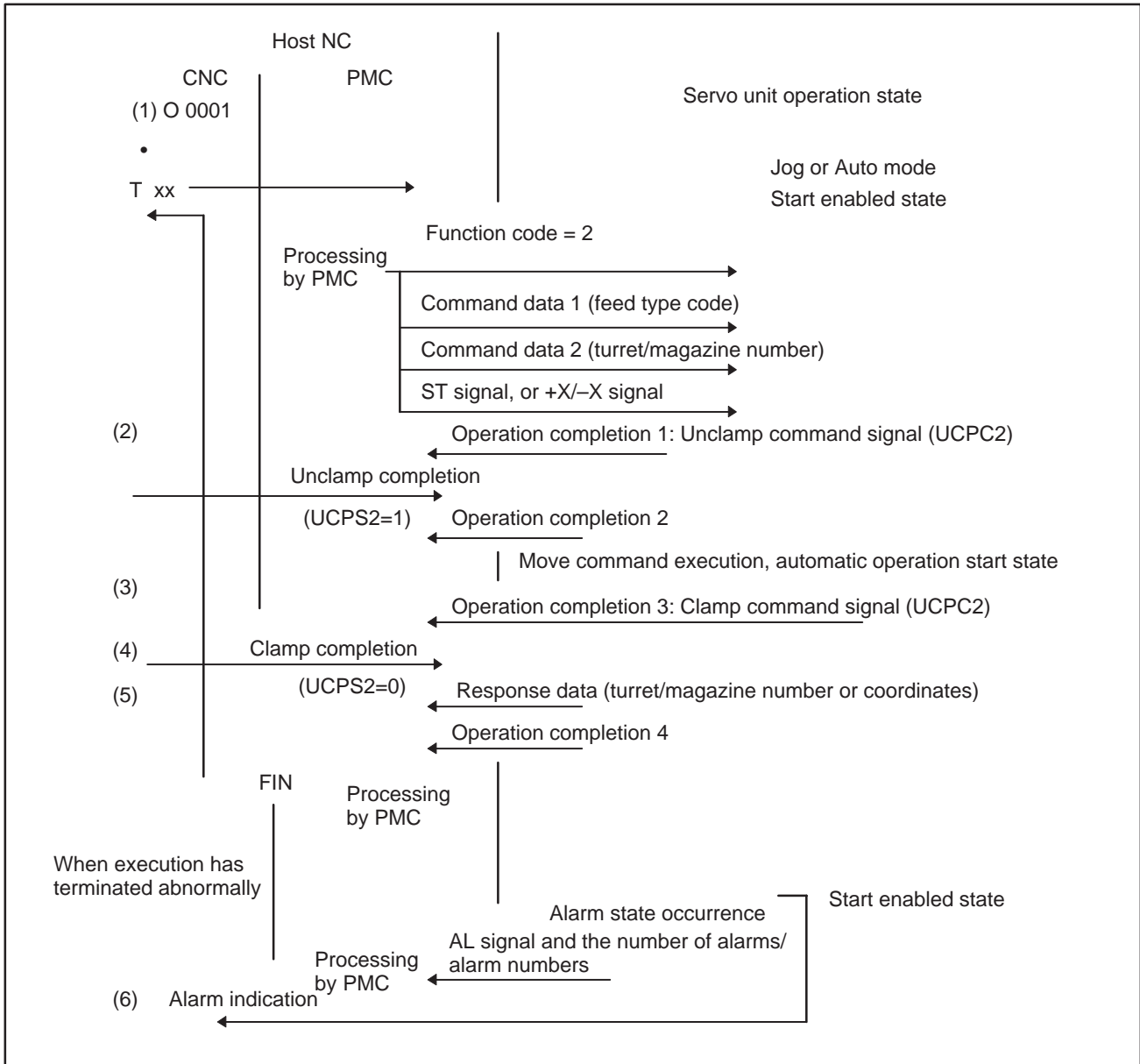

- (1) When the host NC program executes a T code command, the PMC on the host NC sets the function code, command data 1, and command data 2, then sends the ST signal or +X/-X signal to the servo unit. Upon receipt of the data, the servo unit returns the operation completion 1 signal to the NC, and also outputs the unclamp command signal.
- (2) When unclamp completion notification is sent from the host NC, the servo unit returns the operation completion 2 signal to the host NC, then starts movement to the position corresponding to a specified turret/magazine number.
- (3) Upon completion of the movement, the servo unit returns the operation completion 3 signal to the NC, and also outputs the clamp command signal.
- (4) When clamp completion notification is sent from the host NC, the servo unit returns response data (turret/magazine number or coordinates) and the operation completion 4 signal, and is placed in the start enabled state.
- (5) Upon receipt of the operation completion 4 signal, the PMC on the host NC returns the FIN signal.
- (6) If an alarm is issued while the servo unit is executing an instruction, the AL signal is output. So, the PMC on the host NC is to perform processing such as alarm indication. In this case, the number of alarms and alarm numbers can be included in the response data by setting the DSAL signal [Subsection 2.3.13.(7)] to 1.

Supplementary information

- 1) The unclamp/clamp command signal and state signal are used for communication with the host.
- 2) Whether the unclamp/clamp state signal is to be checked is specified by setting bit 2 (IGCP) of parameter No. 003. When IGCP is set such that no check is to be made, the operation completion 2 signal and operation completion 3 signal are not output.
- 3) Use parameter No. 167 to set the period between the servo unit being turned on and the output of the unclamp command signal. Use parameter No. 168 to set the period between the clamp command signal being output and the servo unit being turned off.
- 4) The ST signal can be accepted in the start enabled state only.
- 5) The start enabled state is that state in which the STL signal is off.

3.4.2 Point Positioning Control

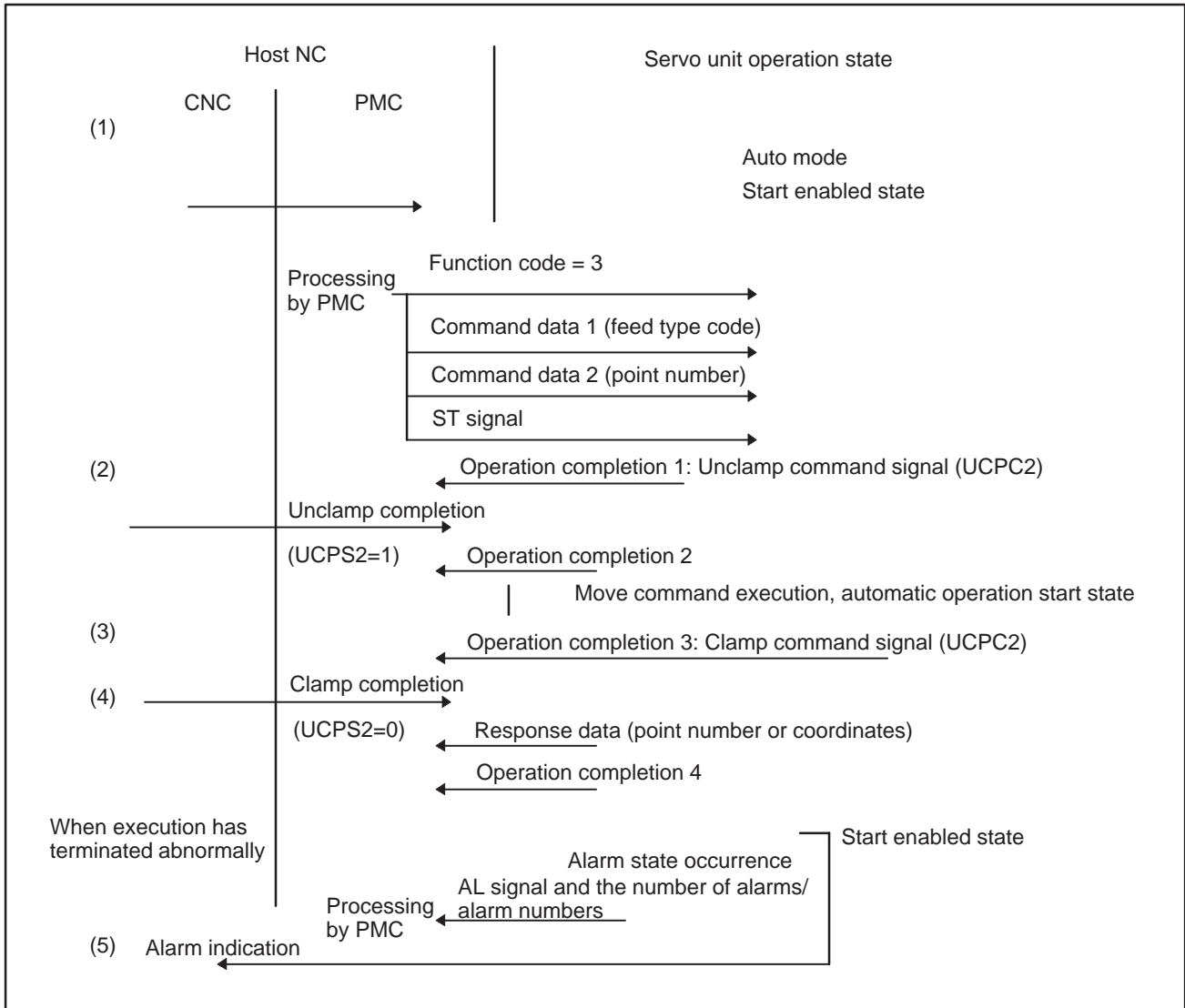

- (1) The PMC on the host NC sets the function code, command data 1, and command data 2, then sends the ST signal to the servo unit. Upon receipt of the data, the servo unit returns the operation completion 1 signal to the host NC, and also outputs the unclamp command signal to the host NC.
- (2) When unclamp completion notification is sent from the host NC, the servo unit returns the operation completion 2 signal to the NC, and starts movement to the position corresponding to a specified point number.
- (3) Upon completion of the movement, the servo unit returns the operation completion 3 signal to the host NC, and also outputs the clamp command signal to the host NC.
- (4) When clamp completion notification is sent from the host NC, the servo unit returns response data (point number or coordinates) and the operation completion 4 signal, and is placed in the start enabled state.
- (5) If an alarm is issued while the servo unit is executing an instruction, the AL signal is output. So, the PMC on the host NC is to perform processing such as alarm indication. In this case, the number of alarms and alarm numbers can be included in the response data by setting the DSAL signal [Subsection 2.3.13.(7)] to 1.

Supplementary information

- 1) The unclamp/clamp command signal and state signal are used for communication with the host.
- 2) Whether the unclamp/clamp state signal is to be checked is specified by setting bit 2 (IGCP) of parameter No. 003. When IGCP is set such that no check is performed, the operation completion 2 signal and operation completion 3 signal are not output.
- 3) Use parameter No. 167 to set the period between the servo unit being turned on and the unclamp command signal being output. Use parameter No. 168 to set the period between the clamp command signal being output and the servo unit being turned off.
- 4) The ST signal can be accepted in the start enabled state only.
- 5) The start enabled state is that state in which the STL signal is off.

3.4.3 Reference Position Return

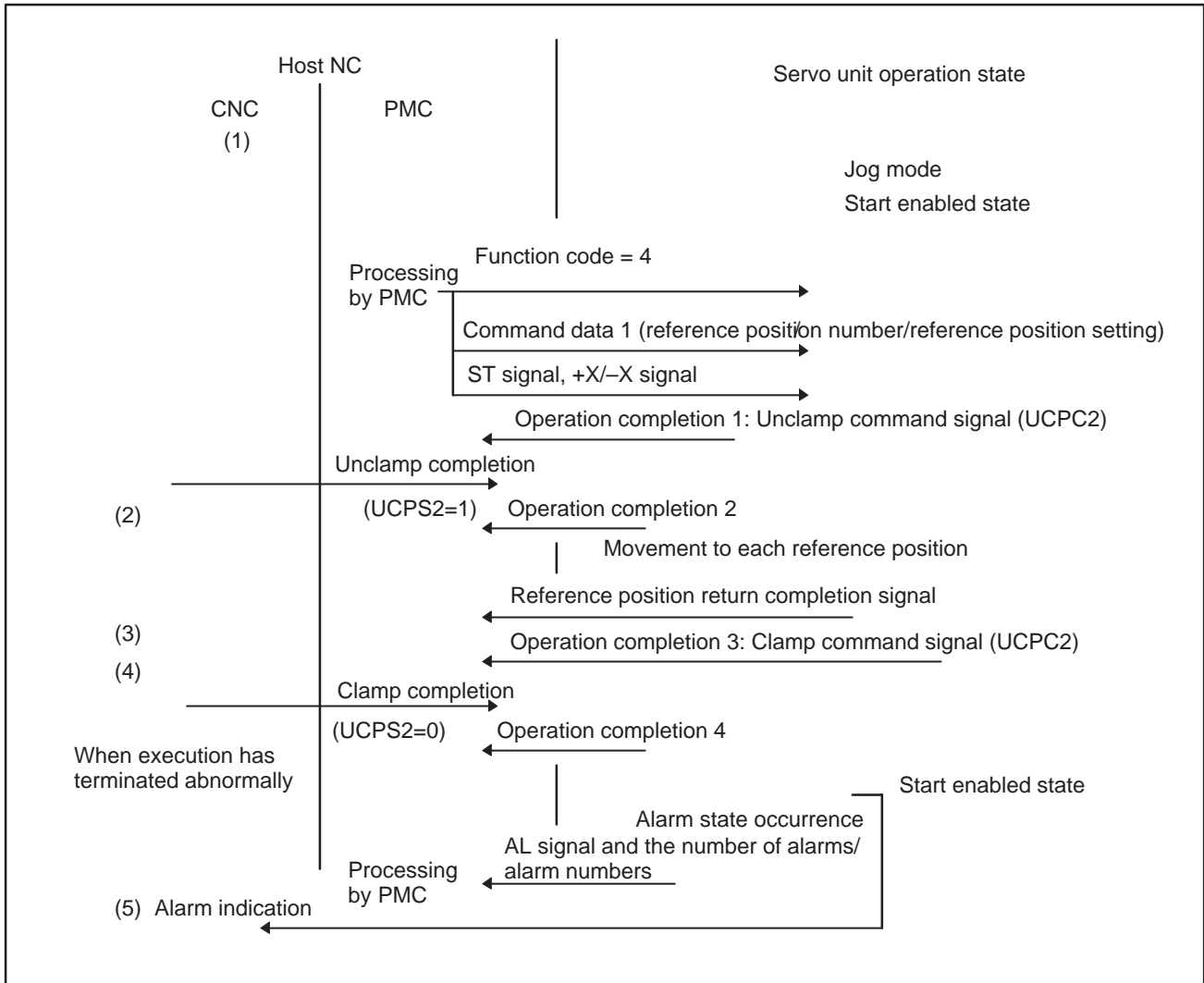

- (1) The PMC on the host NC sets the function code and command data 1, then sends the ST signal or +X/-X signal to the servo unit. Upon receipt of the data, the servo unit returns the operation completion 1 signal to the host NC, and also outputs the unclamp command signal.
- (2) When unclamp completion notification is sent from the host NC, the servo unit returns the operation completion 2 signal to the NC, and starts movement to a specified reference position.
- (3) Upon completion of the movement, the servo unit returns the reference position return completion signal and operation completion 3 signal to the host NC, and also outputs the clamp command signal.
- (4) When clamp completion notification is sent from the host NC, the servo unit returns the operation completion 4 signal to the NC, enters the start enabled state, then ends the cycle.
- (5) If an alarm is issued while the servo unit is executing a reference position return operation, the AL signal is output. So, the PMC on the host NC is to perform processing such as alarm indication. In this case, the number of alarms and alarm numbers can be included in the response data by setting the DSAL signal [Subsection 2.3.13.(7)] to 1.

Supplementary information

- 1) The unclamp/clamp command signal and state signal are used for communication with the host.
- 2) Whether the unclamp/clamp state signal is to be checked specified by setting bit 2 (IGCP) of parameter No. 003. When IGCP is set such that no check is performed, the operation completion 2 signal and operation completion 3 signal are not output.
- 3) Use parameter No. 167 to set the period between the servo unit being turned on and the unclamp command signal being output. Use parameter No. 168 to set the period between the clamp command signal being output and the servo unit being turned off.
- 4) The ST signal can be accepted only in the start enabled state.
- 5) The start enabled state is that state in which the STL signal is off.

3.4.4 Reference Position Setting (when the Reference Position External Setting Function is Used)

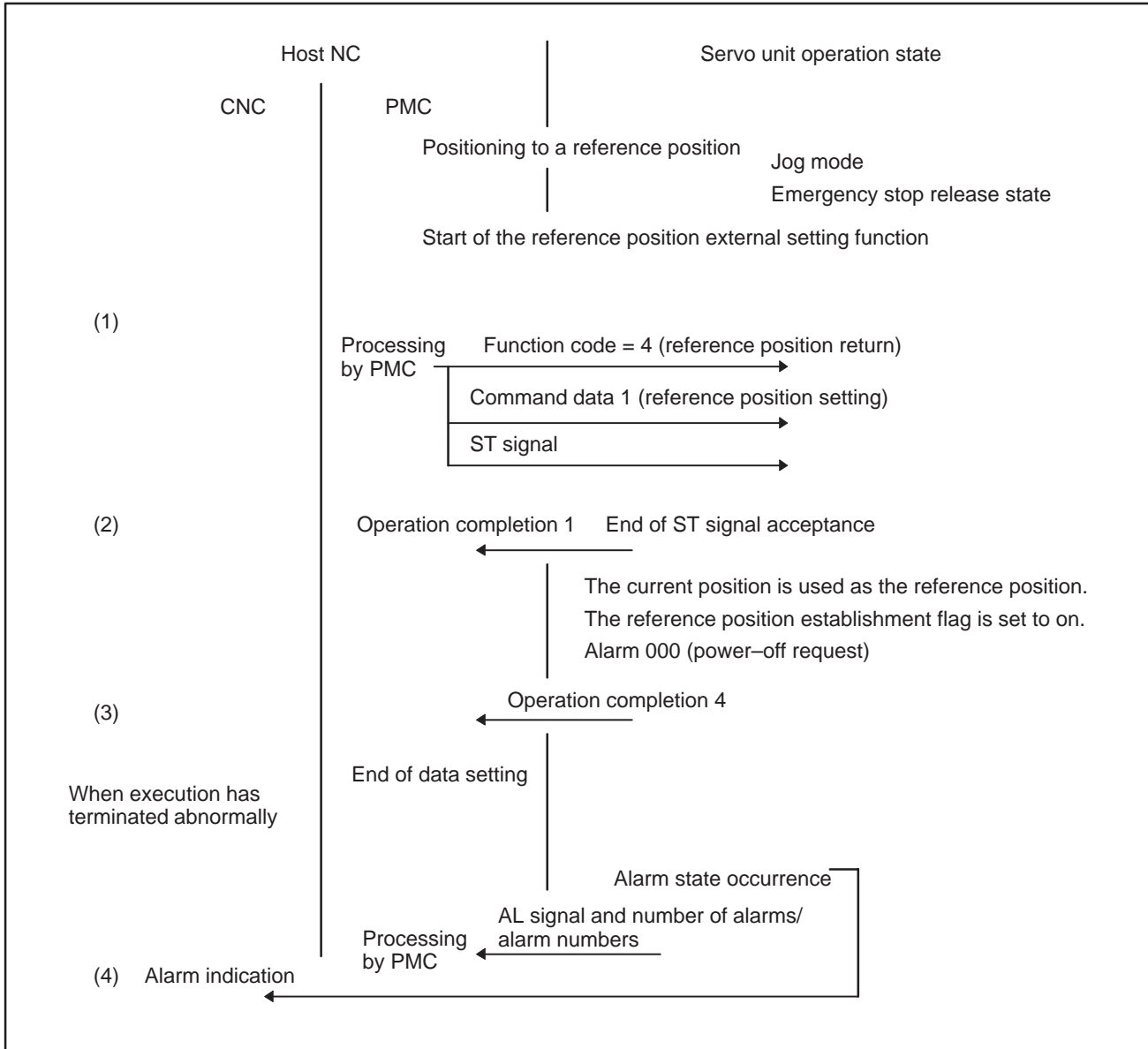

- (1) When the reference position external setting function is used, the PMC on the host NC sets the function code and command data 1, then sends the ST signal to the servo unit after positioning to the reference position.
- (2) Upon receipt of the data, the servo unit returns the operation completion 1 signal to the host NC.
- (3) The servo unit uses the current position as the reference position, sets the reference position establishment flag (bit 0 (ABSX) of parameter No. 011), outputs alarm 000 (power-off request), returns the operation completion 4 signal, then terminates.
- (4) If an alarm is issued while the servo unit is executing reference position setting, the AL signal is output. So, the PMC on the host NC is to perform processing such as alarm indication. In this case, the number of alarms and alarm numbers can be included in the response data by setting the DSAL signal [Subsection 2.3.13.(7)] to 1.

Supplementary information

- 1) This function is enabled only when an absolute pulse coder is used.
- 2) The start enabled state is that state where the STL signal is off.

3.4.5 Positioning Control (Absolute/Incremental Specification)

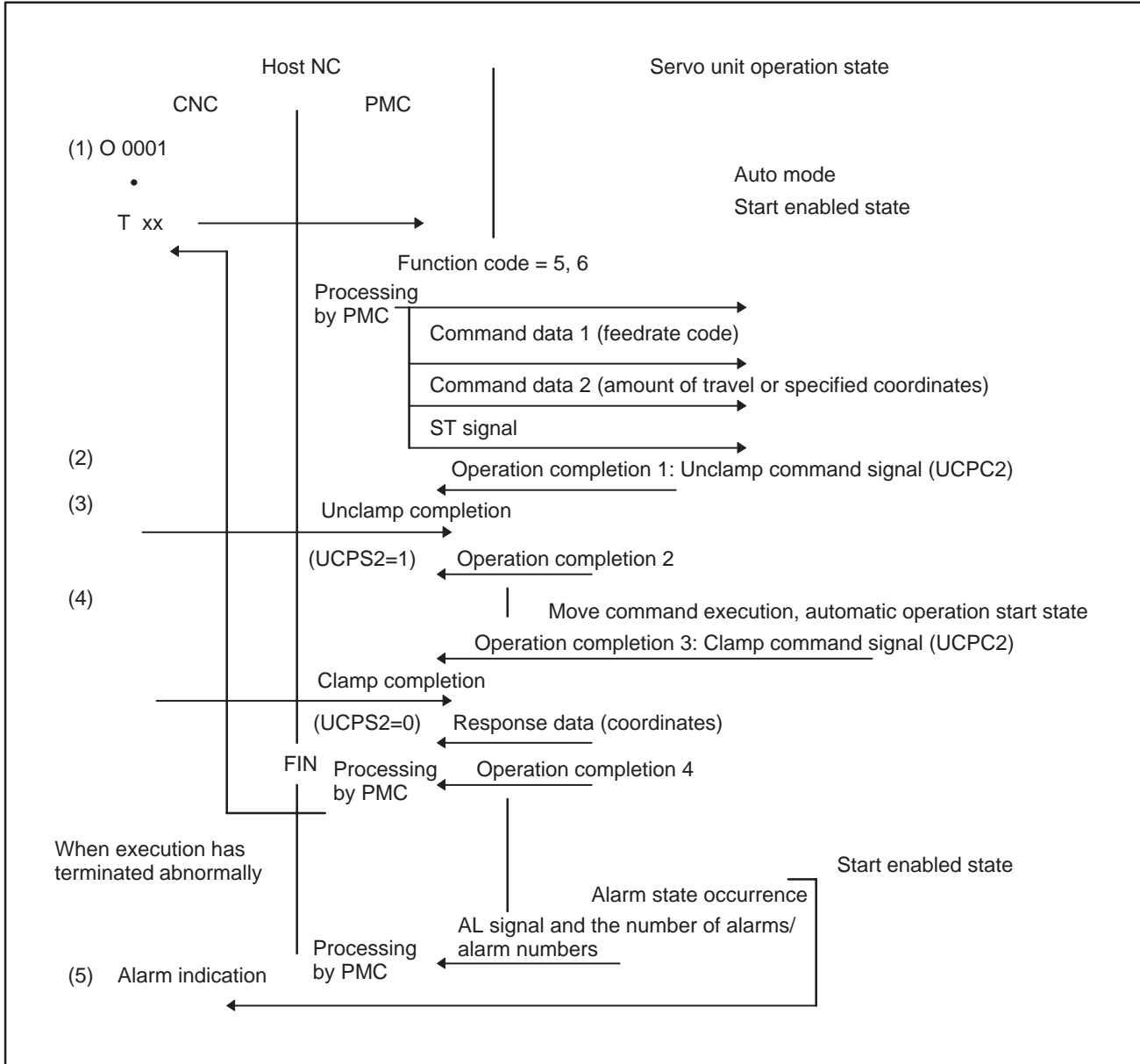

- (1) The PMC on the host NC sets a function code, command data 1, and command data 2, then sends the ST signal to the servo unit. Upon receipt of the data, the servo unit returns the operation completion 1 signal to the host NC, and also outputs the unclamp command signal to the host NC.
- (2) When unclamp completion notification is sent from the host NC, the servo unit returns the operation completion 2 signal to the NC, then starts movement.
- (3) Upon completion of the movement, the servo unit returns the operation completion 3 signal to the host NC, and also outputs the clamp command signal to the host NC.
- (4) When clamp completion notification is sent from the host NC, the servo unit returns response data (coordinates) and the operation completion 4 signal, and is placed in the start enabled state.
- (5) If an alarm is issued while the servo unit is executing an instruction, the AL signal is output. So, the PMC on the host NC is to perform processing such as alarm indication. In this case, the number of alarms and alarm numbers can be included in the response data by setting the DSAL signal [Subsection 2.3.13.(7)] to 1.

Supplementary information

- 1) The unclamp/clamp command signal and state signal are used for communication with the host.
- 2) Whether the unclamp/clamp state signal is to be checked is specified by setting bit 2 (IGCP) of parameter No. 003. When IGCP is set such that no check is performed, the operation completion 2 signal and operation completion 3 signal are not output.
- 3) Use parameter No. 167 to set the period between the servo unit being turned on and the unclamp command signal being output. Use parameter No. 168 to set the period between the clamp command signal being output and the servo unit being turned off.
- 4) The ST signal can be accepted in the start enabled state only.
- 5) The start enabled state is that state in which the STL signal is off.

3.4.6 Coordinate System Setting

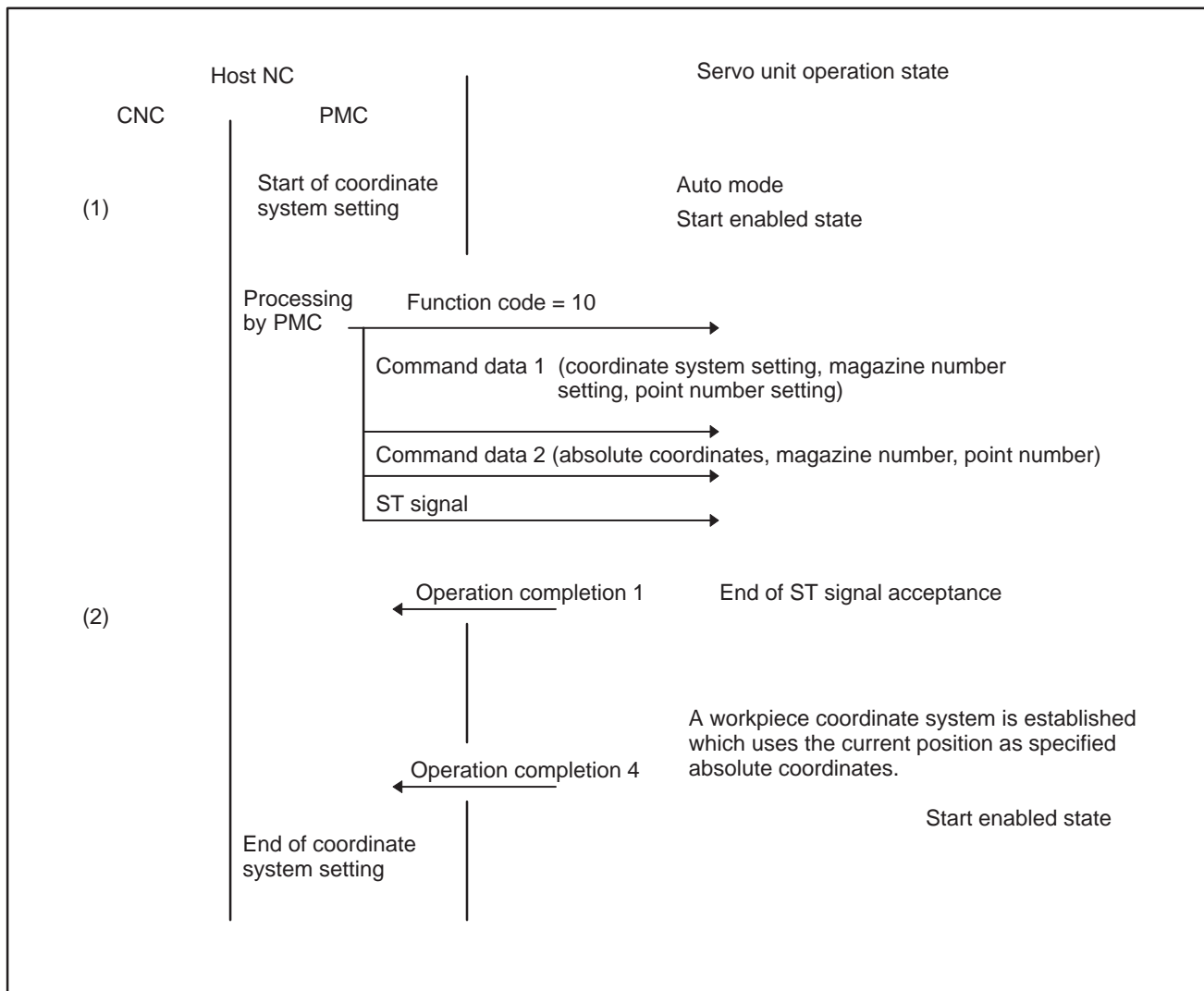

- (1) In coordinate system setting, the PMC on the host NC sets the function code, command data 1, and command data 2, then sends the ST signal to the servo unit. Upon receipt of the data, the servo unit returns the operation completion 1 signal to the NC.
- (2) Upon completion of coordinate system setting, the servo unit returns the operation completion 4 signal, and is placed in the start enabled state.

Supplementary information

- 1) The start enabled state is that state in which the STL signal is off.

3.4.7 Teaching-based Data Setting Control

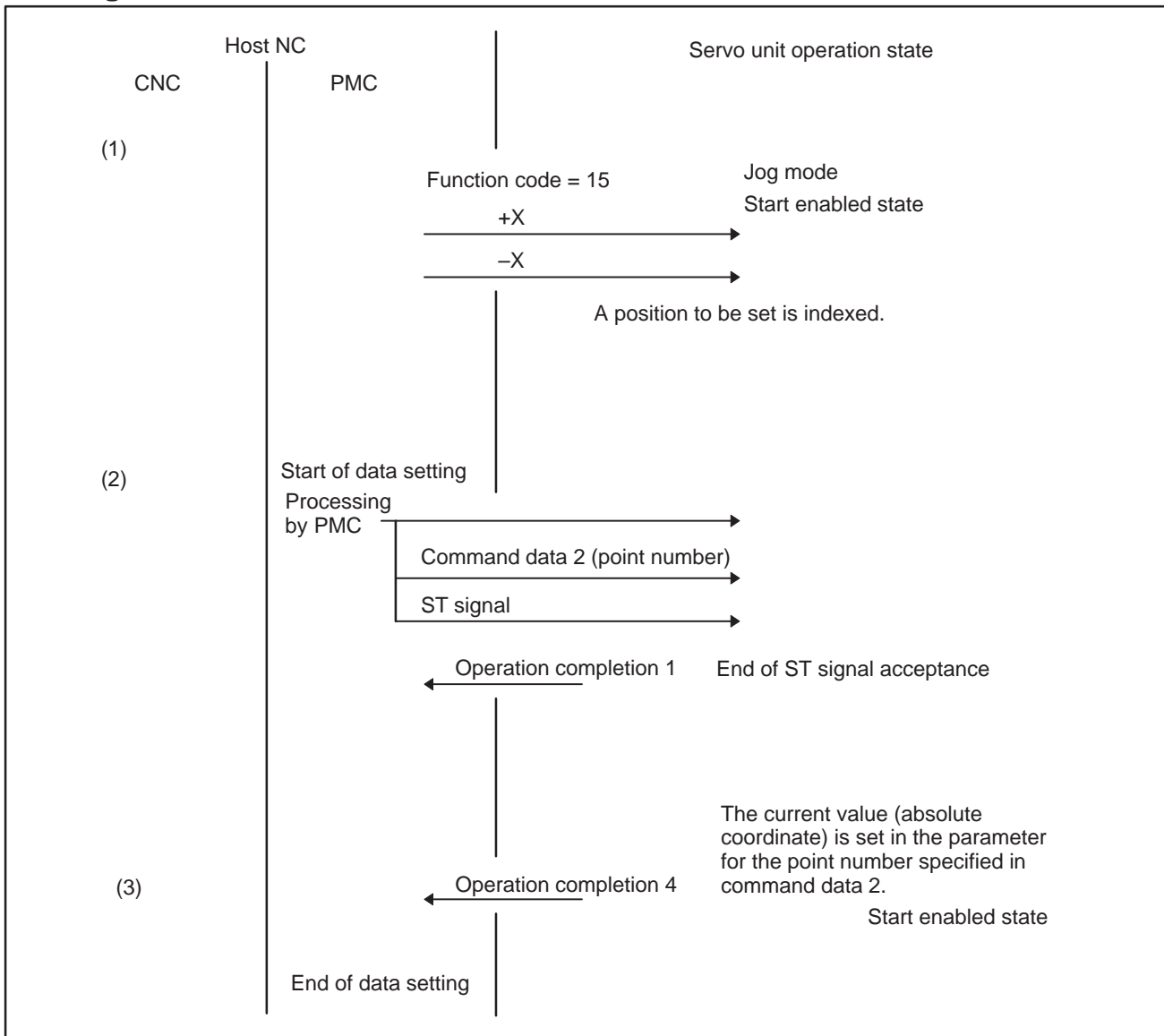

- (1) After function code setting, the host indexes a position according to the +X/-X signal.
- (2) In data setting, the PMC on the host NC sets the function code and command data 2, then sends the ST signal to the servo unit. Upon receipt of command data 2, the servo unit returns the operation completion 1 signal to the NC.
- (3) Upon the completion of setting the current value in a parameter, the servo unit returns the operation completion 4 signal, and is placed in the start enabled state.

Supplementary information

- 1) The coordinate for a point number is set in the parameter area.
- 2) Perform teaching-based data setting while no movement is being performed along the axes.
- 3) The start enabled state is that state in which the STL signal is off.

3.4.8 Control of the Point Data External Setting Function

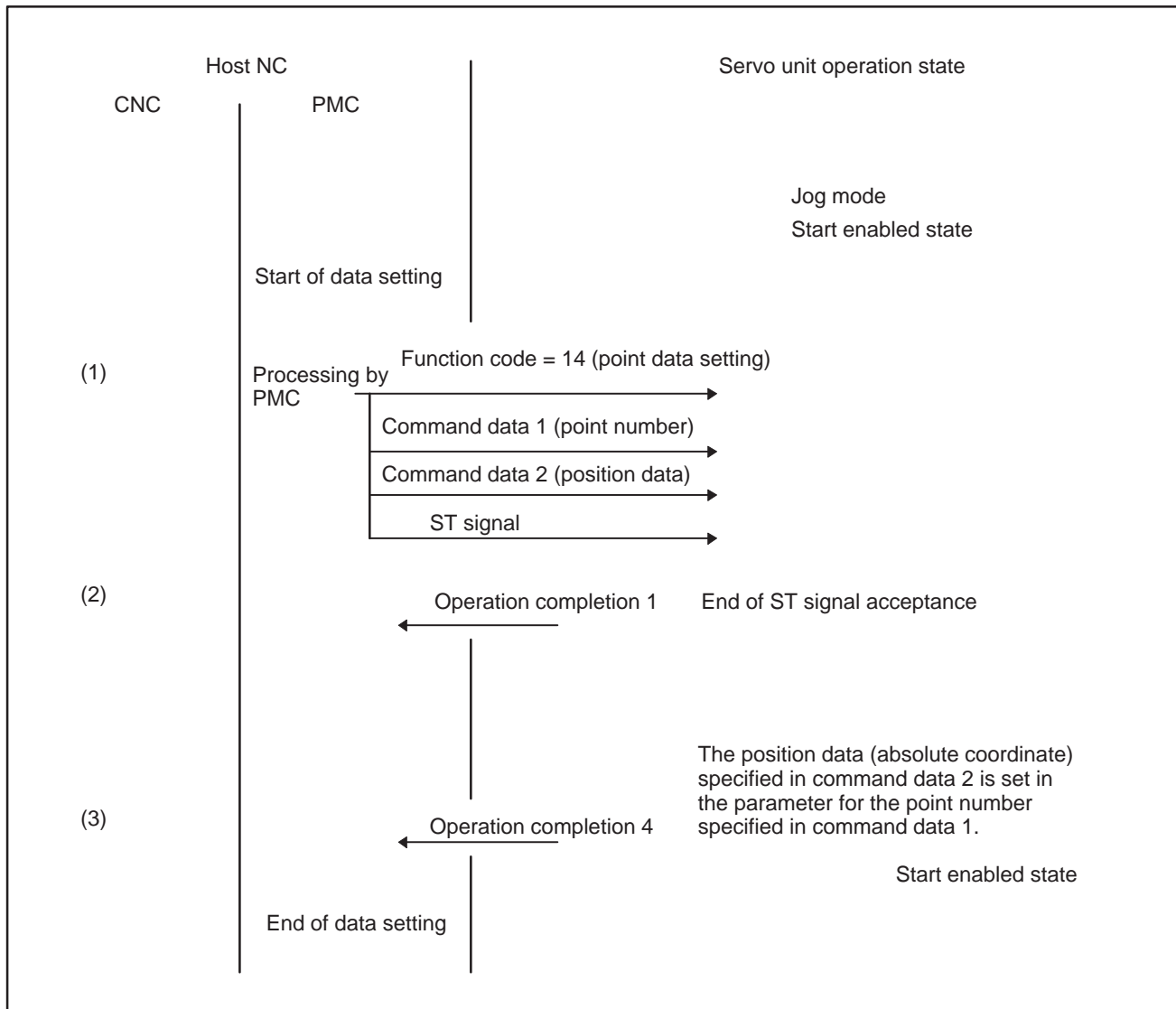

- (1) In data setting, the PMC on the host NC sets the function code, command data 1, and command data 2, then sends the ST signal to the servo unit.
- (2) When the function code, command data 1, and command data 2 are received, the servo unit returns the operation completion 1 signal to the NC.
- (3) Upon the completion of setting data in the parameter, the servo unit returns the operation completion 4 signal.

Supplementary information

- 1) The start enabled state is that state in which the STL signal is off.

4

DIRECT COMMANDS



4.1 DIRECT COMMAND FORMAT

- **General format of instruction commands (host → servo unit)**

The servo unit receives a command issued in the specified format from the host, then executes the command. After command execution, the servo unit returns the result of command execution to the host. Such commands are called direct commands. These commands are set in an interface area in the formats shown below.

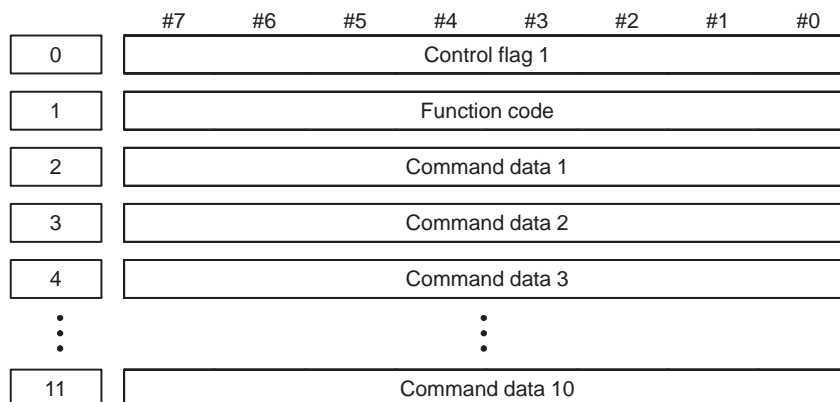

- **General format of response commands (servo unit → host)**

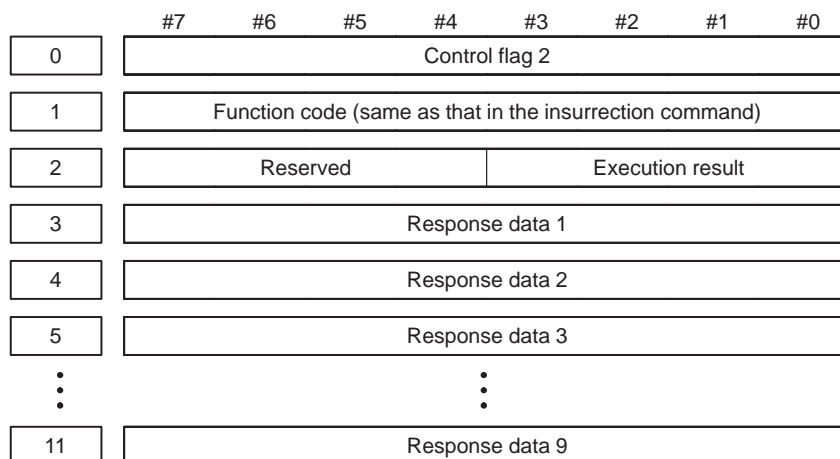

- Data types

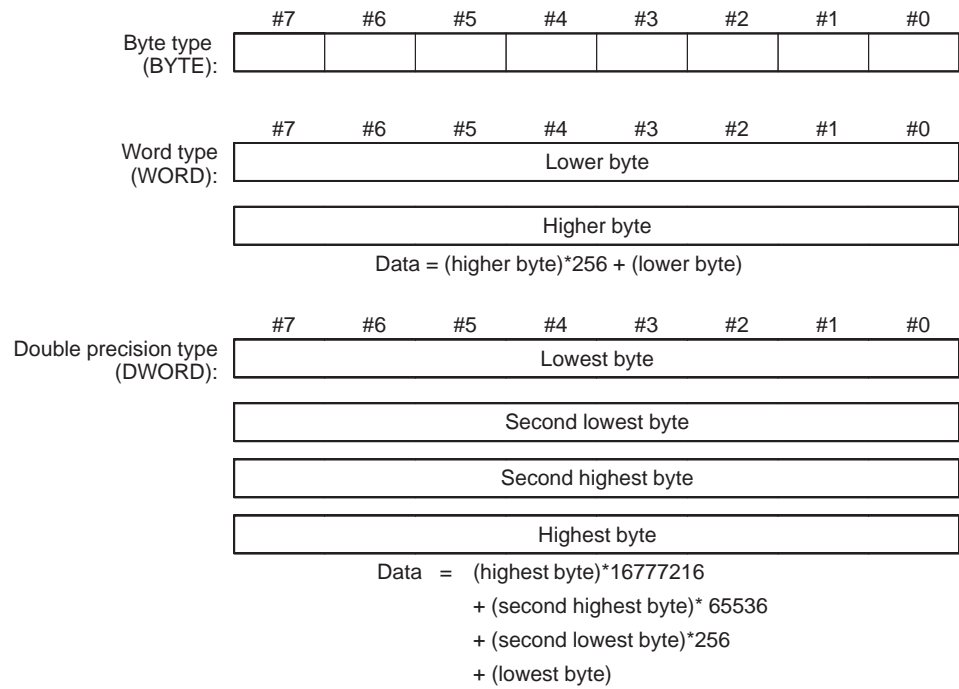

4.2 DIRECT COMMAND CONTROL PROCEDURE

4.2.1 Direct Command Control Procedure

Direct commands are classified into two types: instruction commands which are sent from the host to a servo unit, and response commands which are returned from a servo unit to the host. Such command transfer is controlled using two flags, control flag 1 and control flag 2. Control flag 1 is sent from the host to a servo unit. Control flag 2 is returned from a servo unit to the host.

	#7	#6	#5	#4	#3	#2	#1	#0
Control flag 1	EBUF	EOREND						ECNT
Control flag 2	EBSY	EOSTB	ECF		USR1	EOPC	AL	ECONT

4.2.2 Instruction Command Control (EBUF, EBSY, and ECNT)

Instruction commands sent from the host to a servo unit are controlled with EBUF and EBSY.

When the EBUF and EBSY states (values) match, the host can write a command into the interface area. After writing the command, the host inverts EBUF.

If the EBUF and EBSY states differ, the servo unit assumes that a new command has been specified.

Therefore, control flag 1 must be written last after a function number and command data are written. After the servo unit reads the command, it inverts the EBSY state.

EBUF is initially set to 0.

Since the instruction command data area is limited, instruction command data sometimes cannot be sent if the amount of data is excessive. In such a case, more than one instruction command must be issued to send all the data. If there is an additional instruction command to be sent, ECNT is set to 1 to indicate that another command follows.

CAUTION

When the power motion manager function is used, the inverted EBSY state is posted to the host for 40 ms. This duration can be changed by parameter setting (parameter No. 022).

4.2.3 Response Command Control (EOREND, EOSTB, EOPC, USR1, and ECONT)

Response commands returned from the servo unit are controlled with EOREND, EOSTB, and EOPC. EOPC indicates that the response command is in continuous read mode.

The host reads response data according to the following control procedure:

When the EOREND state and EOSTB state do not match, the host can read response data. After reading the data, the host inverts EOREND such that the EOREND state matches the EOSTB state. As EOREND is inverted, the servo unit regards the data read operation as having been completed.

When the amount of data in a response command is too great to enable the sending of all the data at one time, ECONT indicates 1. In this case, after reading the current data, the host inverts EOREND such that it matches the EOSTB state, then waits for the next data. The host must read the data repeatedly until ECONT becomes 0.

CAUTION

When the power motion manager function is used, the area used by the power motion manager function is also used simultaneously by the direct commands of the PMC ladder program to exchange the data. USR1 being set to 0 indicates that the data in the area is a response to the ladder program, so read processing must be performed. USR1 being set to 1 indicates that data in the area is a response to the power motion manager and is to be ignored.

4.2.4 Command Completion Notification (ECF)

When NMOD is set to 1 for an instruction command, the command is executed in completion notification mode. This means that the servo unit notifies the host that execution of the instruction command has been completed, and the servo unit does not execute the next command until the servo unit receives a response from the host.

- (1) Upon the completion of command execution, the servo unit sets ECF to 1.
- (2) The host issues the FIN instruction command to notify the servo unit that the host has received completion notification.

CAUTION

When the power motion manager function is used, ECF being set to 1 is posted to the host for 40 ms. This duration can be changed by parameter setting (parameter No. 022).

4.2.5 Alarm (AL)

If an alarm is issued in the servo unit, AL is set to 1. When detailed information about the alarm is required, the host specifies the READ ALARM STATUS command.

4.2.6 Direct Command Execution Result

The servo unit returns the result of execution using the following code. Upon the reception of an execution result, the host performs appropriate processing such as error display and retry operation.

Completion code	Meaning	Description (action)
0	Normal termination	
1	Execution error	Execution was attempted with no program. Start of execution was attempted during execution.
2	Data length error	Direct command has an illegal command format.
3	Incorrect number of data items	Direct command has an illegal command format.
4	Data attribute error	Direct command has an illegal command format.
7	Write protect error	
8	Memory overflow	
9	Parameter error	An illegal parameter is set.
10	Buffer control error	
12	Mode select error	
14	Reset or halted	
15	Execution in progress	

4.3 DIRECT COMMANDS

Function	Function code	Subsection to be referenced
1. Signal operation commands		
(1) Setting and releasing the torque limit enable signal	0x0C	4.4.1 (1)
(2) Specifying the torque limit value	0x91	4.4.1 (2)
2. Parameters		
(1) Reading parameters	0x20	4.4.2 (1)
(2) Writing parameters	0x21	4.4.2 (2)
3. Status read		
(1) Reading the absolute position	0x30	4.4.3 (1)
(2) Reading the machine position	0x31	4.4.3 (2)
(3) Reading the servo delay	0x33	4.4.3 (3)
(4) Reading the servo acceleration/deceleration delay	0x34	4.4.3 (4)
(5) Reading the actual feedrate	0x36	4.4.3 (5)
(6) Reading the status	0x37	4.4.3 (6)
(7) Reading alarm information	0x38	4.4.3 (7)
(8) Reading data continuously	0x41	4.4.3 (8)
4. Axis movement commands		
(1) Reference position return	0x60	4.4.4 (1)
(2) Absolute positioning	0x61	4.4.4 (2)
(3) Incremental positioning	0x62	4.4.4 (3)
(4) Dwell	0x63	4.4.4 (4)
(5) Coordinate system setting	0x64	4.4.4 (5)
(6) Acquiring the FIN state	0x66	4.4.4 (6)
(7) FIN command	0x67	4.4.4 (7)
(8) Wait command	0x90	4.4.4 (8)

4.4 DETAILS OF DIRECT COMMAND FUNCTIONS

4.4.1

Signal Operation Commands

- (1) Setting and releasing the torque limit enable signal
The host specifies the setting and release of the torque limit enable signal.

- Instruction command format

	#7	#6	#5	#4	#3	#2	#1	#0	
0	Control flag 1								
1	0	0	0	0	1	1	0	0	(0x0C)
2	0	0	0	1	0	0	0	SET	

- SET** 0: Releases the torque limit enable signal.
 1: Sets the torque limit enable signal.

- Response command format

This command has no response data.

- (2) Specifying the torque limit value
The host specifies the torque limit value when the torque limit is enabled.

- Instruction command format

	#7	#6	#5	#4	#3	#2	#1	#0	
0	Control flag 1								
1	1	0	0	1	0	0	0	1	(0x91)
2	0	0	0	1	0	0	0	0	
3	TRQ LIMIT								
4	TRQ LIMIT								

TRQ LIMIT : 0 to 7282 (torque limit value)

- Response command format

This command has no response data.

4.4.2 Parameters

- (1) Reading parameters
The host can read parameters for the servo unit.

- Instruction command format

	#7	#6	#5	#4	#3	#2	#1	#0	
0	Control flag 1								
1	0	0	1	0	0	0	0	0	(0x20)
2	Parameter No. (word type)								
3	Parameter No. (word type)								

- Response command format

Byte type

	#7	#6	#5	#4	#3	#2	#1	#0	
0	Control flag 2								
1	0	0	1	0	0	0	0	0	(0x20)
2	Reserved				Execution result				
3	Data length (byte type) = 1								
4	Parameter (byte type)								

Word type

	#7	#6	#5	#4	#3	#2	#1	#0	
0	Control flag 2								
1	0	0	1	0	0	0	0	0	(0x20)
2	Reserved				Execution result				
3	Data length (byte type) = 2								
4	Parameter (word type)								
5	Parameter (word type)								

DWORD type

	#7	#6	#5	#4	#3	#2	#1	#0	
0	Control flag 2								
1	0	0	1	0	0	0	0	0	(0x20)
2	Reserved				Execution result				
3	Data length (byte type) = 4								
4	Parameter (DWORD type)								
5	Parameter (DWORD type)								
6	Parameter (DWORD type)								
7	Parameter (DWORD type)								

(2) Writing parameters

The host can write parameters for the servo unit.

CAUTION

Writing parameters from the host is prohibited while the servo unit is operating.

- Instruction command format

Byte type

	#7	#6	#5	#4	#3	#2	#1	#0	
0	Control flag 1								
1	0	0	1	0	0	0	0	1	(0x21)
2	Parameter No. (word type)								
3	Parameter No. (word type)								
4	0	0	0	0	0	0	0	1	
5	Data length (byte type) = 1								
6	Parameter (byte type)								

Word type

	#7	#6	#5	#4	#3	#2	#1	#0	
0	Control flag 1								
1	0	0	1	0	0	0	0	1	(0x21)
2	Parameter No. (word type)								
3	Parameter No. (word type)								
4	0	0	0	0	0	0	0	1	
5	Data length (byte type) = 2								
6	Parameter (word type)								
6	Parameter (word type)								

DWORD type

	#7	#6	#5	#4	#3	#2	#1	#0	
0	Control flag 1								
1	0	0	1	0	0	0	0	1	(0x21)
2	Parameter No. (word type)								
3	Parameter No. (word type)								
4	0	0	0	0	0	0	0	1	
5	Data length (byte type) = 4								
6	Parameter (DWORD type)								
7	Parameter (DWORD type)								
8	Parameter (DWORD type)								
9	Parameter (DWORD type)								

- Response command format

	#7	#6	#5	#4	#3	#2	#1	#0	
0	Control flag 2								
1	0	0	1	0	0	0	0	1	(0x21)
2	Reserved				Execution result				

4.4.3

Status Read

(1) Reading the absolute position

The host can read the absolute position of the servo unit.

- Instruction command format

	#7	#6	#5	#4	#3	#2	#1	#0	
0	Control flag 1								
1	0	0	1	1	0	0	0	0	(0x30)
2	0	0	0	0	0	0	0	1	

- Response command format

	#7	#6	#5	#4	#3	#2	#1	#0	
0	Control flag 2								
1	0	0	1	1	0	0	0	0	(0x30)
2	Reserved				Execution result				
3	Axis data (DWORD type)								
4	Axis data (DWORD type)								
5	Axis data (DWORD type)								
6	Axis data (DWORD type)								

- (2) Reading the machine position
The host can read the machine position of the servo unit.

● Instruction command format

	#7	#6	#5	#4	#3	#2	#1	#0	
0	Control flag 1								
1	0	0	1	1	0	0	0	1	(0x31)
2	0	0	0	0	0	0	0	1	

● Response command format

	#7	#6	#5	#4	#3	#2	#1	#0	
0	Control flag 2								
1	0	0	1	1	0	0	0	1	(0x31)
2	Reserved				Execution result				
3	Axis data (DWORD type)								
4	Axis data (DWORD type)								
5	Axis data (DWORD type)								
6	Axis data (DWORD type)								

- (3) Reading the servo delay
The host can read the servo delay in the servo unit.

● Instruction command format

	#7	#6	#5	#4	#3	#2	#1	#0	
0	Control flag 1								
1	0	0	1	1	0	0	1	1	(0x33)
2	0	0	0	0	0	0	0	1	

● Response command format

	#7	#6	#5	#4	#3	#2	#1	#0	
0	Control flag 2								
1	0	0	1	1	0	0	1	1	(0x33)
2	Reserved				Execution result				
3	Axis data (DWORD type)								
4	Axis data (DWORD type)								
5	Axis data (DWORD type)								
6	Axis data (DWORD type)								

- (4) Reading the servo acceleration/deceleration delay
The host can read the servo acceleration/deceleration delay in the servo unit.

● **Instruction command format**

	#7	#6	#5	#4	#3	#2	#1	#0	
0	Control flag 1								
1	0	0	1	1	0	1	0	0	(0x34)
2	0	0	0	0	0	0	0	1	

● **Response command format**

	#7	#6	#5	#4	#3	#2	#1	#0	
0	Control flag 2								
1	0	0	1	1	0	1	0	0	(0x34)
2	Reserved				Execution result				
3	Axis data (DWORD type)								
4	Axis data (DWORD type)								
5	Axis data (DWORD type)								
6	Axis data (DWORD type)								

- (5) Reading the actual feedrate
The host can read the actual feedrate of the servo unit.

● **Instruction command format**

	#7	#6	#5	#4	#3	#2	#1	#0	
0	Control flag 1								
1	0	0	1	1	0	1	1	0	(0x36)

● **Response command format**

	#7	#6	#5	#4	#3	#2	#1	#0	
0	Control flag 2								
1	0	0	1	1	0	1	1	0	(0x36)
2	Reserved				Execution result				
3	Feedrate (DWORD type)								
4	Feedrate (DWORD type)								
5	Feedrate (DWORD type)								
6	Feedrate (DWORD type)								

- (6) Reading the status
The host can read the execution status of the servo unit (such as the mode being selected and the alarm state).

● **Instruction command format**

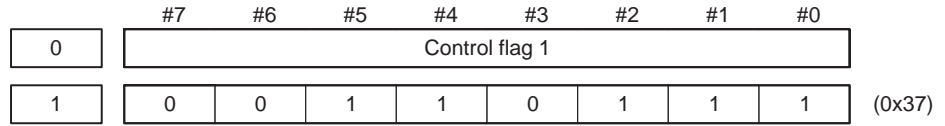

● **Response command format**

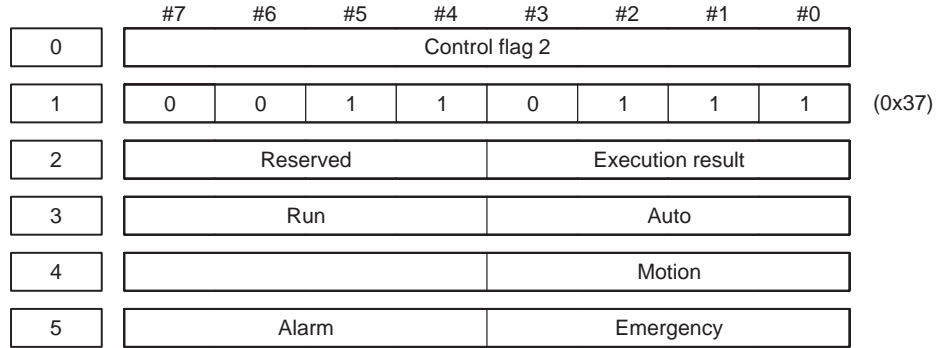

- Auto** : 1 AUTO
4 HANDLE
5 JOG
- Run** : 0 (reset)
1 STOP
3 START
- Motion** : 0 ***
2 DWL
1 MTN
- Emergency** : 0 ****
2 RSET
- Alarm** : 1 EMG
2 BAT
1 ALM

(7) Reading alarm information
 When an alarm is issued in the servo unit, the host can read the alarm number of the alarm.

● **Instruction command format**

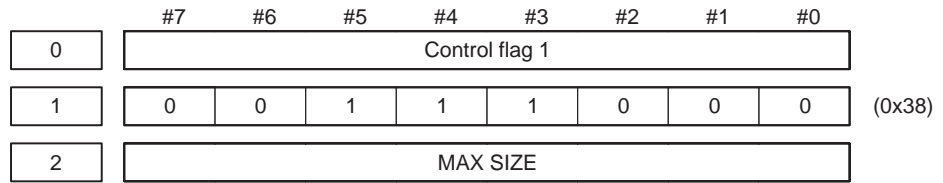

● **Response command format**

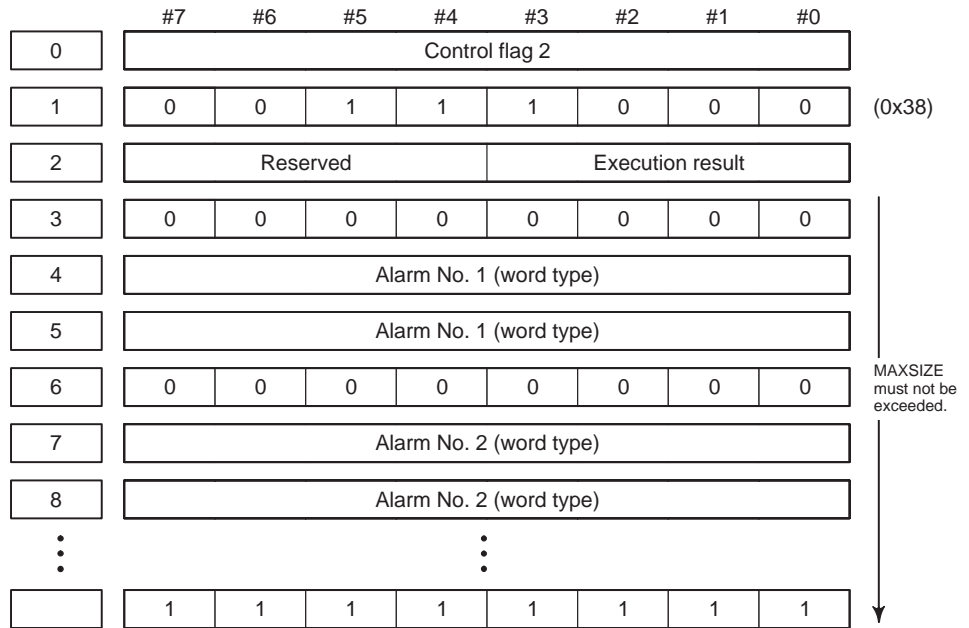

MAX SIZE : Maximum size (9 or less)

- (8) Reading data continuously
The host can read servo unit status data such as the absolute position, machine position, and servo delay, continuously.

● **Instruction command format**

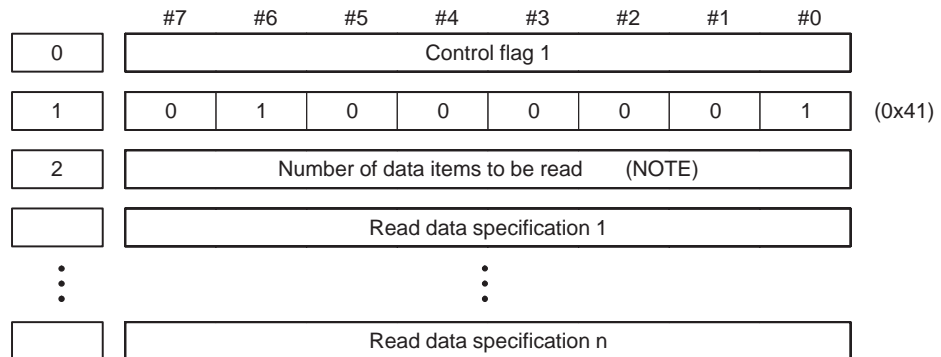

NOTE

Up to four data items can be specified for reading. When continuous read operation is canceled, the host sets 0 as the number of data items.

● **Response command format**

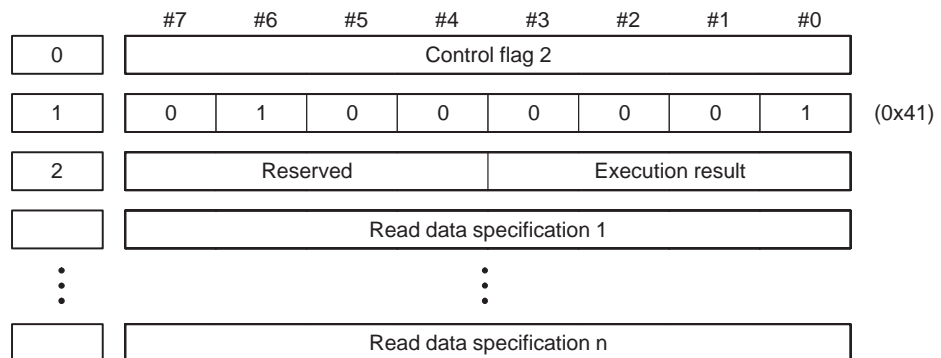

CAUTION

The data length varies according to the specified data.

The types of data to be read continuously are specified using the following codes. The read data format for each code is also shown below.

- | | |
|---|------|
| (a) Reading the absolute coordinates | 0x01 |
| (b) Reading the machine coordinates | 0x02 |
| (c) Reading the servo position deviation | 0x03 |
| (d) Reading the accumulated pulses in acceleration/deceleration | 0x04 |
| (e) Reading the actual feedrate | 0x05 |
| (f) Reading the slave status | 0x06 |

(a) Reading the absolute coordinates 0x01

• Data specification code for continuous read

	#7	#6	#5	#4	#3	#2	#1	#0	
0	0	0	0	0	0	0	0	1	(0x01)
1	0	0	0	0	0	0	0	1	

• Continuous read data format

	#7	#6	#5	#4	#3	#2	#1	#0	
0	0	0	0	0	0	0	0	1	(0x01)
1	Reserved				Execution result				
2	Axis data (DWORD type)								
3	Axis data (DWORD type)								
4	Axis data (DWORD type)								
5	Axis data (DWORD type)								

(b) Reading the machine coordinates 0x02

• Data specification code for continuous read

	#7	#6	#5	#4	#3	#2	#1	#0	
0	0	0	0	0	0	0	1	0	(0x02)
1	0	0	0	0	0	0	0	1	

• Continuous read data format

	#7	#6	#5	#4	#3	#2	#1	#0	
0	0	0	0	0	0	0	1	0	(0x02)
1	Reserved				Execution result				
2	Axis data (DWORD type)								
3	Axis data (DWORD type)								
4	Axis data (DWORD type)								
5	Axis data (DWORD type)								

(c) Reading the servo position deviation 0x03

• Data specification code for continuous read

	#7	#6	#5	#4	#3	#2	#1	#0	
0	0	0	0	0	0	0	1	1	(0x03)
1	0	0	0	0	0	0	0	1	

• Continuous read data format

	#7	#6	#5	#4	#3	#2	#1	#0	
0	0	0	0	0	0	0	1	1	(0x03)
1	Reserved				Execution result				
2	Axis data (DWORD type)								
3	Axis data (DWORD type)								
4	Axis data (DWORD type)								
5	Axis data (DWORD type)								

(d) Reading the accumulated pulses in acceleration/deceleration 0x04

• Data specification code for continuous read

	#7	#6	#5	#4	#3	#2	#1	#0	
0	0	0	0	0	0	1	0	0	(0x04)
1	0	0	0	0	0	0	0	1	

• Continuous read data format

	#7	#6	#5	#4	#3	#2	#1	#0	
0	0	0	0	0	0	1	0	0	(0x04)
1	Reserved				Execution result				
2	Axis data (DWORD type)								
3	Axis data (DWORD type)								
4	Axis data (DWORD type)								
5	Axis data (DWORD type)								

(e) Reading the actual feedrate 0x05

• Data specification code for continuous read

	#7	#6	#5	#4	#3	#2	#1	#0	
0	0	0	0	0	0	1	0	1	(0x05)

• Continuous read data format

	#7	#6	#5	#4	#3	#2	#1	#0	
0	0	0	0	0	0	1	0	1	(0x05)
1	Reserved				Execution result				
2	Feedrate (DWORD type)								
3	Feedrate (DWORD type)								
4	Feedrate (DWORD type)								
5	Feedrate (DWORD type)								

(f) Reading the slave status 0x06

• Data specification code for continuous read

	#7	#6	#5	#4	#3	#2	#1	#0	
0	0	0	0	0	0	1	1	0	(0x06)

• Continuous read data format

	#7	#6	#5	#4	#3	#2	#1	#0	
0	0	0	0	0	0	1	1	0	(0x06)
1	Reserved				Execution result				
2	Run				Auto				
3					Motion				
4	Alarm				Emergency				

- Auto** : 1 AUTO
4 HANDLE
5 JOG
- Run** : 0 (reset)
1 STOP
3 START
- Motion** : 0 ***
2 DWL
1 MTN
- Emergency** : 0 ***
1 —EMerGency—
2 —RESET—
- Alarm** : 0 ***
1 ALarM
2 BATery low

4.4.4 Axis Movement Commands

Axis movement commands are executed in AUTO mode.

CAUTION

Do not change the mode during operation. Change the mode only after operation stops.

(1) Reference position return

This command instructs the servo unit to perform reference position return. When the reference position has not yet been established, movement is performed in the reference position return direction (bit 5 (ZMIX) of parameter No. 010) at low speed (set in parameter No. 054), then stops at the first grid point. This position is set as the reference position.

When the reference position has already been established, return to the reference position is performed at high speed (rapid traverse rate).

● **Instruction command
format**

	#7	#6	#5	#4	#3	#2	#1	#0	
0	Control flag 1								
1	0	1	1	0	0	0	0	0	(0x60)
2	0	0	0	0	NMOD	0	0	0	
3	0	0	0	0	0	0	0	1	

NMOD = 1: Execution completion notification mode
(For details, see Section 4.2.)

● **Response command
format**

This command has no response data.

(2) Absolute positioning

This command instructs the servo unit to perform absolute positioning. The motor moves through an amount equal to the difference between a specified absolute position and the current position.

- **Instruction command format**

	#7	#6	#5	#4	#3	#2	#1	#0	
0	Control flag 1								
1	0	1	1	0	0	0	0	1	(0x61)
2	0	0	0	0	NMOD	0	0	1	
3	0	RPD	0	0	0	0	0	1	
4	FEED RATE								
5	FEED RATE								
6	DISTANCE								
7	DISTANCE								
8	DISTANCE								
9	DISTANCE								

FEED RATE : 1 to 65535 (user-specified unit*10**N/min.)
N is set with parameter No. 21.

DISTANCE (absolute position):
-99999999 to 99999999 (user-specified unit)

NMOD =1 : Execution completion notification mode
(For details, see Section 4.2.)

RPD =1 : Rapid traverse

- **Response command format**

This command has no response data.

(3) Incremental positioning

This command instructs the servo unit to perform incremental positioning. The motor moves through a specified amount of travel.

- **Instruction command format**

	#7	#6	#5	#4	#3	#2	#1	#0	
0	Control flag 1								
1	0	1	1	0	0	0	1	0	(0x62)
2	0	0	0	0	NMOD	0	0	1	
3	0	RPD	0	0	0	0	0	1	
4	FEED RATE								
5	FEED RATE								
6	DISTANCE								
7	DISTANCE								
8	DISTANCE								
9	DISTANCE								

FEED RATE : 1 to 65535 (user-specified unit*10**N/min.)
N is set with parameter No. 21.

DISTANCE (incremental position);
-99999999 to 99999999 (user-specified unit)

NMOD =1 : Execution completion notification mode
(For details, see Section 4.2.)

RPD =1 : Rapid traverse

- **Response command format**

This command has no response data.

(4) Dwell

This command instructs the servo unit to perform dwell. The execution of the next block can be delayed by a specified amount of time.

- **Instruction command format**

	#7	#6	#5	#4	#3	#2	#1	#0	
0	Control flag 1								
1	0	1	1	0	0	0	1	1	(0x63)
2	0	0	0	0	NMOD	0	0	1	
3	0	0	0	0	0	0	0	1	
4	DWELL TIME								
5	DWELL TIME								
6	DWELL TIME								
7	DWELL TIME								

DWELL TIME : 1 to 99999999 (msec)

NMOD =1 : Execution completion notification mode
(For details, see Section 4.2.)

- **Response command format**

This command has no response data.

(5) Setting a coordinate system

The absolute position of the servo unit is preset at a specified coordinate value.

- **Instruction command format**

	#7	#6	#5	#4	#3	#2	#1	#0	
0	Control flag 1								
1	0	1	1	0	0	1	0	0	(0x64)
2	0	0	0	0	NMOD	0	0	1	
3	0	0	0	0	0	0	0	1	
4	COORDINATE VALUE								
5	COORDINATE VALUE								
6	COORDINATE VALUE								
7	COORDINATE VALUE								

COORDINATE VALUE:

–99999999 to 99999999 (user-specified unit)

NMOD =1 : Execution completion notification mode
(For details, see Section 4.2.)

- **Response command format**

This command has no response data.

- (6) Acquiring the FIN state
The host issues this command to check whether the servo unit is waiting for FIN in command completion notification mode.

● Instruction command format

	#7	#6	#5	#4	#3	#2	#1	#0	
0	Control flag 1								
1	0	1	1	0	0	1	1	0	(0x66)

● Response command format

	#7	#6	#5	#4	#3	#2	#1	#0	
0	Control flag 2								
1	0	1	1	0	0	1	1	0	(0x66)
2	Reserved				Execution result				
3								ECF0	

ECF0 = 1 : Command completed (waiting for the FIN command)

CAUTION

This command is valid when command completion notification mode is set (NMOD = 1).

- (7) FIN command
If the servo unit is waiting for FIN in command completion notification mode, the host issues this command to release the FIN wait state.

● Instruction command format

	#7	#6	#5	#4	#3	#2	#1	#0	
0	Control flag 1								
1	0	1	1	0	0	1	1	1	(0x67)
2								ECFIN0	

ECFIN0 : FIN specification
If the servo unit is waiting for FIN (ECF0 = 1) in command completion notification mode, the host responds with this command.

● Response command format

	#7	#6	#5	#4	#3	#2	#1	#0	
0	Control flag 2								
1	0	1	1	0	0	1	1	1	(0x67)
2	Reserved				Execution result				

(8) Wait command

This command instructs the servo unit to wait. When this command is executed, the servo unit outputs wait signal WAT [2.3.14 (14)] to the host, then enters the wait state. To release the wait state, the host sets wait completion signal WFN [2.3.14 (15)] to 1. Then, the servo unit sets the WAT signal to 0. As the host confirms that the WAT signal has been set to 0, the host sets the WFN signal to 0. Then, the wait state is released, and the servo unit executes the next block.

- Instruction command format

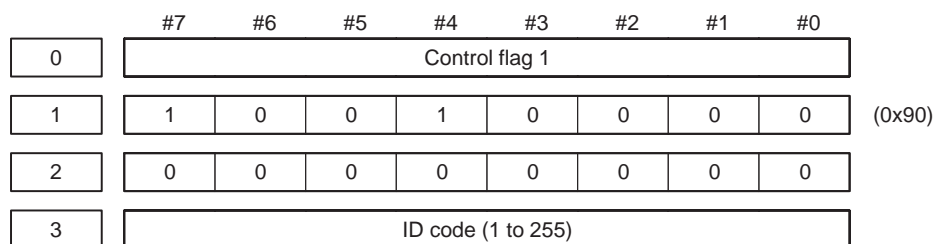

- Response command format

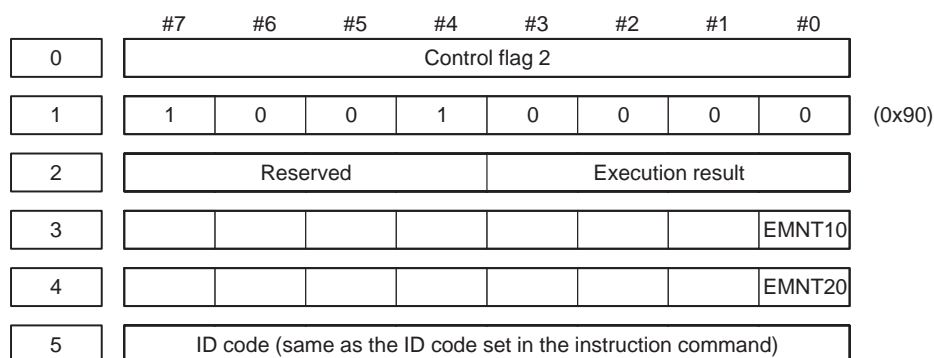

EMNT10 and EMNT20 indicate the β amplifier execution buffer status when the instruction command is read.

EMNT20	EMNT10	Status
0	0	All buffers are empty.
0	1	Buffer 1 is being used, and buffer 2 is empty.
1	0	Buffer 1 is empty, and buffer 2 is being used.
1	1	All buffers are being used.

CAUTION

- 1 The ID code in the instruction command is valid when bit 5 (WAT2) of parameter No. 003 is set to 1.
- 2 The response command is output when bit 5 (WAT2) of parameter No. 003 is set to 1. When the response command is output, the host reads the ID code, and answers by inverting response data read completion signal EOREND [2.3.14 (18)]. After answering, the host confirms the WAT signal, and changes the WFN signal state from 0 to 1 to 0.

4.5 THIRTY-TWO- BLOCK BUFFERING OPERATION

4.5.1 Outline

The host can register and execute up to 32 blocks of direct commands in the internal memory of the servo unit.

NOTE

One block consists of one instruction command which is a direct command.

4.5.2 Memory Registration Procedure

The host registers up to 32 blocks of direct commands in the internal memory of the β amplifier by means of the procedure explained below.

- (1) The host sets memory registration signal INPF [2.3.14 (16)] to 1.
- (2) After confirming that memory registration in-progress signal INPFO [2.3.14 (17)] has been set to 1, the host registers direct commands in the servo unit through EBUF/EBSY control.
- (3) Upon the completion of registration, the host sets memory registration signal INPF to 0.

CAUTION

The registered blocks are all erased when the INPF signal state is changed from 0 to 1. Also, the registered blocks are all erased when the power is disconnected.

NOTE

An attempt to register more than 32 blocks results in the issue of alarm 70. (" 70" appears on the LED indicator.)

4.5.3 Operation Procedure

The host operates and executes registered direct commands by means of the procedure explained below.

- (1) Select AUTO mode. (MD1 = 1, MD2 = 0, MD4 = 0 [2.3.4 (1)])
- (2) Change the status of automatic operation start signal ST [2.3.10 (1)] from 1 to 0. When the level of the ST signal falls, buffering operation starts. (It is also possible to start operation when the ST signal level rises by parameter setting (bit 7 (STON) of parameter No. 3)).

CAUTION

- 1 After the last block has been executed, operation is halted. To perform operation again from the first block, cause a reset to locate the first block, then start operation by using the ST signal. A reset causes the top of the registered blocks to be located.
- 2 During buffering, switching the ST signal state from 0 to 1 causes a single-block stop. To restart operation, change the ST signal state from 1 to 0.

5

EXTERNAL PULSE INPUT FUNCTION



5.1 OUTLINE

This function enables movement in sync with external pulses generated from the machine.

Apply external pulses via the external pulse input interface.

5.2 DETAILED DESCRIPTION

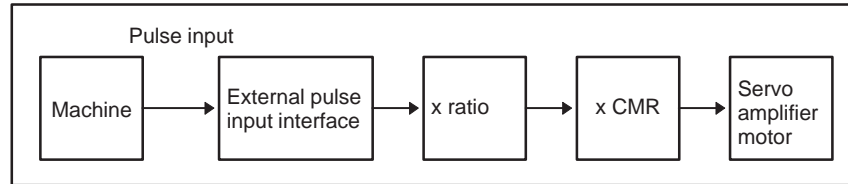

- (1) External pulses are applied via the external pulse input interface. The A-phase (PA, *PA) and B-phase (PB, *PB) signals are used for an input waveform as well as for a position coder output waveform. The C-phase signal is not required.
- (2) The ratio of the amount of travel along an axis to an external pulse can be set with parameters. The ratio is expressed as M/N (where, M = parameter magnification 1 (parameter No. 62), N = parameter magnification 2 (parameter No. 63)).
- (3) When the A-phase signal is 90° ahead of the B-phase signal, movement is performed in the positive direction.
When the A-phase signal lags 90° behind the B-phase signal, movement is performed in the negative direction.
- (4) Parameter setting (bit 6 (EXPLS) of parameter No. 3) determines whether to enable axis movement by external pulses.
- (5) For axis movement by external pulses, interlock and overtravel detection are valid.
- (6) The acceleration/deceleration type used for axis movement by external pulses is the same as that for jog feed. (Set bit 1 (JOG E) of parameter No. 2.)
- (7) Select external pulse input mode. This mode is selected when signal output is performed from the host to a servo unit (MD1 = 0, MD2 = 0, MD4 = 1 [2.3.4 (1)]).
- (8) If the feedrate for axis movement by external pulses exceeds the upper limit for a specified feedrate, as set in parameter No. 43, a choice of the following responses can be made by parameter setting (bit 6 (EPEXA) and bit 7 (EPEXB) of parameter No. 1):
 - a) The feedrate is clamped to the upper limit, and the excess pulses are accumulated. If the number of accumulated pulses exceeds 99999999, the excess pulses are discarded.
 - b) The feedrate is clamped to the upper limit, and the excess pulses are discarded.
 - c) Alarm 291 is issued, and movement is decelerated and stopped.

III. TROUBLESHOOTING AND COUNTERMEASURES

1

OVERVIEW



This part describes troubleshooting procedures to be applied in the event of a failure. If a failure occurs, determine the cause and apply an appropriate countermeasure while referring to the corresponding description in this manual.

First, check the LED display on the servo unit or the alarm number displayed on the host controller. Determine the cause and apply an appropriate countermeasure.



2

ALARM DISPLAY AND CORRESPONDING
COUNTERMEASURES











Number	Alarm type
000 to 255	Program or setting alarm
300 to 399	Pulse coder alarm
400 to 499	Servo alarm
500 to 599	Overtravel alarm
–	System alarm or I/O link alarm

Program or setting alarms (PS alarms)









No.	LED display	Description	Countermeasure
000		A parameter that requires power-down has been specified.	Turn the power off, then back on.
011		The specified feedrate is zero.	Check the feedrate parameter specified with a function code.
013		The specified feedrate (maximum feedrate) is zero.	Check the value of parameter No.043, which indicates the maximum feedrate that can be specified.
070		More than 32 blocks have been registered for a buffering operation.	Reduce the number of registered blocks to 32.
085		Input from the reader/punch interface or the like caused an overrun, parity, or framing error.	Correct the baud rate of the input/output unit (always 4800) or other settings.
086		Input from the reader/punch interface or the like includes an input/output unit operation ready signal (DR) that is set to off.	Turn the reader/punch on. Check the cable connection.
087		After input from the reader/punch interface or the like stops, character input does not stop even though ten characters have been input.	Check the cable connection.
090		Reference position setting cannot be executed normally.	Move the tool in the direction of reference position return in jog mode at a speed that causes the servo position error to exceed 128. Then, specify another reference position setting.
093		A first to third reference position return cannot be executed because the reference position has not yet been established.	Set the reference position.
224		The reference position has not yet been established. This occurs only when the ZRTN bit of parameter No.001 is set to 0.	Set the reference position.
250		Input data 1 is invalid.	Check input data 1, specified with a function code.
251		Input data 2 is invalid.	Check input data 2, specified with a function code.
255		Operation cannot be activated because an invalid mode is specified or because block execution is in progress.	Check the mode. Check whether a block is being executed.
290		The interface switch signal (DRC) was switched during block execution.	Switch the signal after block execution stops.







No.	LED display	Description	Countermeasure
291		The speed of an axial movement specified by an external pulse has exceeded the upper limit. This occurs only when the EPEXA bit of parameter No.001 is set to 1.	Check the speed specified by the external pulse. Check the magnification of the external pulse (parameters No.062 and 063).
292		A checksum error for the battery-powered memory was detected.	Parameters are cleared. Set the parameters again. If this alarm subsequently recurs, replace the unit.

Pulse coder alarms





No.	LED display	Description	Countermeasure
300		A communication error (DTER) for the serial pulse coder was detected.	Check the continuity of the signal cable. If the cable is normal, the pulse coder may be defective. Turn the power off. If the alarm recurs when the power is reapplied, replace the serial pulse coder, together with the motor.
301		A communication error (CRCER) for the serial pulse coder was detected.	Check the continuity of the signal cable. If the cable is normal, the pulse coder or servo unit may be defective. This error can also be caused by external noise. See the chapter on noise reduction in "Connection."
302		A communication error (STBER) for the serial pulse coder was detected.	Check the continuity of the signal cable. If the cable is normal, the pulse coder or servo unit may be defective. This error can also be caused by external noise. See the chapter on noise reduction in "Connection."
303		An LED disconnection (LDAL) was detected in the serial pulse coder.	Turn the power off. If this alarm recurs when the power is reapplied, replace the motor.
304		A mispulse alarm (PMAL) for the serial pulse coder was detected.	Turn the power off. If this alarm recurs when the power is reapplied, replace the motor.
305		A miscount alarm (CMAL) for the serial pulse coder was detected.	Turn the power off. If the alarm recurs when the power is re-applied, replace the motor. If the alarm does not recur, restart the operation from reference position return.
306		The motor has overheated (OHAL).	This alarm is issued when the amplifier has overheated, causing the thermostat to trip. Possible causes include an excessively high ambient temperature and excessively strict operating conditions. Check the actual cause. Disconnect the power for about ten minutes, then release the emergency stop state. If the alarm recurs, replace the amplifier.
308		A soft phase alarm (SPHAL) was detected.	Turn the power off. This alarm may be caused by noise.
319		When the absolute pulse coder is used, the motor has not yet rotated through more than one turn after the first power-up.	Cause the motor to rotate through more than one turn in jog feed mode, then turn the power off then back on.
350		The battery voltage of the absolute pulse coder is low.	Replace the battery. Restart the operation from reference position return.
351		The battery voltage of the absolute pulse coder is low. (warning)	Replace the battery.

Servo alarms







No.	LED display	Description	Countermeasure
400		The servo motor has overheated (estimated value).	Turn the power off. After a while, turn the power back on. Possible causes include an excessively high acceleration/deceleration frequency.
401		Servo amplifier ready signal (DRDY) went off.	
403		The cooling fins have overheated. (hardware detection)	The load on the motor may be too high. Re-examine the load conditions.
404		The regenerative discharge unit has overheated.	This alarm is issued when the average regenerative discharge energy is too high (when the acceleration/deceleration frequency is too high, for example).
		When the regenerative discharge resistor is not being used, check whether a dummy connector is fitted to the CX11-6 connector. When the regenerative discharge resistor is being used, (1) The average regenerative discharge energy may be too high. Decrease the acceleration/deceleration frequency. (2) The thermostat line of the separate regenerative discharge unit may not be connected properly. Check the connection. (3) The thermostat of the separate regenerative discharge unit may be defective. Disconnect the separate regenerative discharge unit, then check the thermostat. If the thermostat is open even through the separate regenerative discharge unit is cool, replace the separate regenerative discharge unit. If (1) to (3) are not the cause of the alarm, replace the servo amplifier.	
405		Reference position return could not be executed correctly.	Re-execute reference position return.
410		The servo position error in the stop state is larger than the value specified in parameter No.110.	Determine the mechanical cause of the large position error. If no mechanical cause is found, specify a larger value for the parameter.
411		The servo position error during movement is larger than the value specified in parameter No.182.	Determine the mechanical cause of the large position error. If no mechanical cause is found, apply any of the following countermeasures: <ul style="list-style-type: none"> • Specify a larger value for the parameter. • Specify a lower feedrate. • Increase the time constants.
412		An overcurrent alarm is issued.	This alarm is issued when an excessively large current flows in the main circuit.
		(1) Check whether a valid motor number is specified in parameter No.30. <ul style="list-style-type: none"> • If yes, go to (2). (2) Check whether the standard values are specified in the current control parameters for servo control. Correct current control is possible only when the standard values are specified for the following parameters: No.70, 71, 72, 78, 79, 84, 85, 86, 87, 88, 89, 90 (3) Disconnect the power line from the amplifier connector. Then, release the emergency stop state. <ul style="list-style-type: none"> – If the overcurrent alarm continues to be issued, replace the amplifier. – If no overcurrent alarm is issued, go to (4). (4) Disconnect the power line from the amplifier connector. Check the insulation between the ground and each of U, V, and W. If the insulation is satisfactory, go to (5). If a short-circuit is detected, disconnect the power line from the motor connector. Then, check the insulation between the ground and each of U, V, and W of the motor. If a short-circuit is found between the ground and U, V, or W of the motor, replace the motor. If the insulation is satisfactory, replace the power line. (5) Connect the power line. Observe the waveform of the motor current (IR, IS) while the motor is accelerating or decelerating. See the description of the checking of the motor current in Appendix E, "Servo Check Board". If the motor current (IR, IS) does not exhibit a normal sine wave, replace the amplifier. (6) If (1) to (4) above are not the cause of the alarm, the pulse coder, command cable, or internal hardware of the CNC may be defective.	

No.	LED display	Description	Countermeasure
413		A DC link overvoltage alarm is issued.	This alarm is issued when the DC voltage of the main circuit power is too high.
		(1) The supply voltage for dynamic power may exceed the rated value. Check the voltage. If the voltage is too high, reduce the voltage to an appropriate level. (2) The regenerative discharge unit may not be properly connected. Check the connection. (3) The resistance of the separate regenerative discharge unit may be abnormal. Disconnect the separate regenerative discharge unit, then check the resistance. If the resistance is not within +20% of the predetermined resistance, replace the separate regenerative discharge unit. If (1) to (3) are not the cause of the alarm, replace the servo amplifier.	
414		A DC link low voltage alarm is issued.	This alarm is issued when the DC voltage of the main circuit power is too low.
		(1) The external circuit breaker may be turned off. Check the circuit breaker. (2) The supply voltage for dynamic power is lower than the rated value. Check the voltage. If the voltage is too low, increase it to an appropriate level. (3) The external magnetic contactor may not be connected properly. Check the connection. If (1) to (3) are not the cause of the alarm, replace the servo amplifier.	
417		A parameter has been specified incorrectly.	Check the following parameters: No.30: Is the specified motor type correct? No.31: Is the specified direction of rotation of the motor correct? No.106: Is the denominator of the number of pulses per single revolution of the motor 0? No.180: Is the specified reference counter capacity 0 or a negative value?
418		A DO alarm is issued.	Replace the servo unit.
423		The specified speed exceeds 32767000 detection units per second.	Re-examine the CMR and speed settings.
425		The cooling fan has stopped.	This alarm is issued when the fan motor built into the servo amplifier has failed.
		(1) Check that the fan is not clogged with foreign matter. (2) Check that the power connector of the fan is connected properly. (3) Replace the fan or servo unit.	

Overtravel alarms

No.	LED display	Description	Countermeasure
500		The positive stroke limit has been exceeded.	Check whether *+OT and *-OT are connected correctly. Check whether a correct move command is specified. Move the tool in the opposite direction in jog mode, then perform a reset.
501		The negative stroke limit has been exceeded.	
510		The positive soft stroke limit has been exceeded.	Check whether appropriate values have been specified for parameters No.142 and 143. Check whether a valid move command is specified. Move the tool in the opposite direction in jog mode, then perform a reset.
511		The negative soft stroke limit has been exceeded.	

System alarms

No.	LED display	Description	Countermeasure
-		An error was detected in the RAM write/read test at power-up.	Replace the unit.
-		An error was detected in the data collation check for the battery-powered memory.	Turn the power off then back on. Then, re-enter the parameters. If this alarm recurs, replace the unit.
-		A data transfer alarm for the battery-powered memory has been issued.	Replace the unit.
-		A watchdog alarm was issued.	Turn the power off then back on. If this alarm recurs, replace the unit.
-		A checksum alarm for the control software ROM is issued.	Replace the unit.
-		A checksum alarm for the ROM that is built into the CPU is issued.	Replace the unit.
-		An error was detected in the control circuit.	Replace the unit.

I/O link alarm

No.	LED display	Description	Countermeasure
-		A FANUC I/O link error occurred. A unit connected to the line was turned off.	Turn off the power to all units connected to the line. Then, turn on the slave devices, followed by the master device.

No LED display

No.	LED display	Description	Countermeasure
-	No indicators lit	The control circuit is not operating normally.	<p>(1) Check the 24-VDC control supply voltage. If the voltage is low, increase the voltage to an appropriate level.</p> <p>(2) Check whether a fuse in the servo unit has blown. If a blown fuse is found, replace it, following the procedure described in Section 3, "Replacing Fuse."</p> <p>If (1) and (2) are not the cause, replace the servo amplifier.</p>

3 REPLACING FUSE

Important

Before replacing a fuse, turn the power off. Check, on the front panel of the servo amplifier, that the red LED indicating charging in progress (see Appendix A) is not lit. Then, replace the fuse.

Replacement procedure

(1) Remove the plastic cover.
 (2) Replace the fuse near the CX11 connector on the power board (A20B-2100-0130 or -0131). (See Appendix A.)

Use	Component name	Number	Code
Fuse for control power	F600	1	FANUC order code: A06B-6073-K250 Manufacturer code: LM32, DC48V, F3.2A Daito Tsushinki

IV. MAINTENANCE OF SERVO UNIT

1

REPLACING BATTERY OF THE ABSOLUTE PULSE CODER

When an absolute pulse coder is used, a battery is provided for the absolute pulse coder. When the voltage of this battery falls, alarm 350 or 351 is issued. If alarm 351 is issued, replace the battery immediately. If the battery voltage falls further, the absolute position of the pulse coder cannot be stored. If the servo unit is turned on in this state, alarm 350 is issued. If this alarm is issued, replace the battery, then perform reference position return.

The battery is connected in either of the two ways shown below:

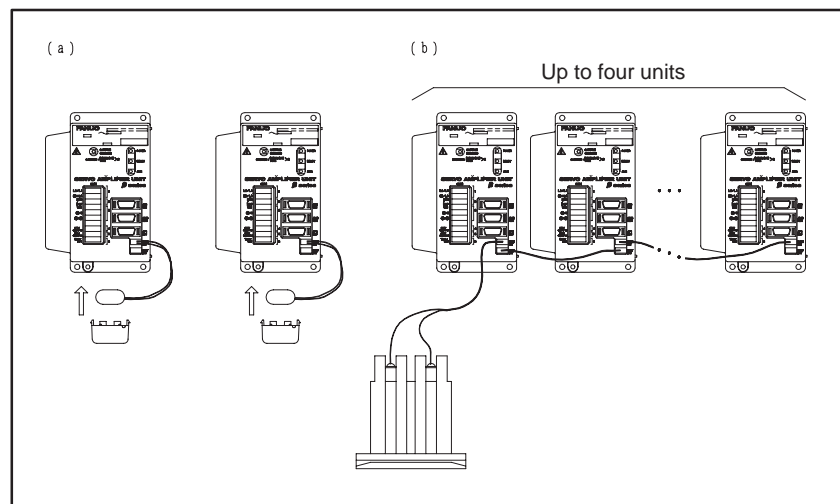

(a) 6-V lithium battery

1. Have a new 6-V lithium battery (order code: A98L-0031-0011#L) on hand.
2. Turn the servo unit (machine) on. (The battery must not be replaced while the power to the servo unit is off.) To prevent inadvertent operation of the machine while the battery is being replaced, take appropriate precautions. For example, place the unit in the emergency stop state.
3. Remove the battery cover under the servo unit by grasping its left and right sides.
4. Remove the connector from the battery.
5. Replace the battery, then re-attach the connector.
6. Mount the battery cover.
7. Turn the servo unit (machine) off.

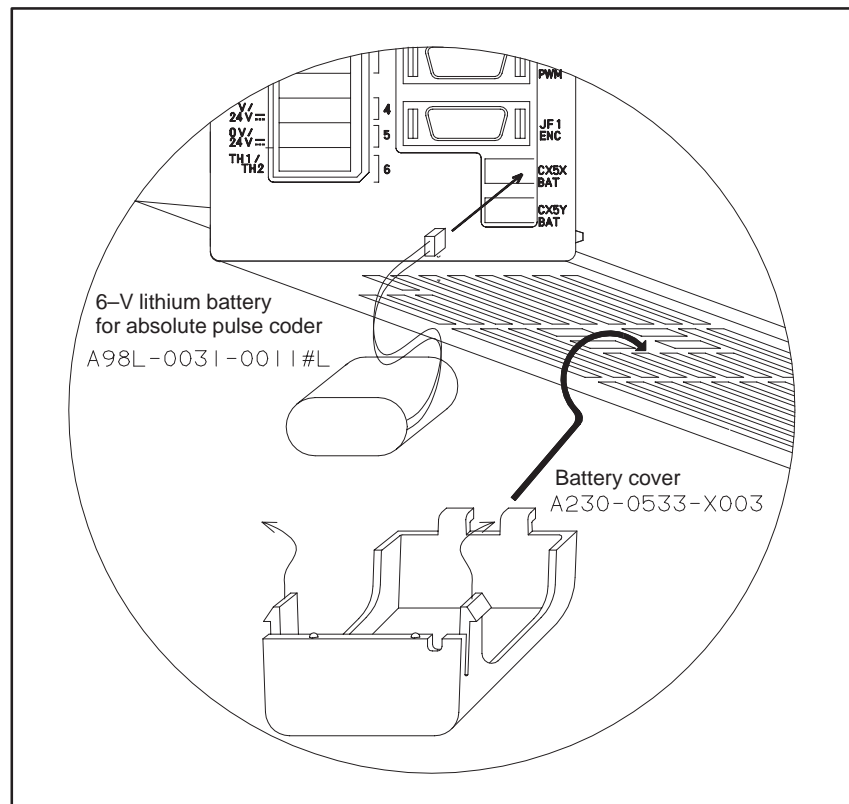

CAUTION

- 1 Replace the battery only while the power to the servo unit is on. If the battery is replaced while the power is off, all of the absolute position settings will be lost.
- 2 Ensure that the replacement battery is of the correct type. Otherwise, explosion or ignition will occur. Always use the specified battery (code: A98L-0031-0011#L).
- 3 The battery has a life of about one year. Even if a low-voltage alarm is not issued, replace the battery regularly at yearly intervals.

(b) Alkaline battery (D-size)

1. Have four D-size alkaline batteries on hand.
2. Turn the servo unit (machine) on. Replace the battery while the power to the servo unit is on. To prevent in advertent operation of the machine while the battery is being replaced, take appropriate precautions. For example, place the unit in the emergency stop state.
3. Loosen the screws on the battery case. Remove the cover.
4. Replace the dry cells in the case.
Orient the batteries as shown below. Pay careful attention to the polarity of the dry cells.

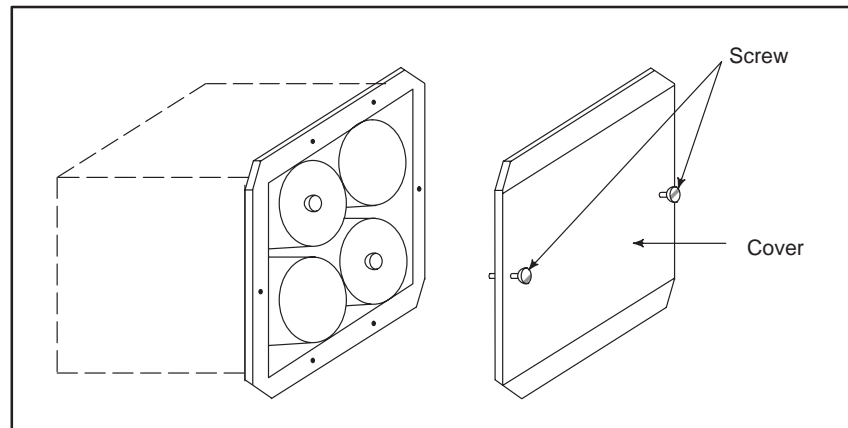

5. Attach the cover.
6. Turn the servo unit (machine) off.

CAUTION

- 1 Replace the batteries only while the power to the servo unit is on. If the batteries are replaced while the power is off, all the absolute position settings will be lost.
- 2 The batteries have a life of about one year. Even if a low-voltage alarm is not issued, replace the battery regularly at yearly intervals.

V. MAINTENANCE OF SERVO MOTOR

1

MAINTENANCE OF SERVO MOTOR



The β -series servo motors generally do not require periodic maintenance because the motors have no wearing components, such as the brushes of a DC motor. However, incorrect operation or damage during transportation or installation may result in a failure or problem. To prevent such a failure or problem, and to ensure that the servo motor remains in peak condition for as long as possible, periodic checks are necessary.

1.1 ACCEPTANCE INSPECTION AND SERVO MOTOR STORAGE

Upon taking delivery of a servo motor, check the following points:

- Is the motor of the correct specification?
(model, shaft, detector, etc.)
- Has the motor been damaged in transit?
- Can the shaft be rotated normally by hand?
- Does the brake operate normally?
- As all the screws securely tightened?

Usually, store the motor indoors, in a location where the temperature falls within the range of -20°C to $+60^{\circ}\text{C}$.

Avoid storing the motor in the following locations:

- Location where the temperature is very high or where condensation is likely
- Location where the temperature varies widely
- Location subjected to constant vibration
(Vibration may damage the bearings.)
- Location subject to much dust

FANUC servo motors are rigorously tested before delivery and do not normally require an acceptance inspection.

1.2 ROUTINE CHECK OF SERVO MOTOR

Make the following checks before starting operation, or once a week or month.

- (1) Vibration or abnormal noise
Check the servo motor for abnormal vibration or noise in the following statuses:

- While stopped
- During low-speed operation
- During acceleration or deceleration

If any abnormal vibration or sound is detected, contact a FANUC service station.

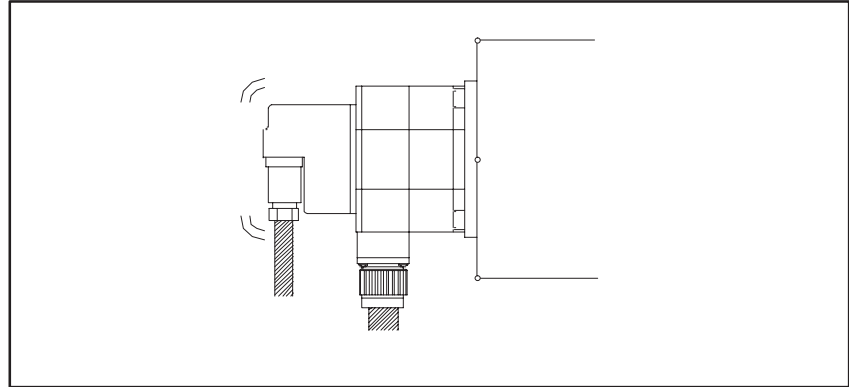

- (2) External damage

Check the motor cover (red plastic cover) for cracks and the motor surface (black-coated) for any abnormalities.

If any cracks are found, perform repair immediately. Alternatively, replace the motor. If you have any questions about the replacement, contact a FANUC service station.

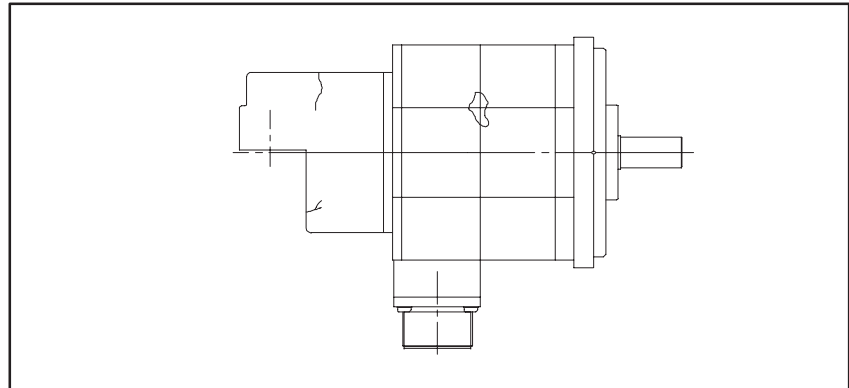

- (3) Dirt

Check the motor surface, screw indentations, and other places for oil or coolant build-up.

Oil or coolant fouling on the surface causes a chemical reaction that affects the coating, ultimately resulting in failure. Wipe away the oil and coolant regularly.

If extensive fouling is noted, determine how the oil or coolant is reaching the motor. Take appropriate action to protect the motor from the oil or coolant. For example, fit a cover.

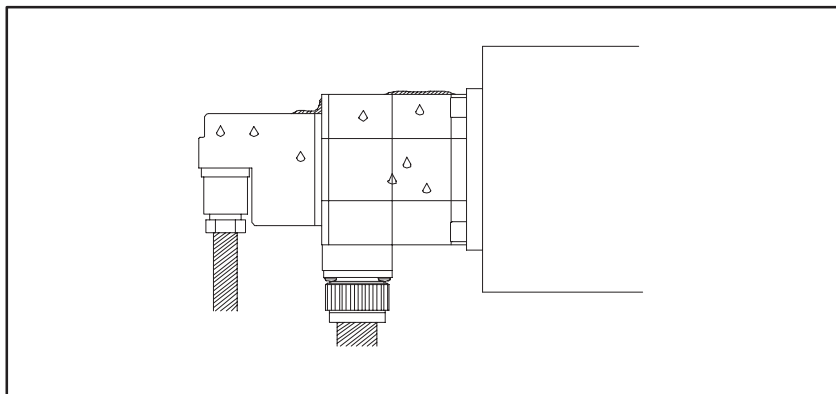

- (4) **Insulation resistance check**
 Measure the insulation resistance between the motor winding and motor frame, using a megohmmeter (500 VDC). Determine whether the insulation resistance is satisfactory according to the standards listed below:

Insulation resistance	Judgment
100M Ω or higher	The insulation is satisfactory.
10 to 100M Ω	The insulation has started to degrade. The degradation has not yet adversely affected the performance. Before starting operation, however, always check the insulation for further degradation. Alternatively, replace the motor.
1 to 10M Ω	The insulation has degraded substantially. Extreme care is necessary. Before starting the operation, always check the insulation for further degradation. Alternatively, replace the motor.
Up to 1 M Ω	The insulation is unacceptable. Replace the motor.

- (5) **Observation of torque command (TCMD) waveform and velocity command (VCMD) waveform**
 Using an oscilloscope, display a normal voltage waveform. Compare the normal waveform with that observed at the periodic check.
 The waveform varies with the load, feedrate, and other conditions. Compare the waveforms observed under identical conditions (rapid traverse at a reference position return, low-speed feed, for example). For details of the observation, see Appendix E, "Servo Check Board."
- (6) **Heat check**
 Check whether the motor has overheated during operation. Check the temperature of the motor surface by using a thermolabel or some other means.

WARNING

The motor surface may reach temperatures as high as 80°C under some operating conditions. Do not touch the motor.

1.3 PERIODIC CHECK OF SERVO MOTOR

Make the following checks about once a year.

- (1) Observation of torque command (TCMD) waveform and velocity command (VCMD) waveform

Using an oscilloscope, display a normal voltage waveform. Compare the normal waveform with that observed at a periodic check.

The waveform varies with the load, feedrate, and other conditions. Compare the waveforms observed under identical conditions (rapid traverse at reference position return, low-speed feed, for example).

For details of the observation, see Appendix E, "Servo Check Board."

- (2) Waveform diagnosis

Check the observed waveform for the following points:

1. Check whether the peak current at rapid traverse acceleration/deceleration exceeds the rating of the amplifier.
If the peak current exceeds the normal value, the load conditions of the machine may have been changed, or the motor may be defective.

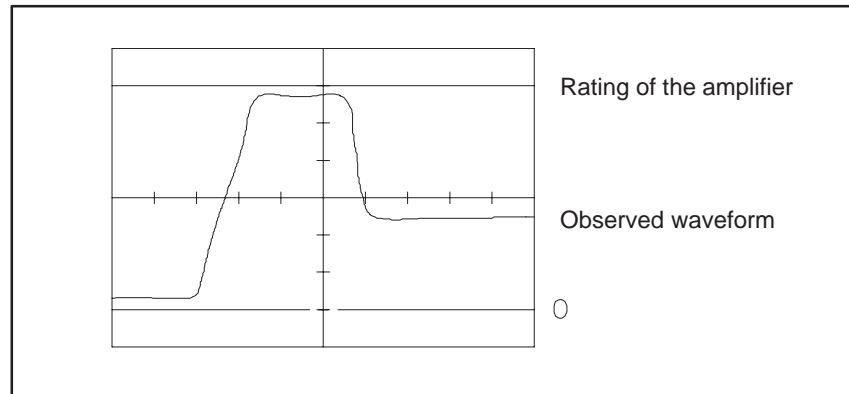

A change in the load conditions of the mechanical system may be caused by the following:

- The internal friction of the machine has changed over time.
- The machine efficiency has been degraded, requiring more power.

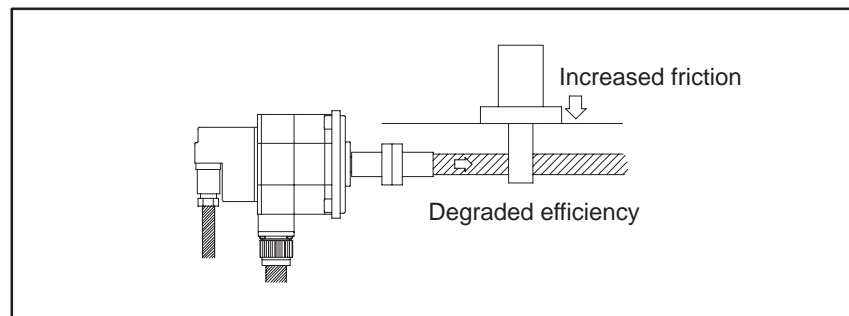

The amplifier ratings are as follows:

β 0.5/3000, β 1/3000, β 2/3000, α 1/3000, α 2/2000, α 2/3000	12A _{peak}
β 3/3000, β 6/2000, α C3/2000, α C6/2000, α C12/2000	20A _{peak}

2. Check whether the waveform is distorted during constant-speed feed.

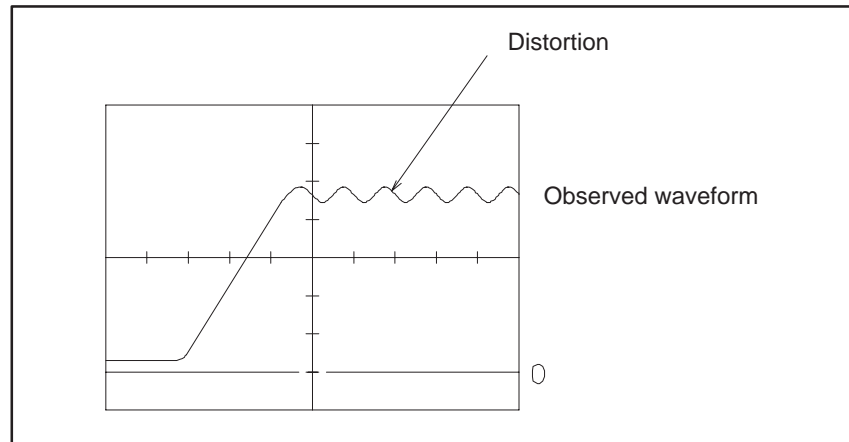

3. Check whether the current waveform is distorted in the stop state.

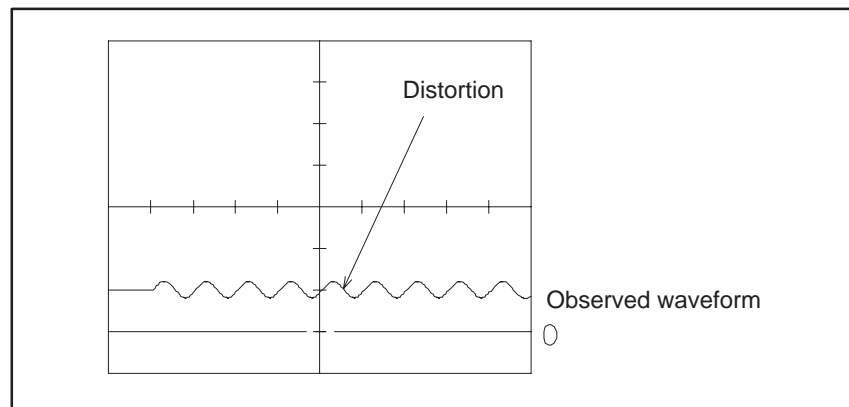

If any abnormality is found when 1, 2, or 3 is checked, contact a FANUC service station.

1.4 ORDER CODES OF REPLACEMENT COMPONENTS

The order codes for maintenance parts are listed below:

(1) Oil seal (NOK Corporation)

Motor model	Oil seal code (manufacturer code)
β 0.5/3000	A98L-0001-0135/C0514E5 (AC0514E5 SC type)
β 1/3000 β 2/300 α 1/3000 α 2/2000 α 2/3000	A98L-0001-0135/C0616E2 (AC0616E2 SC type)
β 3/3000 β 6/2000 α C3/2000 α C6/2000	A98L-0004-0249/A1188RX (BC3554E1)
α C12/2000	A98L-0004-0249/A1189RX(BC3555E1)

APPENDIXES

A SERVO AMPLIFIER UNIT FRONT VIEW

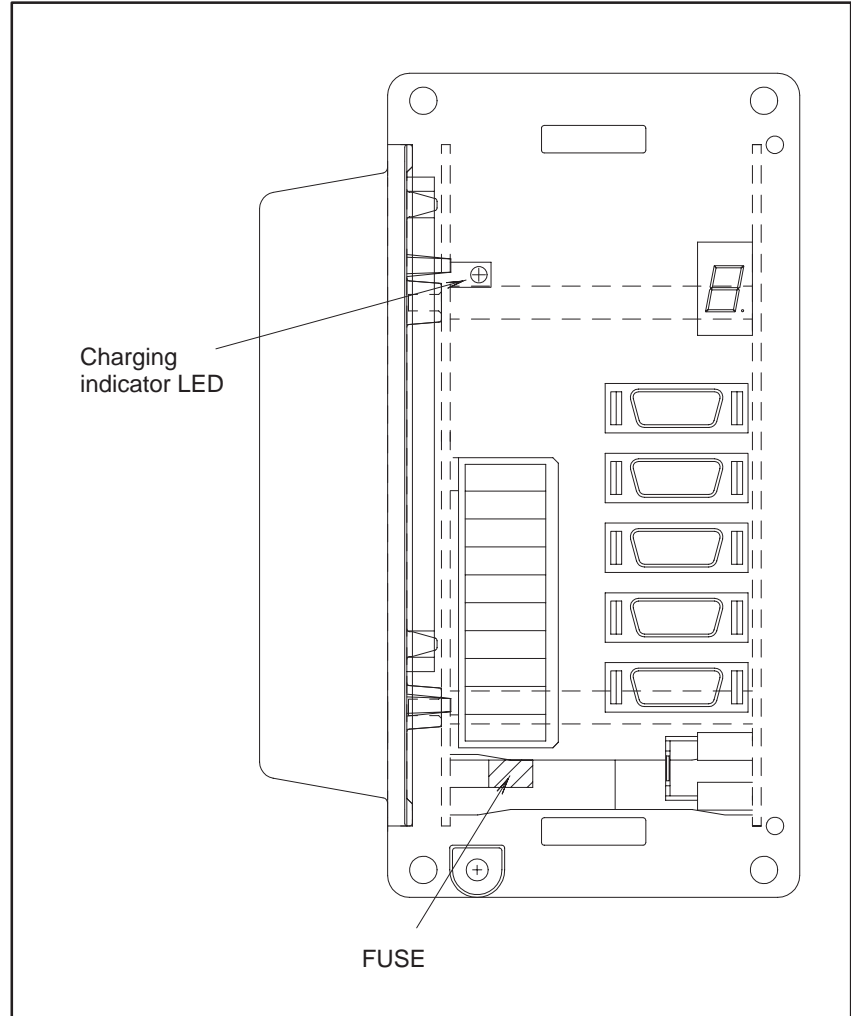

B PARAMETERS

1. Controlled-axis parameters (data No. 000)
2. Coordinate system and stroke limit parameters
(data Nos. 001, 068, 140 to 147, 154 to 165, 170)
3. Feedrate parameters (data Nos. 021, 040 to 050, 054, 061)
4. Acceleration/deceleration control parameters
(data Nos. 002, 055 to 060)
5. Input/output signal parameters
(data Nos. 003, 004, 020, 022, 062, 063, 148 to 152, 166 to 169)
6. Servo parameters
(data Nos. 010 to 014, 016, 030 to 032, 070 to 092, 100 to 111, 180 to 182)

CAUTION

Do not change any parameters during operation.

B.1 CONTROLLED-AXIS PARAMETERS

	#7	#6	#5	#4	#3	#2	#1	#0
000	ROAX	RABX					ROTX	

Size : 1 byte (bit type)

Standard value : 0

ROTX Specifies whether the controlled axis is a linear or rotation axis, as follows:

0 : Linear axis

1 : Rotation axis

RABX Specifies the absolute command-based rotation direction of the rotation axis for movement within one revolution, as follows:

1 : Direction of the smallest distance to a desired point

0 : Direction determined according to a command-specified sign

CAUTION

This parameter is valid only when ROAX = 1.

ROAX Specifies whether the roll-over function of the rotation axis is valid, as follows:

0 : Invalid

1 : Valid

B.2 COORDINATE SYSTEM AND STROKE LIMIT PARAMETERS

	#7	#6	#5	#4	#3	#2	#1	#0
001	EPEXB	EPEXA			SSL1	HOT	ZRTN	

Size : 1 byte (bit type)

Standard value : 0

ZRTN Specifies whether an alarm is to be issued if a reference position is not set up, as follows:

0 : An alarm is issued.

1 : An alarm is not issued.

HOT Specifies whether the overtravel direct input signals (*+OT and *-OT) are valid, as follows:

0 : Invalid

1 : Valid

SSL1 Specifies whether stored stroke limit 1 is valid, as follows:

0 : Invalid

1 : Valid

EPEXA, EPEXB

Specify the operation that is to occur if the axis movement rate determined according to external pulses exceeds the feedrate upper limit specified in parameter No. 43.

EPEXB	EPEXA	Description
0	0	The feedrate is clamped to the parameter-specified value, and the excessive pulses are treated as accumulated pulses. If the number of accumulated pulses exceeds 99999999, the excessive pulses are discarded.
0	1	Alarm 291 is detected, leading to deceleration and stop.
1	0	The feedrate is clamped to the parameter-specified value, and the excessive pulses are discarded.
1	1	Alarm 291 is detected, leading to deceleration and stop.

068	Number of magazines/turrets
-----	-----------------------------

Size : 2-byte

Range : 1 to 9999

Standard value : 0

Description : Sets up the number of magazines/turrets.

140	Machine coordinate of the reference position
-----	--

Size : 4 bytes

Unit : User-specified unit

Range : 0 to ± 99999999

Standard value : 0

Description : Sets up the machine coordinate for the reference position. When setting of the reference position, either without dogs or externally, is completed, the machine coordinate is preset to the value specified in the parameter.

141	Amount of movement per rotation axis revolution
Size	: 4 bytes
Unit	: User-specified unit
Range	: 0 to 99999999
Standard value	: 0
Description	: Specifies an amount of movement per revolution for the rotation axis. If 0 is specified, the amount of movement is assumed to be 36000.
142	Positive machine coordinate for stored stroke limit 1
143	Negative machine coordinate for stored stroke limit 1
Size	: 4 bytes
Unit	: User-specified unit
Range	: 0 to ± 99999999
Standard value	: 99999999 (positive machine coordinate) and -99999999 (negative machine coordinate)
Description	: Sets up the positive and negative machine coordinates for stored stroke limit 1. Areas outside the specified ranges are forbidden areas.
144	Machine coordinate for the second reference position
145	Machine coordinate for the third reference position
Size	: 4 bytes
Unit	: User-specified unit
Range	: 0 to ± 99999999
Standard value	: 0
Description	: Sets up the machine coordinates for the second and third reference positions.
147	Workpiece coordinate for the reference position
Size	: 4 bytes
Unit	: User-specified unit
Range	: 0 to ± 99999999
Standard value	: 0
Description	: Sets up the workpiece coordinate for the reference position. When setting the reference position, either without dogs or externally, is completed, the workpiece coordinate of the reference position is preset to the value specified in the parameter. This parameter is fixed to 0 for the rotation axis.

154	Position for point number 1
-----	-----------------------------

⋮

⋮

165	Position for point number 12
-----	------------------------------

Size : 4 bytes
Unit : User-specified unit
Range : 0 to ± 99999999
Standard value : 0
Description : Specify positions for point numbers 1 to 12 for point positioning.

170	Index point tolerance
-----	-----------------------

Size : 4 bytes
Unit : User-specified unit
Range : 0 to 99999999
Standard value : 0
Description : If the machine deviates from the index point during clamping/unclamping, the index point is preserved, as long as the absolute value for the movement amount is within the value specified in this parameter.

B.3 FEEDRATE PARAMETERS

021	Feedrate command weight N
Size	: 1 byte
Unit	:
Range	: 0 to 8
Standard value	: 3
Description	: Sets up a weight for feedrate parameter Nos. 40, 41, 43 to 50, 54, 59 to 61. Supposing 3 is specified, the feedrate is assumed to be a parameter-specified feedrate multiplied by 10^3 (= 1000).
040	Rapid traverse rate
Size	: 2 bytes
Unit	: 10^N user-specified unit/MIN
Range	: 1 to 65535 (7500 user-specified units/MIN or greater)
Standard value	: 4000
Description	: Specifies a rapid traverse rate. (N is specified in parameter No. 21.)
041	og feedrate
Size	: 2 bytes
Unit	: 10^N user-specified units/MIN
Range	: 1 to 65535 (4 user-specified units/MIN or greater)
Standard value	: 2000
Description	: Specifies the feedrate for job feed when the feedrate override value is 100%. (N is specified in parameter No. 21.)
043	Feedrate upper limit
Size	: 2 bytes
Unit	: 10^N user-specified units/MIN
Range	: 1 to 65535
Standard value	: 4000
Description	: Specifies the upper limit for the feedrate to be specified. If an attempt is made to specify a value larger than the upper limit, the actual feedrate is clamped to the upper limit. (N is specified in parameter No. 21.)

044	Feedrate specified for feedrate code 1
045	Feedrate specified for feedrate code 2
046	Feedrate specified for feedrate code 3
047	Feedrate specified for feedrate code 4
048	Feedrate specified for feedrate code 5
049	Feedrate specified for feedrate code 6
050	Feedrate specified for feedrate code 7

Size : 2 bytes
Unit : 10^N user-specified units/MIN
Range : 1 to 65535 (4 user-specified units/MIN or greater)
Standard value : 2000
Description : Specify the feedrates corresponding to feedrate codes 1 to 7 for command data 1 for a function code command. (N is specified in parameter No. 21.)

054	FL rate for a reference position return
-----	---

Size : 2 bytes
Unit : 10^N user-specified units/MIN
Range : 1 to 65535 (7500 user-specified units/MIN or greater)
Standard value : 100
Description : Specifies a rate of movement to the next grid point during setting of the reference position without dogs. (N is specified in parameter No. 21.)

061	F0 rate for rapid traverse override
-----	-------------------------------------

Size : 2 bytes
Unit : 10^N user-specified units/MIN
Range : 1 to 65535 (7500 user-specified units/MIN or greater)
Standard value : 10
Description : Specifies the F0 rate for rapid traverse override. (N is specified in parameter No. 21.)

B.4 ACCELERATION/ DECELERATION CONTROL PARAMETERS

	#7	#6	#5	#4	#3	#2	#1	#0
002							JOGE	RPDE

Size : 1 byte (bit type)

Standard value : 0

RPDE Specifies the acceleration/deceleration type for rapid traverse, as follows:

0 : Linear or bell-shaped acceleration/deceleration

NOTE) Bell-shaped acceleration/deceleration is selected if rapid traverse bell-shaped acceleration/deceleration time constant T2 is specified.

1 : Exponential acceleration/deceleration

JOGE Specifies the acceleration/deceleration type for jog or cutting feed, as follows:

0 : Linear or bell-shaped acceleration/deceleration

NOTE) Bell-shaped acceleration/deceleration is selected if jog or cutting feed rapid traverse bell-shaped acceleration/deceleration time constant T2 is specified.

1 : Exponential acceleration/deceleration

055	Rapid traverse linear acceleration/deceleration time constant or rapid traverse bell-shaped acceleration/deceleration time constant T1
	Rapid traverse exponential acceleration/deceleration time constant

Size : 2 bytes

Unit : ms

Range : 0 to 4000

Standard value : 100

Description : Specifies a rapid traverse acceleration/deceleration time constant. The acceleration/deceleration time constant to be used is determined depending on whether bit 0 of parameter No. 002 (RPDE) and rapid traverse bell-shaped acceleration/deceleration time constant T2 are set.

056	Rapid traverse bell-shaped acceleration/deceleration time constant T2
-----	---

Size : 2 bytes

Unit : ms

Range : 0 to 512

Standard value : 100

Description : Specifies rapid traverse bell-shaped acceleration/deceleration time constant T2.

057	Linear acceleration/deceleration time constant or bell-shaped acceleration/deceleration time constant T1 for jog feed or feed based on feedrate codes 1 to 7
	Exponential acceleration/deceleration time constant for jog feed or feed based on feedrate codes 1 to 7

Size : 2 bytes
Unit : ms
Range : 0 to 4000
Standard value : 100
Description : Specifies an acceleration/deceleration time constant for jog feed or feed based on feedrate codes 1 to 7. The acceleration/deceleration time constant to be used is determined depending on whether bit 1 of parameter No. 002 (JOG) and bell-shaped acceleration/deceleration time constant T2 for jog feed or feed based on feedrate codes 1 to 7 are set.

058	Bell-shaped acceleration/deceleration time constant T2 for jog feed or feed based on feedrate codes 1 to 7
-----	--

Size : 2 bytes
Unit : ms
Range : 0 to 512
Standard value : 100
Description : Specifies bell-shaped acceleration/deceleration time constant T2 for jog feed or feed based on feedrate codes 1 to 7.

059	Exponential acceleration/deceleration FL rate for jog feed or feed based on feedrate codes 1 to 7
-----	---

Size : 2 bytes
Unit : 10^N user-specified units/MIN
Range : 1 to 65535 (7500 user-specified units/MIN or greater)
Standard value : 10
Description : Specifies the exponential acceleration/deceleration time constant FL rate for jog feed or feed based on feedrate codes 1 to 7. (N is specified in parameter No. 21.)

060	FL rate for rapid traverse exponential acceleration/deceleration
-----	--

Size : 2 bytes
Unit : 10^N user-specified units/MIN
Range : 1 to 65535 (7500 user-specified units/MIN or greater)
Standard value : 10
Description : Specifies the FL rate for rapid traverse exponential acceleration/deceleration. (N is specified in parameter No. 21.)

B.5 INPUT/OUTPUT SIGNALS PARAMETERS

	#7	#6	#5	#4	#3	#2	#1	#0
003	STON	EXPLS	WAT2			IGCP	NCLP	

Size : 1 byte (bit type)

Standard value : 1 only for NCLP

NCLP Specifies whether to use clamping/unclamping, as follows:

0 : Clamping/unclamping is used.

1 : Clamping/unclamping is not used.

IGCP Specifies whether to check a clamp/unclamp state (UCPS2) before proceeding to the next sequence, as follows:

0 : A clamp/unclamp state is checked.

1 : A clamp/unclamp state is not checked.

WAT2 Indicates whether an ID code can be specified for a wait function, as follows:

0 : An ID code cannot be specified.

1 : An ID code can be specified.

EXPLS Indicates whether an axis movement function based on external pulses (pulses from a manual pulse generator) is valid, as follows:

0 : Invalid.

1 : Valid.

STON Specifies whether an automatic operation is started at the rising (off to on) or falling (on to off) edge of the automatic operation start (ST) signal, as follows:

0 : Falling edge (on to off)

1 : Rising edge (off to on)

	#7	#6	#5	#4	#3	#2	#1	#0
004							I VO	SAK

Size : 1 byte (bit type)

Standard value : 0

SAK When the VRDY OFF alarm ignore signal (IGNVRY) is 1 :

0 : Servo ready signal (SA) is set to 0.

1 : Servo ready signal (SA) remains set to 0.

I VO When an attempt is made to release an emergency stop while the VRDY OFF alarm ignore signal (IGNVRY) is 1 :

0 : The emergency stop is not released.

1 : The emergency stop is released.

CAUTION

When the VRDY OFF alarm ignore signal is 1, and the motor is deenergized, a reset state will be exited even if a reset signal is input.

020	Response data specification (PHOUT)
Size	: 1 byte
Standard value	: 3
PHOUT	Specifies whether or what to output as response data 1 (X3 to X6), as follows: 0 : Nothing is output. 1 : An ATC and point No. are output if an ATC cycle and point positioning are involved. 2 : The machine coordinate is output in real time. 3 : The workpiece coordinate is output in real time.
022	ECF and EBSY signal minimum output time
Size	: 1 byte
Unit	: 8 ms
Range	: 0 to 127
Standard value	: 5
Description	: Specifies the minimum output time for the ECF and EBSY signals (direct command interface control flag 2). This is valid when the power motion manager is used.
062	External pulse input-based axis movement amount ratio setting 1 (M)
063	External pulse input-based axis movement amount ratio setting 2 (N)
Size	: 2 bytes
Unit	: 8 ms
Range	: 1 to 32767
Standard value	: 1
Description	: Specify a ratio M/N for an axis movement amount based on an external pulse input.
148	Servo positional deviation monitor amount
Size	: 4 bytes
Unit	: User-specified unit
Range	: 0 to 99999999
Standard value	: 99999999
Description	: Specifies the servo positional deviation monitor amount. The SVERX signal becomes 1 when the servo positional deviation amount becomes larger than the value specified in this parameter.
149	Remaining travel limit for outputting the remaining travel in-range signal (DEN2)
Size	: 4 bytes
Unit	: User-specified unit
Range	: 0 to 99999999
Standard value	: 0
Description	: Specifies the absolute value of a remaining travel value used as a limit to output the remaining travel in-range signal (DEN2).

150	Coordinates (minimum) for point 1 in the operation range of the area signals
-----	--

151	Coordinates for point 2 in the operation range of the area signals
-----	--

152	Coordinates for point 3 in the operation range of the area signals
-----	--

Size : 4 bytes

Unit : User-specified unit

Range : 0 to ± 99999999

Standard value : 0

Description : Specify the points for the output range of the area signals using machine coordinates. Area signals PSG1 and PSG2 are output according to the result of comparison between the machine coordinate and a parameter-specified value. The output conditions are listed below. ABSMT represents the current machine coordinate.

Condition	PSG2	PSG1
ABSMT < point 1	0	0
Point 1 \leq ABSMT < point 2	0	1
Point 2 \leq ABSMT < point 3	1	0
Point 3 \leq ABSMT	1	1

166	Operation completion signal output time
-----	---

Size : 4 bytes

Unit : 8 ms

Range : 0 to 99999999

Standard value : 5

Description : Specifies the output time for operation completion signals OPC1 to OPC4.

167	Time between servo-on and unclamping
-----	--------------------------------------

Size : 4 bytes

Unit : 8 ms

Range : 0 to 99999999

Standard value : 0

Description : Specifies a time interval from the time the servo system is switched on until the machine is unclamped if clamping/unclamping is used.

168	Time between clamping and servo-off
-----	-------------------------------------

Size : 4 bytes

Unit : 8 ms

Range : 0 to 99999999

Standard value : 0

Description : Specifies a time interval from the time the machine is clamped until the servo system is switched off if clamping/unclamping is used.

169	Time allowed before the next sequence is executed without clamping/unclamping
Size	: 4 bytes
Unit	: 8 ms
Range	: 0 to 99999999
Standard value	: 0
Description	: Specifies a time interval from the time the clamp/unclamp command (UCPC2) is issued until the next sequence is started, if the clamp/unclamp state signal (UCPS2) is not to be checked. Whether to check the clamp/unclamp state signal (UCPS2) is specified using bit 2 of parameter No. 003 (IGCP).

B.6 SERVO PARAMETERS

	#7	#6	#5	#4	#3	#2	#1	#0
010	SVFP		ZMIX			IEBL	IALM	IINP

Size	: 1 byte (bit type)
SVFP	Specifies whether to perform follow-up, as follows: 0 : Follow-up is not performed. 1 : Follow-up is performed.
ZMIX	Specifies the initial direction of backlash and grid movement in a reference position return without dogs, as follows: 0 : Positive direction 1 : Negative direction
IEBL	Specifies whether to enable the torque limit function, as follows: 0 : Disable 1 : Enable
IALM	Specifies whether to check for a stop- and movement-time excessive error when the torque is limited, as follows: 0 : An error check is not made. 1 : An error check is made.

NOTE

This parameter is valid, when parameter No.108 is not 0 and IEBL = 1.

IINP	Specifies whether to make a position check when the torque is limited, as follows: 0 : A position check is not made. 1 : A position check is made.
-------------	--

NOTE

This parameter is valid, when parameter No.108 is not 0 and IEBL = 1.

	#7	#6	#5	#4	#3	#2	#1	#0
011	APCX						SZRN	ABSX

Size : 1 byte (bit type)

APCX Indicates whether a detector for an absolute pulse coder is available.
 0 : Unavailable
 1 : Available

SZRN Specifies the type of positioning to a grid to be performed for a manual reference position return if the feed axis and direction selection signal (+X, -X, or I/O link signal from the host) is 1 for reference position return without dogs, as follows:
 0 : Positioning to a grid is performed only once.
 1 : Positioning to a grid is performed each time the feed axis and direction selection signal becomes 1.

ABSX Indicates whether the absolute position detector has been associated with the machine position, as follows:
 0 : Has not been associated
 1 : Has been associated

	#7	#6	#5	#4	#3	#2	#1	#0
012							DGPR	

Size : 1 byte (bit type)

DGPR Specifies whether to set motor-specific servo parameters when the power is switched on.
 0 : Set.
 1 : Do not set.
 After a motor type (parameter No. 30) is specified, resetting this bit to 0 automatically sets up the standard values for the motor when the power is turned on. At the same time, the bit is set to 1 again.

	#7	#6	#5	#4	#3	#2	#1	#0
013			TSA2	TSA1			VCM2	VCM1

Size : 1 byte (bit type)

When bit 0 of parameter No. 14 is 1, the following signals are output to the servo check board.

- Channel 1: VCMD (velocity command)
- Channel 2: TCMD (torque command)
- Channel 3: TSA (actual speed)

These parameters determine the scale of data on channels 1 and 5, as listed below:

VCM2	VCM1	CH1
0	0	VCMD is shifted 3 bits to the right before being output (5 V corresponds to 3750 rpm).
0	1	VCMD is shifted 1 bit to the left before being output (5 V corresponds to 234 rpm).
1	0	VCMD is shifted 5 bits to the left before being output (5 V corresponds to 14.6 rpm).
1	1	VCMD is shifted 9 bits to the left before being output (5 V corresponds to 0.92 rpm).

TSA2	TSA1	CH5
0	0	TSA is shifted 3 bits to the right before being output (5 V corresponds to 3750 rpm).
0	1	TSA is shifted 1 bit to the left before being output (5 V corresponds to 234 rpm).
1	0	TSA is shifted 5 bits to the left before being output (5 V corresponds to 14.6 rpm).
1	1	TSA is shifted 9 bits to the left before being output (5 V corresponds to 0.92 rpm).

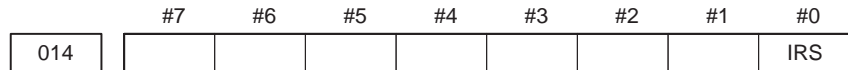

Size : 1 byte (bit type)
IRS Setting this bit to 1 causes the following current to flow in check board channels 1 and 2.
 Channel 1:
 R-phase actual current
 (4 V corresponds the maximum current.)
 Channel 2:
 S-phase actual current
 (4 V corresponds the maximum current.)



Size : 1 byte (bit type)
PIIP 0 : Specifies that the velocity loop be subject to PI control.
 1 : Specifies that the velocity loop be subject to IP control.
LVMD 0 : Disables the low-velocity integration function.
 1 : Enables the low-velocity integration function.
FFVL, FFAL Specify whether to enable the feed-forward function.

FFVL	FFAL	Description
0	X	The feed-forward function is disabled regardless of whether FFAL is 1.
1	1	The feed-forward function is always enabled.
1	0	The feed-forward function may be enabled as directed by the NC.

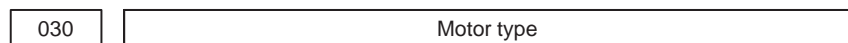

Size : 1 byte
Valid data range : 1 to 89
 This parameter enables the host to specify the type number of a motor to be used.
 The following table lists the types and numbers of motors that can be used with the β series amplifiers, the related ordering code, and amplifier types.

Model	Ordering code	Motor number	Amplifier
β 0.5	0113	13	12A
β 1	0031	35	12A
β 2	0032	36	12A
β 3	0033	33	20A
β 6	0034	34	20A
α 1/3	0310	61	12A
α 2/2	0312	46	12A
α 2/3	0309	62	12A
α c3	0121	7	20A
α c6	0126	8	20A
α c12	0141	9	20A

031	Direction of motor rotation (DIRCTL)
-----	--------------------------------------

Size : 1 byte

Standard setting : 111

The direction of motor rotation is specified, as follows:

- 111: Normal connection
(clockwise rotation as viewed from the detector side)
- 111: Reverse connection
(counterclockwise rotation as viewed from the detector side)

032	Command multiplier (CMR)
-----	--------------------------

Size : 1 byte

Valid data range : 2 to 96 and 102 to 127

Standard setting : 2

This parameter is used to set up a ratio of the command increment to the detection increment.

Let K be the command increment divided by the detection increment, then enter:

$$\text{CMR} = 2 \times K \text{ if } K \geq 1$$

$$\text{CMR} = 1/K + 100 \text{ if } K < 1$$

where K is a value from 1 to 48 or from 1/2 to 1/27.

Example 1) If the least command increment is 10 μm , and the detection increment is 5 μm :

$$\text{CMR} = 10/5 \times 2 = 4$$

Example 2) If the least command increment is 10 μm , and the detection increment is 20 μm :

$$\text{CMR} = 1/(1/2) + 100 = 102$$

$$\text{because } K = 10/20 < 1$$

070	Current loop gain (PK1)
-----	-------------------------

Size : 2 bytes

Valid data range : 1 to 32767

Do not change the standard setting.

071	Current loop gain (PK2)
-----	-------------------------

Size : 2 bytes

Valid data range : -1 to -32768

Do not change the standard setting.

072	Current loop gain (PK3)
-----	-------------------------

Size : 2 bytes

Valid data range : -1 to -32768

Do not change the standard setting.

073	Speed loop gain (PK1V)
-----	------------------------

Size : 2 bytes

Valid data range : 1 to 32767

074	Speed loop gain (PK2V)
-----	------------------------

Size : 2 bytes

Valid data range : -1 to -32768

075	Speed loop gain (PK4V)
-----	------------------------

Valid data range : -1 to -32768

Do not change the standard setting.

078	Current compensation 1 (PVPA)
-----	-------------------------------

Size : 2 bytes

Valid data range : -1 to -32768

Do not change the standard setting.

079	Current compensation 2 (PALPH)
-----	--------------------------------

Size : 2 bytes

Valid data range : -1 to -32768

Do not change the standard setting.

080	Current limit value (TQLIM)
-----	-----------------------------

Size : 2 bytes

Valid data range : 0 to 7282

Do not change the standard setting.

081	Overload protection coefficient (POVC1)
-----	---

Size : 2 bytes

Valid data range : 0 to 32767

This is a coefficient for an alarm used to protect the motor and servo amplifier from overload.

Do not change the standard setting.

082	Overload protection coefficient (POVC2)
-----	---

Size : 2 bytes

Valid data range : 0 to 32767

This is a coefficient for an alarm used to protect the motor and servo amplifier from overload.

Do not change the standard setting.

083	Overload protection coefficient (POVCLM)
-----	--

Size : 2 bytes

Valid data range : 0 to 32767

This is a coefficient for an alarm used to protect the motor and servo amplifier from overload.

Do not change the standard setting.

084	Current compensation 3 (AALPH)
-----	--------------------------------

Size : 2 bytes

Valid data range : 0 to 32767

Do not change the standard setting.

085	Actual current limit (DBLIM)
-----	------------------------------

Size : 2 bytes

Valid data range : 0 to 32767

Do not change the standard setting.

086	Current compensation 4 (MGSTCM)
-----	---------------------------------

Size : 2 bytes

Valid data range : 0 to 32767

Do not change the standard setting.

087	Current compensation 5 (DETQLM)
-----	---------------------------------

Size : 2 bytes

Valid data range : 0 to 32767

Do not change the standard setting.

088	Current compensation 6 (NINTCT)
-----	---------------------------------

Size : 2 bytes

Valid data range : 0 to 32767

Do not change the standard setting.

089	Current compensation 7 (MFWKCE)
-----	---------------------------------

Size : 2 bytes

Valid data range : 0 to 32767

Do not change the standard setting.

090	Current compensation 8 (MFWKBL)
-----	---------------------------------

Size : 2 bytes
Valid data range : 0 to 32767

Do not change the standard setting.

091	VCMD polyline speed (P_VCLN)
-----	------------------------------

Size : 2 bytes
Unit : 0.01 rpm
Valid data range : 0 to 32767

Setting the parameter to a positive value enables the VCMD polyline function. If the actual speed of the motor is lower than the speed specified in this parameter, the position loop gain is doubled, thus accelerating positioning.

092	Low-speed integration threshold speed (P_LVIN)
-----	--

Size : 2 bytes
Unit : 0.01 rpm
Valid data range : 0 to 32767

When the low-speed integration function is enabled, if the actual motor speed becomes higher than the speed specified in this parameter, the speed loop integration item becomes 0.

100	Load inertia ratio (LDINT)
-----	----------------------------

Size : 2 bytes
Valid data range : 0 to 1024

This parameter specifies the ratio of the machine load inertia to the motor inertia using a value calculated with the following formula as a guideline:

$$\text{Load inertia ratio} = \frac{\text{Machine load inertia}}{\text{Motor inertia}} \times 256$$

If the value obtained using this formula is greater than 500, the parameter should be set to 500. Setting this value causes speed loop gains PK1V and PK2V to be multiplied by: $1 + \text{LDINT}/256$

Setting the parameter to a larger value makes response to speed commands quicker and servo rigidity higher. If the parameter is set to an excessively large value, the servo system may vibrate, and noise may arise, during machine movement. Usually, the parameter should not be set to more than 500.

If the machine vibrates at a high frequency, the torque command filter parameter (No.102) can be used to solve this.

101	Acceleration feedback (PK2VAUX)
-----	---------------------------------

Size : 2 bytes

This parameter can be used to suppress vibration. If used, it should be set to a value from -10 to -20.

102	Torque command filter (FILTER)
-----	--------------------------------

Size : 2 bytes

Valid data range : 0 to 2500

Standard setting : 0

This parameter can be used to remove the high-frequency noise induced by a torque command. If the machine vibrates at a high frequency, the use of this parameter may suppress the vibration. The following table lists the relationships between the values specified for the parameter and the corresponding cut-off frequencies.

Cut-off frequency (Hz)	Parameter value
200	1166
150	1596
100	2185
80	2478

The lower the cut-off frequency (the larger the parameter-specified value), the stronger the filter effect. Specifying a filter with an excessively strong effect leads to unstable position control.

First, try a 150 Hz filter (set the parameter to 1596). If this does not suppress high-frequency vibration effectively, increase the parameter value by about 200 and note the effect. Repeat this until the desired effect is obtained, but do not exceed 2500.

103	Feed-forward coefficient (FALPH)
-----	----------------------------------

Size : 2 bytes

Unit : %

Valid data range : 0 to 100

Standard setting : 0

This is a feed-forward coefficient parameter. 100 specified in the parameter corresponds to a coefficient of 1 (100%).

104	Velocity feed-forward coefficient (VFFLT)
-----	---

Size : 2 bytes

Unit : %

Valid data range : 0 to 1000

Standard setting : 0

This is a velocity feed-forward coefficient parameter. For a motor with no load, 100 specified in the parameter corresponds a coefficient of 1 (100%). If a load inertia is added, set the parameter to a proportionally larger coefficient.

Example) If the load inertia is doubled:

To set velocity feed-forward to 100%: $100 \times (1 + 2) = 300$

To set velocity feed-forward to 50%: $50 \times (1 + 2) = 150$

105	Numerator for the number of pulses per motor revolution (SDMR1)
-----	---

Size : 2 bytes

Valid data range : 0 to 65535

Standard setting : 10000

This parameter specifies the number of pulses per motor revolution for a detection increment, together with parameter No. 106. To be specific, this parameter is used as a numerator. If 0 is specified for this parameter, 65536 is assumed.

106	Denominator for the number of pulses per motor revolution (SDMR2)
-----	---

Size : 2 bytes

Valid data range : 0 to 65535

Standard setting : 1

This parameter is used as a denominator for the number of pulses per motor revolution detection increment. The number of pulses (after CMR) per motor revolution is represented as:

$$\frac{(\text{No.105})}{(\text{No.106})}$$

If the number of pulses per motor revolution is an integer, set parameter No. 106 to 1.

Example 1) If a detection increment is set to 1 μ in a 10 mm/revolution ball screw machine:

Set parameter No. 105 to 10000, and parameter No. 106 to 1, because the number of pulses per motor revolution is 10 mm/1 μ = 10000.

Example 2) If the detection increment is 0.1° for a motor coupled directly to the rotation axis:

Set parameter No. 105 to 3600, and parameter No. 106 to 1, because the number of pulses per motor revolution is 360° / 0.1° = 3600.

107	Position loop gain (LPGINX)
-----	-----------------------------

Size : 2 bytes

Valid data range : 1 to 32767

Standard setting : 30

This parameter is related to a position loop time constant. The larger the value set for this parameter, the more quickly the NC responds to commands, and the less time is required for positioning. If the parameter is set to an excessively large value, however, hunting (at 5 to 15 Hz) may occur during movement, or overshoot may occur at a stop. Setting parameter No. 100 (load inertia ratio) to a larger value increases the range of the position loop gain values that can be set up.

108	Servo motor torque limit
-----	--------------------------

Size : 2 bytes

Valid data range : 0 to 7282

Standard setting : 0

Applying a torque limit to the servo motor enables positioning in reference to a mechanical stopper. Setting bit 2 of parameter No. 10 (IEBL) validates a torque limit based on this parameter. If 0 is specified for this parameter, 100% (7282) is assumed. Calculate the necessary setting, using:

$$\text{Value in parameter No. 108} = \text{torque limit value [\%]} \times \frac{7282}{100}$$

109	Backlash amount (BKLCMP)
-----	--------------------------

Size : 2 bytes

Valid data range : 0 to 32767

Standard setting : 0

The parameter sets up a backlash amount (detection increment).

110	Positional deviation limit value at a stop
-----	--

Size : 2 bytes

Valid data range : 0 to 32767

Standard setting : 500

This parameter sets a positional deviation limit value used when the motor is at a stop (detection increment). Alarm 410 is raised if the positional deviation limit is exceeded when the motor is at a stop.

111	In-position width
-----	-------------------

Size : 2 bytes

Valid data range : 0 to 32767

Standard setting : 10

If the positional deviation becomes lower than the value specified in this parameter after the related block ends, an in-position signal is returned to the host.

180	Reference counter capacity
-----	----------------------------

Size : 4 bytes

Valid data range : 0 to 99999999

Standard setting : 10000

This parameter specifies a reference counter capacity.

Reference counter capacity = number of pulses per motor revolution (detection increment)

181	Grid shift amount
-----	-------------------

Size : 4 bytes

Valid data range : 0 to ± 99999999

Standard setting : 0

A grid position can be shifted by the amount specified in this parameter so that the reference position can be shifted. The unit of shift is a detection increment. The maximum grid shift amount that can be specified is half or less than the reference counter capacity.

182	Positional deviation limit value during movement
-----	--

Size : 4 bytes

Valid data range : 0 to 99999999

Standard setting : 3333

This parameter specifies a positional deviation limit value used when the motor is rotating. Alarm 411 is raised, if this value is exceeded, leading to deceleration and stop.

B.7 DIGITAL SERVO STANDARD PARAMETER TABLE

Symbol	Motor model	α C3	α C6	α C12	α 1/3	α 2/2	α 2/3	β 0.5	β 1/3	β 2/3	β 3/3	β 6/2
	Motor ordering code	121	126	141	371	372	373	113	31	32	33	34
	Motor type	7	8	9	61	46	62	13	35	36	33	34
	Parameter No.											
PK1	70	1600	1800	3000	390	1170	450	220	359	704	629	990
PK2	71	-5059	-6105	-9750	-1053	-2289	-900	-540	-1129	-2401	-2093	-3544
PK3	72	-2608	-2641	-2687	-2480	-2485	-2503	-2556	-2564	-2596	-2622	-2632
PK1V	73	52	62	122	54	44	62	4	99	60	140	140
PK2V	74	-932	-1113	-2192	-973	-792	-1119	-77	-894	-1084	-2526	-2526
PK4V	75	-8235	-8235	-8235	-8235	-8235	-8235	-8235	-8235	-8235	-8235	-8235
PPMAX	76	21	21	21	21	21	21	21	21	21	21	21
PDDP	77	1849	1849	1849	1849	1849	1849	1849	1849	1849	1849	1849
PVPA	78	-6405	-4630	-3094	2330	1864	2330	2000	2100	-9229	-8208	-5136
PALPH	79	-250	-2500	-4000	57	46	57	77	71	-1820	-2080	-1600
TQLIM	80	7282	7282	7282	7282	7282	7282	7282	7282	7282	7282	7282
POVC1	81	32686	32637	32412	32623	32627	32519	32585	32617	32540	32456	32456
POVC2	82	1030	1636	4446	1811	1766	3112	2288	1884	2850	3897	3897
POVCLMT	83	3056	4858	13245	5377	5245	9256	6797	5594	8474	11600	11600
AALPH	84	16288	20384	8192	1680	0	2940	17384	0	0	0	0
DBLIM	85	15000	15000	15000	0	0	0	15000	0	12000	15000	12000
MGSTCM	86	16	24	16	0	0	0	0	0	3867	0	3382
DETQLM	87	0	5220	0	0	0	0	0	7784	7868	7799	3120
NINTCT	88	2729	3326	4520	0	0	0	0	0	0	0	0
MFWKCE	89	4000	6500	6000	0	0	0	0	0	0	0	0
MFWKBL	90	1048	1047	785	0	0	0	0	0	0	0	0
TRQCST	112	205	326	395	51	104	74	29	51	83	107	215
MDLCST	115	677	567	288	649	797	564	8162	499	491	252	236

C DIAGNOSIS LISTS



Diagnosis is carried out using the diagnosis screen of the power motion manager on the host.

C.1 SIGNALS SENT FROM CNC (HOST) TO SERVO UNIT

C.1.1 Peripheral Equipment Control Interface (DRC = 0)

	#7	#6	#5	#4	#3	#2	#1	#0
000	ST	UCPS2	-X	+X	DSAL	MD4	MD2	MD1
001		IGNVRY	DRC		*ILK	SVFX	*ESP	ERS
002	Function code				Command data 1			
003	Command data 2							
004	Command data 2							
005	Command data 2							
006	Command data 2							
007	RT	DRN	ROV2	ROV1	*OV8	*OV4	*OV2	*OV1

C.1.2 Direct Command Interface (DRC = 1)

	#7	#6	#5	#4	#3	#2	#1	#0
000	ST		-X	+X		MD4	MD2	MD1
001		IGNVRY	DRC	WFN	*ILK	SVFX	*ESP	ERS
002	RT	DRN	ROV2	ROV1	*OV8	*OV4	*OV2	*OV1
003	INPF							
004	EBUF	EOREND						ECNT
005	Direct command (function number)							
006	Direct command (command data 1)							
007	Direct command (command data 2)							
008	Direct command (command data 3)							
009	Direct command (command data 4)							
010	Direct command (command data 5)							
011	Direct command (command data 6)							
012	Direct command (command data 7)							
013	Direct command (command data 8)							
014	Direct command (command data 9)							
015	Direct command (command data 10)							

CAUTION

- 1 DGN numbers 000 to 015 correspond to signal addresses Yy+ 0 to Yy+15, respectively.
- 2 DGN numbers 008 to 015 (signal addresses Yy+8 to Yy+15) are not used for the peripheral equipment control interface.

NOTE

See Section 2.2 of Part II for details of the signals.

C.2 SIGNALS SENT FROM SERVO UNIT TO CNC (HOST)

C.2.1 Peripheral Equipment Control Interface (DRC = 0)

	#7	#6	#5	#4	#3	#2	#1	#0
016	OPC4	OPC3	OPC2	OPC1	INPX	SUPX	IPLX	DEN2
017	OP	SA	STL	UCPC2			DRCO	
018	MA	AL	DSP2	DSP1	DSALO		RST	ZPX
019	Response data							
020	Response data							
021	Response data							
022	Response data							
023		SVERX		PSG2	PSG1	MVX	APBAL	MVDX

C.2.2
Direct Command
Interface (DRC = 1)

	#7	#6	#5	#4	#3	#2	#1	#0
016					INPX	SUPX	IPLX	DEN2
017	OP	SA	STL				DRCO	WAT
018	MA	AL					RST	ZPX
019	INPFO	SVERX		PSG2	PSG1	MVX	APBAL	MVDX
020	EBSY	EOSTB	ECF		USR1	EOPC	DAL	ECONT
021	Direct command (function number)							
022	Reserved				Execution result			
023	Direct command (response data 1)							
024	Direct command (response data 2)							
025	Direct command (response data 3)							
026	Direct command (response data 4)							
027	Direct command (response data 5)							
028	Direct command (response data 6)							
029	Direct command (response data 7)							
030	Direct command (response data 8)							
031	Direct command (response data 9)							

CAUTION

- 1 DGN numbers 016 to 031 correspond to signal addresses Xx+0 to Xx+15, respectively.
- 2 DGN numbers 024 to 031 (signal addresses Xx+8 to Xx+15) in the peripheral equipment control interface are used as response area for the power motion manager.

NOTE

See Section 2.2 of Part II for details of the signals.

C.3**SERVO POSITIONAL
DEVIATION AMOUNT
(SERVO UNIT)**

032

Servo positional deviation amount (servo unit)

C.4**ACCELERATION/
DECELERATION
DELAY AMOUNT
(SERVO UNIT)**

033

Acceleration/deceleration delay amount (servo unit)

D POWER MOTION MANAGER FUNCTIONS



D.1 OVERVIEW

This chapter explains the power motion manager functions used by the CNC to set up and display the types of data for amplifiers with an I/O link.

The functions provided are:

- (1) Current position display (absolute/machine coordinate)
- (2) Parameter display and setting
- (3) Diagnosis
- (4) System configuration screen
- (5) Alarm

NOTE

These functions may not be available depending on the CNC model or option with which they are used.

D.2 I/O LINK CONNECTION

If a β amplifier with an I/O link is used, the CNC assigns I/O addresses for it. Because the CNC exchanges data with an amplifier with an I/O link in 16-byte units, it is necessary to set the number of input/output points to 128. Up to eight β amplifiers with an I/O link can be connected.

The names of modules used for I/O link connection are OC02I (16-byte input) and OC02O (16-byte output). The BASE and SLOT are always 0 and 1, respectively.

D.3 FUNCTION SELECTION AND TERMINATION

D.3.1 Selection

Each power motion manager function can be selected by first pressing the next–menu key (rightmost soft key) on the CNC system screen several times until [PMM] is displayed, then pressing this soft key. The initial screen, that is, the system configuration screen, for the power motion manager appears. On this screen, the desired function can be selected by pressing the corresponding soft key.

After a power motion manager function has been selected, if a function key on the MDI is pressed to select another function, then the SYSTEM function key is pressed, the previous screen of the function appears again. In this case, however, data being input has been canceled.

D.3.2 Function Selection Soft Key

When a power motion manager function is selected, its initial screen, that is, system configuration screen appears, and the following soft key menu is displayed (for a 9–inch CRT).



The soft key for the currently selected screen is displayed in reverse video. The soft keys of this menu are used to select the following functions.

POS : Current position display

SYSTEM: System information

MSG : Alarm list

After one of the above functions is selected, another function can be selected by pressing the previous–menu key (leftmost soft key) several times until this soft key menu appears, then pressing the soft key for the desired function in the menu.

D.3.3 Termination

When the leftmost soft key is pressed to display the function selection keys described in Section D.3.2, then the previous–menu key is pressed, the soft key menu for the CNC system appears, and the power motion manager function is terminated. At this point, the system configuration screen for the power motion manager functions is displayed as the end screen.

After a power motion manager function is selected, another function can be selected by pressing the corresponding function key (POS, PROG, MESSAGE, etc.) on the MDI.

D.3.4 Disabling the Power Motion Manager Functions

Once the data necessary for a connected β amplifier with an I/O link has been set up or confirmed, it is possible to discontinue communication with the power motion manager (PMM) to give priority to those commands sent from the ladder program of the CNC to slaves. This is done by setting bit 3 of parameter P960 to 1. Communication between the CNC and a β amplifier with an I/O link via an I/O link is surrendered to the ladder program.

When this parameter is 1, only communication-independent items, such as a title and function name, are displayed on the screen. The following message appears to indicate that communication has been discontinued.
COMMUNICATION PROHIBITED BY P960#3

D.3.5 Parameter Setting

So that the power motion manager functions can run properly, it is necessary to set the following data on the CNC parameter screen.

Parameter P960

- (1) Bit 0 (SLV) (screen display)
 - 0 : One slave per screen
 - 1 : Four slaves per screen
- (2) Bits 1 and 2 (MD1 and MD2) (data input/output destinations)
 - 00: CNC memory (NOTE)
 - 10: Memory card
- (3) Bit 3 (PMM) (whether to disable the PMM)
 - 0 : Enable
 - 1 : Disable

NOTE

A data file is saved as a program to a memory area. The CNC program list screen displays which memory area is used for a particular data file.

D.3.6 Restriction

When a power motion manager function is used, it is impossible to use an I/O link-based data input/output function.

(2) Status transition diagram for the soft keys designed for use on the 14-inch CRT

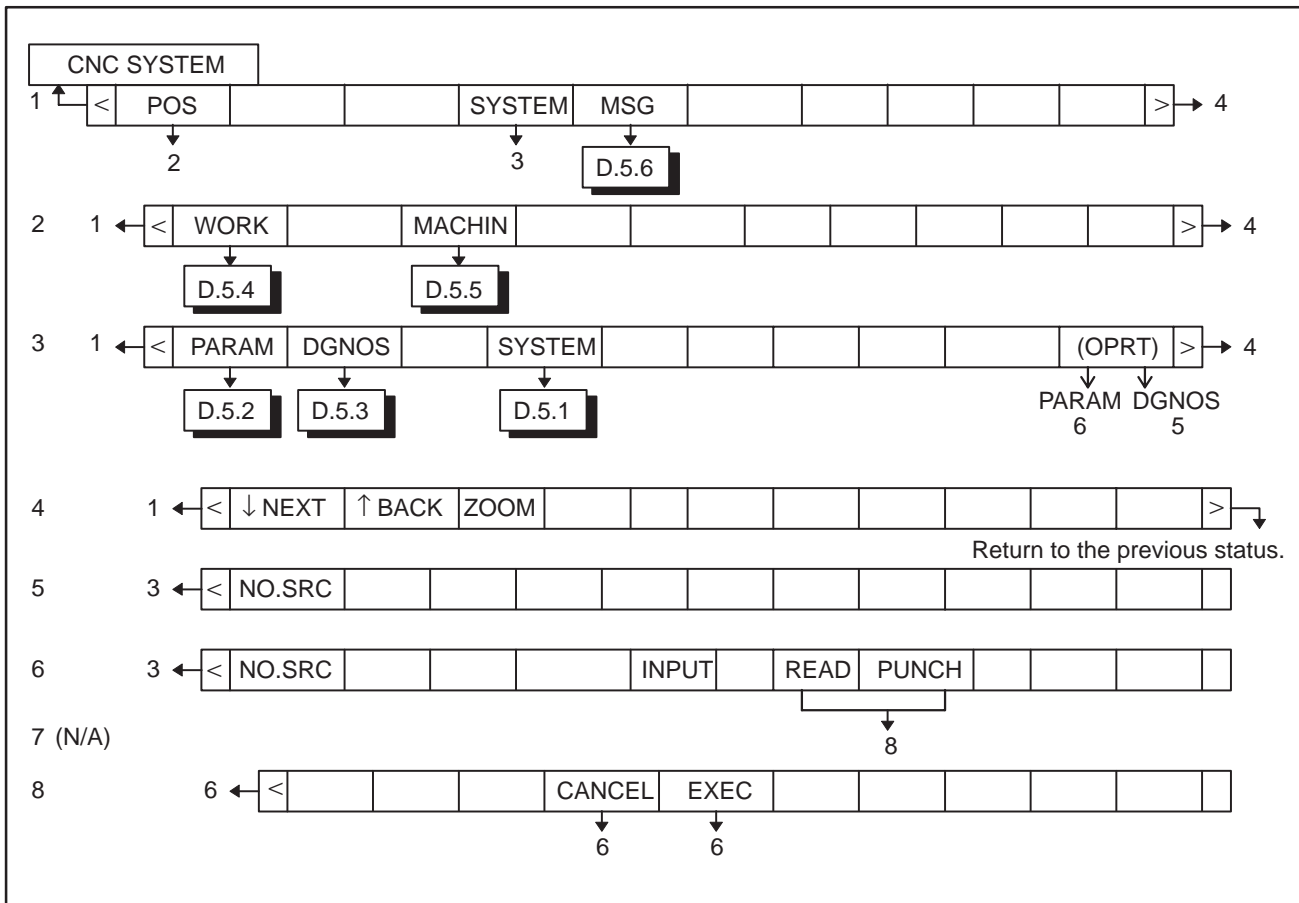

(3) Display screen

If a soft key from 2 to 4 is pressed, the corresponding screen appears. Pressing the previous-menu key resumes the function selection soft key menu. Pressing the previous-menu key again switches the display screen and soft keys to the CNC system screen and terminates the power motion manager function.

D.4.2 Screen Configuration

(1) Selecting an active slave

The term "active slave" refers to the β amplifier with an I/O link that is a target of the zoom and parameter write functions explained in (2). The title of an active slave is displayed in a different color from other β amplifiers with an I/O link. An active slave can be selected using the [\downarrow NEXT] and [\uparrow BACK] soft keys displayed by pressing the next-menu key several times.

[\downarrow NEXT]: Displays the screen for a β amplifier with an I/O link connected ahead of the current amplifier with an I/O link. Equipment other than β amplifiers with an I/O link is ignored.

[\uparrow BACK]: Displays the screen for a β amplifier with an I/O link connected behind the current β amplifier with an I/O link.

(3) Guidance messages

The following table lists the guidance messages that appear on the message line when soft keys are displayed. See Section D.4.1 for details of soft keys 1 to 8.

Soft key	Message
1 to 3	SELECT ACTIVE SLAVE [>]
4	SELECT ACTIVE SLAVE [↓] [↑]
5 to 8	No message is displayed, because these soft keys have the same functions as in the existing CNC software. The message line is used as a key-in line to display the entered data.

(4) Key-in line

After the [(OPRT)] soft key is pressed, the message line becomes the key-in line, as required. The key-in line displays numeric data keyed in, from the MDI keypad, at the prompt >.

On the parameter and diagnosis screens, the key-in line appears when numeric data is keyed in, even if the [(OPRT)] soft key has not been pressed.

(5) Data input/output

Once input/output units have been set up, data input/output is started by first pressing the [READ] or [PUNCH] soft key on the parameter screen, then [EXEC]. Keep in mind that it is impossible to switch to another screen during an input/output operation. The input/output operation is discontinued if an alarm condition is detected during communication.

D.4.3 Operations of an Active Slave

(1) Operations

1. Pressing the [(OPRT)] soft key prepares the required processes, such as data rewrite and data search, for execution.
2. The cursor and page keys on the MDI keypad can be used to move the cursor or display another page for the active slave.
3. To reselect the active slave, use the [↑ BACK] and [↓ NEXT] soft keys. These soft keys are displayed by pressing the previous-menu key to return to the soft key menu that was displayed before [(OPRT)] was pressed, then the next-menu key several times.

(2) Alarms

1. CNC
In an alarm condition occurs in the CNC, the CNC alarm screen appears automatically. Check the alarm message, then press the SYSTEM function key to switch back to the previous function screen, as required.
2. Slave
Usually, a guidance message is displayed on the message line. If an alarm condition occurs in the β amplifier with an I/O link, the group number for the amplifier is displayed at the right end of the line. See the alarm screen for details of the alarm.

(3) Data protection key

If the CNC data protection key is set to the on position, it is impossible to write parameters into the CNC memory.

D.5 FUNCTION DETAILS

D.5.1 System Configuration

The system configuration screen displays system software information about the β amplifiers with an I/O link. This screen is the first screen that appears when a power motion manager function is selected. The system configuration screen also appears when the power motion manager function is terminated.

(1) Display operations

Pressing the [SYSTEM] function selection soft key displays the following soft key menu and the screen that was displayed when SYSTEM was previously selected. The soft key for the currently displayed function is displayed in reverse video.

```
[ PARAM ] [ DGNOS ] [          ] [SYSTEM] [(OPRT)]
```

Pressing the [SYSTEM] soft key again selects and displays the system configuration screen. While this screen is displayed, the [SYSTEM] soft key is displayed in reverse video.

(2) Displays

```
POWER MOTION MANAGER
SYSTEM CONFIGURATION
1. GROUP0 / $\beta$ 
SYSTEM (SERIES/VERSION) 88A1 01
SELECT ACTIVE SLAVE [>]
[PARAM] [DGNOS] [          ] [SYSTEM] [          ]
```

Display example: Servo unit β series system software series and edition

D.5.2 Parameters

The parameters required for each function of the β amplifiers with an I/O link must be set up in advance.

(1) Display operations

Pressing the [SYSTEM] function selection soft key displays the following soft key menu:



Pressing the [PARAM] soft key displays the parameter screen.

(2) Displays

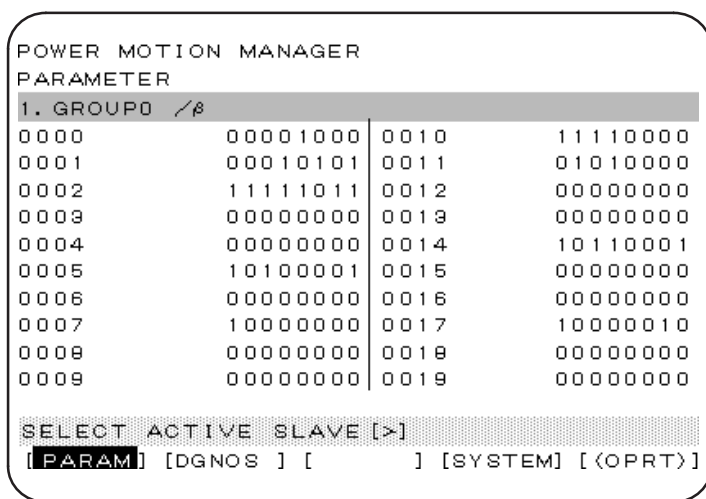

This screen displays bit-type and decimal data only.

(3) Saving parameters

Parameters can be saved as program data files to the CNC memory or to a memory card.

To save parameters, first set the first registration program number in parameter P8760. Programs are created using a number assigned to each β amplifier with an I/O link. This number is treated as a program number when the parameters are saved to the CNC memory. When they are saved to a memory card, however, a file is created using the program number and PMM as its file name and file extension, respectively.

Example: If 8000 is set in parameter P8760

A program number for a program in group n is: $8000 + n \times 10$

The group number is a number in "group n" displayed in the title of a β amplifier with an I/O link. If an existing program in the memory has the same program number, the existing program is overwritten with the new data.

Parameter P960 is used to select a device to save parameters.

See D.3.5 for details.

Before proceeding to the following steps, connect a memory card or ensure that the CNC memory is available.

1. Select an active slave.
2. Press the [[OPRT]] soft key to display:

```

[NO.SRC] [      ] [      ] [      ] [INPUT]

```

Press the next-menu key.

```

[      ] [ READ ] [PUNCH] [      ] [      ]

```

3. Press the [READ] soft key to display:

```

[      ] [      ] [      ] [CANCEL] [ EXEC ]

```

Press the [EXEC] soft key.

While the parameters are being saved, the message "INPUT" blinks on the message line.

(4) Writing parameters

Parameter data files saved as programs to the CNC memory or memory CAD can be restored and written to the β amplifier with an I/O link determined from a program number. The program number and device are determined using the same method as in item (3).

1. Select an active slave.
2. Press the [[OPRT]] soft key to display:

```

[NO.SRC] [      ] [      ] [      ] [INPUT]

```

Press the next-menu key.

```

[      ] [ READ ] [PUNCH] [      ] [      ]

```

3. Press the [PUNCH] soft key to display:

```

[      ] [      ] [      ] [CANCEL] [ EXEC ]

```

Press the [EXEC] soft key.

While the parameters are being written, the message "OUTPUT" blinks on the message line.

(5) Searching for parameters

A parameter can be searched for and displayed by means of the following procedure.

1. Select an active slave.
2. Press the [[OPRT]] soft key to display:

```

[NO.SRC] [      ] [      ] [      ] [INPUT]

```

3. Key in a desired number on the key-in line using the MDI keypad, then press the [NO.SRC] soft key to start the search.

(6) Setting parameters

Parameters for β amplifiers with an I/O link can be set directly from the CNC by means of the following procedure.

1. Select an active slave.
2. Press the [[OPRT]] soft key to display:

```
[NO.SRC] [      ] [      ] [      ] [INPUT]
```

3. Position the cursor to the desired parameter.
4. Key in the desired data on the key-in line using the MDI keypad, then press the [INPUT] soft key or the INPUT key on the MDI keypad.

D.5.3 Diagnosis

The status of the current processing for a β amplifier with an I/O link can be referenced using the diagnosis screen.

(1) Display operations

Pressing the [SYSTEM] function selection soft key displays the following soft key menu:

```
[ PARAM ] [ DGNOS ] [      ] [SYSTEM] [[OPRT]]
```

Pressing the [DGNOS] soft key displays the diagnosis screen.

(2) Displays

Basically, the same screen as that used for parameter handling is used.

D.5.4 Absolute Coordinate

The current position can be displayed using a workpiece coordinate system. The absolute coordinate screen appears when the POS soft key is pressed for the first time after the power is switched on.

(1) Display operations

Pressing the [POS] function selection soft key displays the following soft key menu:

```
[ WORK ] [      ] [MACHIN] [      ] [      ]
```

Pressing the [WORK] soft key displays the absolute coordinate screen.

(2) Displays

```
POWER MOTION MANAGER
POSITION (WORK)
1. GROUP0 / $\beta$ 

1          1 2 6 7 9 0 0
F          3 5 0 0

SELECT ACTIVE SLAVE [>]
[ WORK ] [      ] [MACHIN] [      ] [      ]
```

1 : Coordinate F : Actual speed

D.5.5 Machine Coordinates

The current position can be displayed using a machine coordinate system.

- (1) Display operations
Pressing the [POS] function selection soft key displays the following soft key menu:

```
[ WORK ] [           ] [MACHIN] [           ] [           ]
```

Pressing the [MACHIN] soft key displays the machine coordinate screen.

- (2) Displays
Basically, the same screen as that used for the absolute coordinates is used for the machine coordinates.

D.5.6 Alarms

If an alarm condition occurs in processing for a β amplifier with an I/O link, the group number for the amplifier is displayed at the right end of the message line on each screen. The alarm can be checked on the corresponding alarm screen. Example: "13" (indicating that an alarm condition has occurred in β amplifiers with an I/O link in groups 1 and 3).

- (1) Display operations
Pressing the [MSG] function selection soft key displays only an error code on the screen.
- (2) Displays

```
POWER MOTION MANAGER
ALARM
1. GROUP0 /β
442    210    232

SELECT ACTIVE SLAVE [>]          (0)
[ POS ] [           ] [           ] [SYSTEM] [ MSG ]
```

Up to 40 items can be displayed.

E SERVO CHECK BOARD

(1) Overview

The servo check board converts digital values, used in digital servo control, to an analog voltage so that they can be observed on an oscilloscope.

(2) Servo check board ordering information

Ordering code	Name
A06B-6057-H602	Servo check board (with a reverse-instruction prevention cable)
A06B-6093-K021	Check board adapter (with a cable, dedicated to β amplifiers with an I/O link)

(3) Servo check board connection

Before attempting to connect the servo check board, switch off the NC power. The clock pin (S1) of the check board must always be strapped to the 5 MHz position.

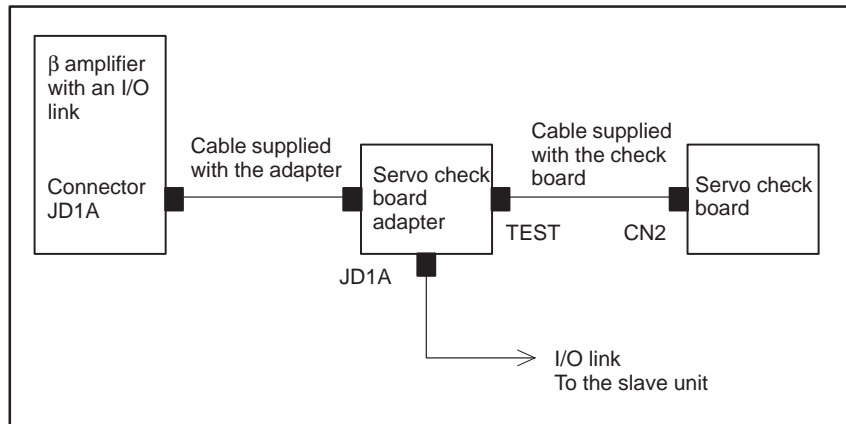

(4) Signal output locations

When bit 0 of parameter No. 14 = 0:

Check pin	CH1	CH2	CH5
Signal name	VCMD	TCMD	TSA

To observe signals on channels 1, 2, and 5, set the rotary switch on the check board to position 0.

When bit 0 of parameter No. 14 = 1:

Check pin	CH1	CH2	CH5
Signal name	R-phase actual current	S-phase actual current	TSA

To observe signals on channels 1, 2, and 5, set the rotary switch on the check board to position 0.

(5) VCMD signal

The VCMD signal is used to output a velocity command. This signal can also be used to measure the minute vibrations of the motor and any uneven feed.

Before observing this signal, check that bit 0 of parameter No. 14 is 0.

The amplitude of the VCMD signal can be switched using bits 0 and 1 of parameter No. 13.

The VCMD signal switches between +5 V and -5 V. Switch the amplitude using this parameter if it is difficult to observe the waveform.

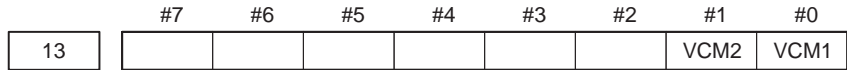

VCM2	VCM1	Number of specified revolutions/5 V
1	1	0.9155 rpm
1	0	14 rpm
0	1	234 rpm
0	0	3750 rpm

First, observe the entire waveform of the signal using the DC mode of the oscilloscope, then switch to AC mode and enlarge the range. Minute vibration and uneven positional shifts can be checked.

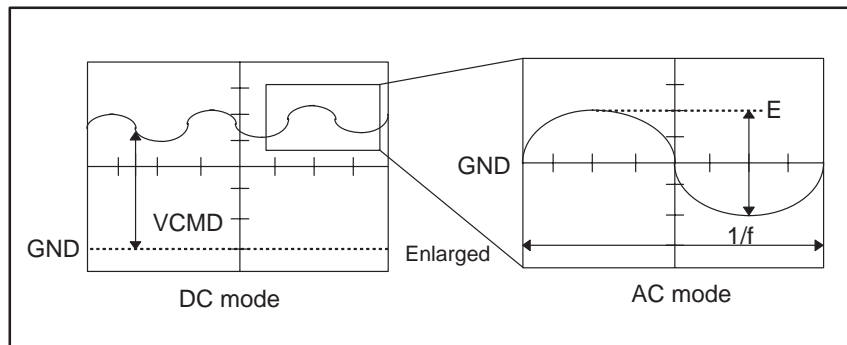

Letting W (rpm/5 V) be the signal conversion ratio of the VCMD waveform, the voltage per positional deviation amount pulse is:

$$\text{Voltage (V) per positional deviation amount pulse} = \frac{300 \times \text{position gain (s}^{-1}\text{)}}{\text{Number of position feedback pulses/motor revolution} \times W}$$

(Example)

Supposing position gain = 30 (s⁻¹), number of position feedback pulses/motor revolution = 10,000, E = 300 mV, 1/f = 20 ms, VCM1 = 0, and VCM2 = 1, the voltage per positional deviation pulse is: 64 mV/pulse

Thus:

Table vibration = 300 × 1/64 = 4.6 μm

Vibration cycle = 50 Hz

(6) TCMD signal

The TCMD signal is used to output a motor torque command. When the motor is rotating at high speed, the current indicated by this signal may differ from the actual motor current (IR or IS) because of the back electromotive force in the motor.

Before observing this signal, check that bit 0 of parameter No. 14 is 0.

Maximum current	Maximum-current signal output	Ap/V	Applicable servo motor
12Ap	4.44V	2.7	β 0.5/3000, β 1/3000 β 2/300, α 1/3000 α 2/2000, α 2/3000
20Ap	4.44V	4.5	β 3/3000, β 6/2000 α C3/2000, α C6/2000 α C12/2000

Effective (RMS) value = TCMD signal output (Ap) x 0.71

(7) TSA signal

The TSA signal is used to output the rotational speed of the motor. The amplitude of the signal can be switched using bits 4 and 5 of parameter No. 13.

The TSA signal switches between +5 V and -5 V. Switch the amplitude using this parameter if it is difficult to observe the waveform.

	#7	#6	#5	#4	#3	#2	#1	#0
13			TSA2	TSA1				

TSA1	TSA2	Number of specified revolutions/5 V
1	1	0.9155 rpm
1	0	14 rpm
0	1	234 rpm
0	0	3750 rpm

(8) IR signal

The IR signal is used to output the R-phase actual current of the motor. Before observing the signal, check that bit 0 of parameter No. 14 is 1.

Maximum current	Maximum-current signal output	Applicable servo motor
12Ap	4V	β 0.5/3000, β 1/3000 β 2/300, α 1/3000 α 2/2000, α 2/3000
20Ap	4V	β 3/3000, β 6/2000 α C3/2000, α C6/2000 α C12/2000

(9) IS signal

The IS signal is used to output the S-phase actual current of the motor.
Before observing the signal, check that bit 0 of parameter No. 14 is 1.

Maximum current	Maximum-current signal output	Applicable servo motor
12Ap	4V	β 0.5/3000, β 1/3000 β 2/300, α 1/3000 α 2/2000, α 2/3000
20Ap	4V	β 3/3000, β 6/2000 α C3/2000, α C6/2000 α C12/2000

[A]

Absolute Coordinate, 173
 Acceleration/Deceleration Control Parameters, 137
 Acceleration/Deceleration Delay Amount (Servo Unit), 160
 Acceptance Inspection and Servo Motor Storage, 120
 Alarm, 35
 Alarm (AL), 77
 Alarm Display and Corresponding Countermeasures, 104
 Alarms, 174
 ATC/Turret Control, 59
 Automatic Operation, 42
 Axis Movement Commands, 91

[B]

Basic Configuration, 5

[C]

Cautions on Using the Power Motion Manager, 25
 Check Procedure, 16
 Checking the Power Supply Voltage and Capacity, 9
 Clamp and Unclamp (for the Peripheral Equipment Control Interface Only), 43
 Command Completion Notification (ECF), 76
 Command Format for Peripheral Equipment Control, 55
 Configuration, 4
 Connection of the Separate Regenerative Discharge Unit, 11
 Control of the Point Data External Setting Function, 71
 Controlled-Axis Parameters, 131
 Coordinate System and Stroke Limit Parameters, 132
 Coordinate System Setting, 69

[D]

Detailed Description, 100
 Details of Direct Command Functions, 79
 Details of Function Codes, 59
 Diagnosis, 173

Diagnosis Lists, 155
 Digital Servo Standard Parameter Table, 154
 Direct Command Control Procedure, 75
 Direct Command Execution Result, 77
 Direct Command Format, 73
 Direct Command Function Code and Related Information, 47
 Direct Command Interface, 24, 29
 Direct Command Interface (DRC = 1), 157, 159
 Direct Commands, 72, 78
 Direct Input Signals, 53
 Disabling the Power Motion Manager Functions, 165
 DO/DO Signals, 27

[E]

External Pulse Input Function, 98

[F]

Feedrate, 40
 Feedrate Parameters, 135
 Function Codes, 57
 Function Details, 170
 Function Overview, 166
 Function Selection and Termination, 164
 Function Selection Soft Key, 164

[I]

I/O Link Connection, 163
 I/O Link Interface Area, 23
 Input/Output Signals Parameters, 139
 Instruction Command Control (EBUF, EBSY, and ECNT), 75
 Interface, 24
 Interface Switching, 24
 Interlock, 41

[J]

Jog Feed, 36

[L]

Leakage Current and Ground Fault Interrupter, 10

[M]

Machine Coordinates, 174
 Maintenance of Servo Motor, 119
 Memory Registration Procedure, 97
 Mode Selection, 36

[O]

Operation Check Method, 15
 Operation Procedure, 97
 Operations of an Active Slave, 169
 Order Codes of Replacement Components, 125

[P]

Parameter Initialization, 12
 Parameter Setting, 165
 Parameters, 80, 130, 171
 Periodic Check of Servo Motor, 123
 Peripheral Equipment Control, 54
 Peripheral Equipment Control Function Code and Related Information, 45
 Peripheral Equipment Control Interface, 24, 27
 Peripheral Equipment Control Interface (DRC = 0), 156, 158
 Peripheral Equipment Control Procedure, 56
 Point Positioning Control, 61
 Positioning Control (Absolute/Incremental Specification), 67
 Power Motion Manager Functions, 161
 Power Supply Connection, 9
 Preparation Completion, 33

[R]

Receiving Response Data, 56
 Reference Position Return, 42, 63

Reference Position Setting (when the Reference Position External Setting Function is Used), 65
 Replacing Battery of the Absolute Pulse Coder, 113
 Replacing Fuse, 109
 Reset and Emergency Stop, 34
 Response Command Control (EOREND, EOSTB, EOPC, USR1, and ECONT), 76
 Restriction, 165
 Routine Check of Servo Motor, 121

[S]

Screen Configuration, 167
 Selection, 164
 Servo Amplifier Unit Front View, 129
 Servo Check Board, 175
 Servo Parameters, 143
 Servo Positional Deviation Amount (Servo Unit), 160
 Servo Unit Interface, 22
 Servo-off, 44
 Signal Descriptions, 26
 Signal Details, 33
 Signal Operation Commands, 79
 Signals (Listed in Groups), 31
 Signals Sent from CNC (Host) to Servo Unit, 156
 Signals Sent from Servo Unit to CNC (Host), 158
 Soft Key Status Transition Diagram, 166
 Specifying Operation Using a Function Code, 56
 Start-up Procedure, 7
 Start-up Procedure (Summary), 8
 Status Read, 82
 Status Signals, 37
 System Configuration, 170

[T]

Teaching-based Data Setting Control, 70
 Termination, 164
 Thirty-Two-Block Buffering Operation, 97

Revision Record

FANUC SERVO MOTOR β series I/O Link Option MAINTENANCE MANUAL (B-65245EN)

Edition	Date	Contents	Edition	Date	Contents
01	Sep., '97	_____			

- *No part of this manual may be reproduced in any form.*
- *All specifications and designs are subject to change without notice.*