

Premium and Atrium using EcoStruxure™ Control Expert Fipway Network User Manual

(Original Document)

12/2018

The information provided in this documentation contains general descriptions and/or technical characteristics of the performance of the products contained herein. This documentation is not intended as a substitute for and is not to be used for determining suitability or reliability of these products for specific user applications. It is the duty of any such user or integrator to perform the appropriate and complete risk analysis, evaluation and testing of the products with respect to the relevant specific application or use thereof. Neither Schneider Electric nor any of its affiliates or subsidiaries shall be responsible or liable for misuse of the information contained herein. If you have any suggestions for improvements or amendments or have found errors in this publication, please notify us.

You agree not to reproduce, other than for your own personal, noncommercial use, all or part of this document on any medium whatsoever without permission of Schneider Electric, given in writing. You also agree not to establish any hypertext links to this document or its content. Schneider Electric does not grant any right or license for the personal and noncommercial use of the document or its content, except for a non-exclusive license to consult it on an "as is" basis, at your own risk. All other rights are reserved.

All pertinent state, regional, and local safety regulations must be observed when installing and using this product. For reasons of safety and to help ensure compliance with documented system data, only the manufacturer should perform repairs to components.

When devices are used for applications with technical safety requirements, the relevant instructions must be followed.

Failure to use Schneider Electric software or approved software with our hardware products may result in injury, harm, or improper operating results.

Failure to observe this information can result in injury or equipment damage.

© 2018 Schneider Electric. All rights reserved.

Table of Contents



	Safety Information	7
	About the Book	11
Part I	Introduction to Fipway communication	13
Chapter 1	Introduction to Fipway communication	15
	Introduction to communication	15
Part II	Hardware implementation for Fipway communication	17
Chapter 2	Introduction to hardware implementation	19
	Devices used for communication functions	20
	Fipway Architecture	21
	Operating standards	22
Chapter 3	Implementation of TSX SCY 21601 module	23
3.1	At a Glance	24
	Introduction	24
3.2	Description	25
	Description	25
3.3	Built-in Channel Specifications	27
	Characteristics of the built-in channel	27
3.4	TSX SCY 21601 Module's Host Channel Compatibility	28
	TSX SCY 21601 Host Channel Compatibility	28
3.5	Installation	29
	Installation	29
3.6	Operation	31
	Operation	31
3.7	Module Visual Diagnostics	32
	Visual diagnostics of the module	32
3.8	Built-in Channel Connection	34
	At a Glance	35
	Power consumption of the TSX SCY 21601 module	36
Chapter 4	Implementation of PCMCIA Cards	37
4.1	At a Glance	38
	Introduction	38
4.2	Description	40
	Description	40

4.3	Connecting the PCMCIA Card Reception Channel	42
	Precautions to be Taken when Connecting PCMCIA Card	43
	PCMCIA card product reference and installation	44
	Connection of the PCMCIA card	45
	Mounting of Cards and Cables.	46
	Visualization of operating status of TSX FPP 20 PCMCIA card	49
	Visual diagnostics for TSX FPP 20 PCMCIA card	50
4.4	Connection of the TSX FPP 20 card	51
	Connecting the TSX FPP 20 card	51
4.5	Summary of Connection Devices.	52
	Summary of Connection Equipment	52
4.6	Precautions when Connecting PCMCIA Cards	53
	Precautions for Connecting PCMCIA Cards	53
4.7	Consumption of PCMCIA Cards	54
	Power consumption of PCMCIA card.	54
	Part III Software implementation for Fipway communication	55
Chapter 5	Installation methodology.	57
	Introduction	57
Chapter 6	Communication via Fipway network: General	59
6.1	Introduction to Fipway communication	60
	Brief description of the Fipway network	61
	Communication function.	62
	Use of common words	64
	Use of shared tables	66
6.2	Characteristics	67
	Hardware compatibilities	68
	Software compatibility	69
	Performance.	70
	Operating mode	71
Chapter 7	Configuring Fipway communication	73
	Configuration Methodology for a Fipway Network	74
	Fipway configuration screen	81
	Fipway parameters relating to telegrams and the physical layer	83
	Fipway parameters relating to common data	84
	Example of a shared table configuration	86

Chapter 8	Debugging Fipway communication	89
	Fipway debug screen	90
	Fipway debugging parameters	92
	Requests Available for Testing a Communication Channel	94
	How to Test a Channel with the Identification and Mirror Requests	95
	How to Test a Channel Using Requests	97
	How to access the module diagnostics and channel diagnostics functions of a Fipway device	98
Chapter 9	Fipway communication language objects	101
9.1	Fipway communication language objects and IODDTs	102
	Introduction to Fipway communication language objects	103
	Implicit Exchange Language Objects Associated with the Application-Specific Function	104
	Explicit Exchange Language Objects Associated with the Application-Specific Function	105
	Management of Exchanges and Reports with Explicit Objects	107
9.2	Language Objects and Generic IODDT Applicable to Communication Protocols	111
	Details of IODDT Implicit Exchange Objects of Type T_COM_STS_GEN	112
	Details of IODDT Explicit Exchange Objects of Type T_COM_STS_GEN	113
9.3	Language objects and IODDTs associated with Fipway communication	115
	Details of the implicit exchange objects of the T_COM_FPW IODDT	116
	Details of the Explicit Exchange Objects of the T_COM_FPW IODDT	119
	Language Objects Associated with Configuration	122
	Details of the Explicit Exchange Objects for a Fipway Function	123
9.4	The IODDT Type T_GEN_MOD Applicable to All Modules	124
	Details of the Language Objects of the T_GEN_MOD-Type IODDT	124
Index	127

Safety Information



Important Information

NOTICE

Read these instructions carefully, and look at the equipment to become familiar with the device before trying to install, operate, service, or maintain it. The following special messages may appear throughout this documentation or on the equipment to warn of potential hazards or to call attention to information that clarifies or simplifies a procedure.



The addition of this symbol to a “Danger” or “Warning” safety label indicates that an electrical hazard exists which will result in personal injury if the instructions are not followed.



This is the safety alert symbol. It is used to alert you to potential personal injury hazards. Obey all safety messages that follow this symbol to avoid possible injury or death.

DANGER

DANGER indicates a hazardous situation which, if not avoided, **will result in** death or serious injury.

WARNING

WARNING indicates a hazardous situation which, if not avoided, **could result in** death or serious injury.

CAUTION

CAUTION indicates a hazardous situation which, if not avoided, **could result in** minor or moderate injury.

NOTICE

NOTICE is used to address practices not related to physical injury.

PLEASE NOTE

Electrical equipment should be installed, operated, serviced, and maintained only by qualified personnel. No responsibility is assumed by Schneider Electric for any consequences arising out of the use of this material.

A qualified person is one who has skills and knowledge related to the construction and operation of electrical equipment and its installation, and has received safety training to recognize and avoid the hazards involved.

BEFORE YOU BEGIN

Do not use this product on machinery lacking effective point-of-operation guarding. Lack of effective point-of-operation guarding on a machine can result in serious injury to the operator of that machine.

WARNING

UNGUARDED EQUIPMENT

- Do not use this software and related automation equipment on equipment which does not have point-of-operation protection.
- Do not reach into machinery during operation.

Failure to follow these instructions can result in death, serious injury, or equipment damage.

This automation equipment and related software is used to control a variety of industrial processes. The type or model of automation equipment suitable for each application will vary depending on factors such as the control function required, degree of protection required, production methods, unusual conditions, government regulations, etc. In some applications, more than one processor may be required, as when backup redundancy is needed.

Only you, the user, machine builder or system integrator can be aware of all the conditions and factors present during setup, operation, and maintenance of the machine and, therefore, can determine the automation equipment and the related safeties and interlocks which can be properly used. When selecting automation and control equipment and related software for a particular application, you should refer to the applicable local and national standards and regulations. The National Safety Council's Accident Prevention Manual (nationally recognized in the United States of America) also provides much useful information.

In some applications, such as packaging machinery, additional operator protection such as point-of-operation guarding must be provided. This is necessary if the operator's hands and other parts of the body are free to enter the pinch points or other hazardous areas and serious injury can occur. Software products alone cannot protect an operator from injury. For this reason the software cannot be substituted for or take the place of point-of-operation protection.

Ensure that appropriate safeties and mechanical/electrical interlocks related to point-of-operation protection have been installed and are operational before placing the equipment into service. All interlocks and safeties related to point-of-operation protection must be coordinated with the related automation equipment and software programming.

NOTE: Coordination of safeties and mechanical/electrical interlocks for point-of-operation protection is outside the scope of the Function Block Library, System User Guide, or other implementation referenced in this documentation.

START-UP AND TEST

Before using electrical control and automation equipment for regular operation after installation, the system should be given a start-up test by qualified personnel to verify correct operation of the equipment. It is important that arrangements for such a check be made and that enough time is allowed to perform complete and satisfactory testing.

WARNING

EQUIPMENT OPERATION HAZARD

- Verify that all installation and set up procedures have been completed.
- Before operational tests are performed, remove all blocks or other temporary holding means used for shipment from all component devices.
- Remove tools, meters, and debris from equipment.

Failure to follow these instructions can result in death, serious injury, or equipment damage.

Follow all start-up tests recommended in the equipment documentation. Store all equipment documentation for future references.

Software testing must be done in both simulated and real environments.

Verify that the completed system is free from all short circuits and temporary grounds that are not installed according to local regulations (according to the National Electrical Code in the U.S.A, for instance). If high-potential voltage testing is necessary, follow recommendations in equipment documentation to prevent accidental equipment damage.

Before energizing equipment:

- Remove tools, meters, and debris from equipment.
- Close the equipment enclosure door.
- Remove all temporary grounds from incoming power lines.
- Perform all start-up tests recommended by the manufacturer.

OPERATION AND ADJUSTMENTS

The following precautions are from the NEMA Standards Publication ICS 7.1-1995 (English version prevails):

- Regardless of the care exercised in the design and manufacture of equipment or in the selection and ratings of components, there are hazards that can be encountered if such equipment is improperly operated.
- It is sometimes possible to misadjust the equipment and thus produce unsatisfactory or unsafe operation. Always use the manufacturer's instructions as a guide for functional adjustments. Personnel who have access to these adjustments should be familiar with the equipment manufacturer's instructions and the machinery used with the electrical equipment.
- Only those operational adjustments actually required by the operator should be accessible to the operator. Access to other controls should be restricted to prevent unauthorized changes in operating characteristics.

About the Book



At a Glance

Document Scope

This manual describes the implementation of hardware and software for Fipway communication with Premium and Atrium PLCs.

Validity Note

This documentation is valid for EcoStruxure™ Control Expert 14.0 or later.

The technical characteristics of the devices described in the present document also appear online. To access the information online:

Step	Action
1	Go to the Schneider Electric home page www.schneider-electric.com .
2	In the Search box type the reference of a product or the name of a product range. <ul style="list-style-type: none">• Do not include blank spaces in the reference or product range.• To get information on grouping similar modules, use asterisks (*).
3	If you entered a reference, go to the Product Datasheets search results and click on the reference that interests you. If you entered the name of a product range, go to the Product Ranges search results and click on the product range that interests you.
4	If more than one reference appears in the Products search results, click on the reference that interests you.
5	Depending on the size of your screen, you may need to scroll down to see the data sheet.
6	To save or print a data sheet as a .pdf file, click Download XXX product datasheet .

The characteristics that are presented in the present document should be the same as those characteristics that appear online. In line with our policy of constant improvement, we may revise content over time to improve clarity and accuracy. If you see a difference between the document and online information, use the online information as your reference.

Product Related Information

WARNING

UNINTENDED EQUIPMENT OPERATION

The application of this product requires expertise in the design and programming of control systems. Only persons with such expertise should be allowed to program, install, alter, and apply this product.

Follow all local and national safety codes and standards.

Failure to follow these instructions can result in death, serious injury, or equipment damage.

Part I

Introduction to Fipway communication

Chapter 1

Introduction to Fipway communication

Introduction to communication

At a Glance

The communication function allows data to be exchanged between all devices connected on a bus or a network.

This function applies:

- to specific communication modules mounted in-rack,
- to processors via PCMCIA cards.

Type of communication

The communication function covered in this manual is the Fipway function

Software implementation

The section on software implementation in this manual is identical to that for Premium and Atrium PLCs.

Part II

Hardware implementation for Fipway communication

Subject of this Part

This part presents the installation of hardware for Fipway communication.

What Is in This Part?

This part contains the following chapters:

Chapter	Chapter Name	Page
2	Introduction to hardware implementation	19
3	Implementation of TSX SCY 21601 module	23
4	Implementation of PCMCIA Cards	37

Chapter 2

Introduction to hardware implementation

Aim of this Chapter

This chapters covers general points relating to different devices used for Fipway communication.

What Is in This Chapter?

This chapter contains the following topics:

Topic	Page
Devices used for communication functions	20
Fipway Architecture	21
Operating standards	22

Devices used for communication functions

At a Glance

The architecture below shows the Fipway network and its various component devices:

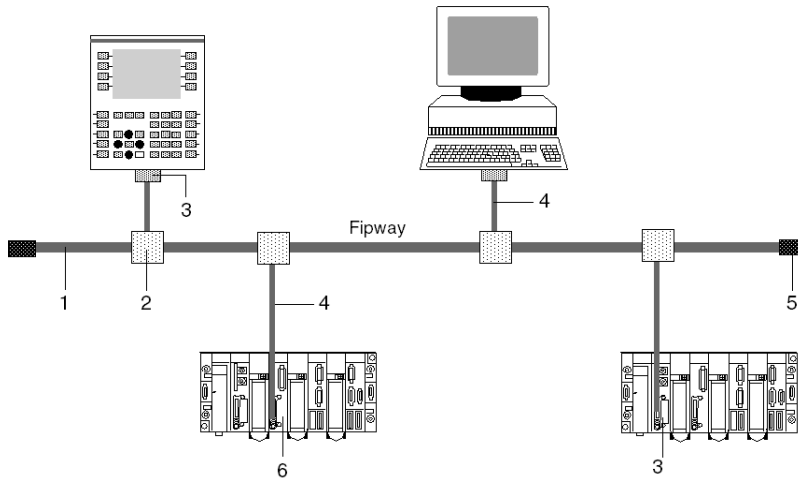

Description

The following table lists the devices on the network:

Number	Product reference	Description
1	TSX FP CA/CR...	Main cable
2	TSX FP ACC4	Branching device
3	TSX FPP 20	PCMCIA card
4	TSX FP CG 010/030	Branch connector cable
5	TSX FP ACC7	Line terminator
6	TSX SCY 21601	Module

Fipway Architecture

Description

Example of a Fipway architecture:

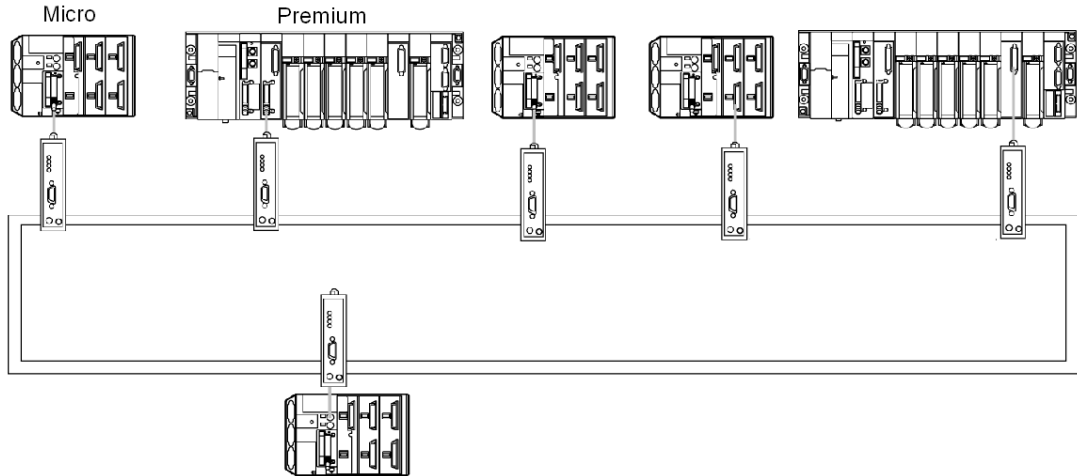

A large number of Schneider products which operate on the Fipway network can be connected to the OZD FIP G3 transceiver:

- Premium TSX P57 •54 and TSX PCI57 354 PLCs (programmed using Unity Pro V2.0), equipped with a TSX FPP OZD 200 or TSX FPP 200 card.
- PC with a slot for a type III PCMCIA card: communication is performed by the TSX FPP 20 card.
- PC with an ISA bus: communication is performed by the TSX FPC 10 ISA card, and a special driver, supplied with the TSX FPP OZD 200 or TSX FPP 200 card, must be installed in addition to the standard driver.

NOTE: Unity Pro is the former name of Control Expert for version 13.1 or earlier.

For a PC used on FIPWAY, install the driver using the TLXLFFPCOZD diskette supplied with the PCMCIA TSXFPP200 card with the kit product references TSX FPP OZD 200 or TSX FPP 200. The address of the PC station cannot be 0 or 1.

NOTE: TSX FP ACC6 and TSX FP ACC8M repeaters are not compatible with architectures using OZD FIP G3 transceivers.

NOTE: The TSX DM OZD 01 manual gives all the characteristics of HIRSCHMANN OZD FIP G3 transceivers.

Operating standards

General

TSX SCY 21601 and **PCMCIA** module communication cards comply with the following international norms and standards:

- US Standards: UL508, IEC 1131-2
- CANADA Standards: CSA C22.2/1 42
- Compliance with regulations: FCC-B
- EC labeling
- PCMCIA mechanical standard type III E
- PCMCIA 2.01

The link built into the **TSX SCY 21601** module complies with communication standards:

- Uni-Telway
- Modbus
- X-Way

The **TSX FPP 20** Fipway PCMCIA card complies with the following communication standards:

- FIP protocol (link, network management)
- PCMCIA
- X-Way

Chapter 3

Implementation of TSX SCY 21601 module

Aim of this Chapter

This Chapter deals with implementation of the hardware for the **TSX SCY 21601** module.

What Is in This Chapter?

This chapter contains the following sections:

Section	Topic	Page
3.1	At a Glance	24
3.2	Description	25
3.3	Built-in Channel Specifications	27
3.4	TSX SCY 21601 Module's Host Channel Compatibility	28
3.5	Installation	29
3.6	Operation	31
3.7	Module Visual Diagnostics	32
3.8	Built-in Channel Connection	34

Section 3.1

At a Glance

Introduction

General

The **TSX SCY 21601** module can take PCMCIA communication cards.

It has two communication channels:

- A multi-protocol built-in channel (channel 0), RS485 isolated asynchronous serial link, supporting Uni-Telway, Jbus/Modbus or Character Mode protocols.
- A PCMCIA host channel (channel 1) which supports the following protocols:
 - Fipway cell network corresponding to the **TSX FPP 20** card.
 - Uni-Telway, Jbus/Modbus and Character Mode on an RS 232-D, Current Loop, or RS 485 link, corresponding to cards **TSX SCP 111, 112 and 114**.

NOTE: the built-in channel of the TSX SCY 21601 module is only compatible with a twin-wire RS 485 link.

Section 3.2

Description

Description

General

The **TSX SCY 21601** module is a standard format module which can be inserted into one of the slots on a Premium/Atrium PLC station rack.

NOTE: Remoting of the X-Bus is not authorized for this module.

Illustration:

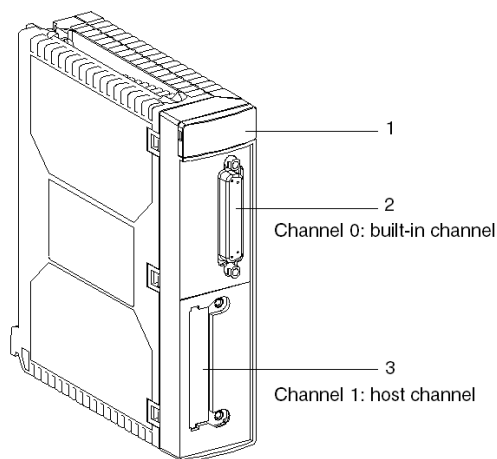

This module is made up of the following elements:

Number	Description
1	Three indicator LEDs on the front of the module: <ul style="list-style-type: none"> ● RUN and ERR show the module's status. ● CH0 displays the status of the built-in serial link channel (channel 0) communication.
2	Built-in channel has a 25 pin SUB-D female connector, half duplex mode (channel 0) RS 485 base link: <ul style="list-style-type: none"> ● Uni-Telway ● Modbus ● Character Mode
3	PCMCIA type III (channel 1) host channel.

Insertable cards

Different communication cards which can be fitted to the TSX SCY 21601 module's host channel:

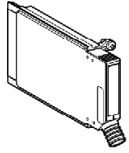
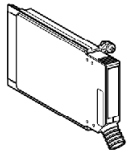
Type	Description	Illustration
TSX FPP 20	Fipway network cards	
TSX SCP 111	Multiprotocol card (Uni-Telway, Modbus/Jbus, Character Mode), RS 232 D, 9 non-isolated signals.	
TSX SCP 112	Multiprotocol card (Uni-Telway, Modbus/Jbus, Character Mode), current loop (BC 20 mA).	
TSX SCP 114	Multiprotocol card (Uni-Telway, Modbus/Jbus, Character Mode), RS 485, RS 422 compatible isolated.	

Section 3.3

Built-in Channel Specifications

Characteristics of the built-in channel

General

The TSX SCY 21601 module's built-in channel includes:

- An RS 485 Physical Interface.
- A twisted double pair link.
- Uni-Telway, Modbus and Character Mode protocols.

Specifications

Specifications of the built-in link for the following 3 protocols:

	Uni-Telway	Modbus	Character Mode
Type	Master/slave	Master/slave	Half duplex
Data transfer rate	9600 bits/sec. Parameters can be set from 1200 to 19200 bits/sec.	9600 bits/sec. Parameters can be set from 1200 to 19200 bits/sec.	9600 bits/sec. Parameters can be set from 1200 to 19200 bits/sec.
Number of devices	28	28	-
Number of slave addresses	98	98	-
Length of bus without branching	1000 m	1300 m	1000 m
Message Size	240 bytes	256 bytes	4 Kb
Utilities	UNI-TE Master/slave Master/slave Messaging Requests	Word/bit Reading Word/bit Writing Diagnostics	Character string send/receive

Section 3.4

TSX SCY 21601 Module's Host Channel Compatibility

TSX SCY 21601 Host Channel Compatibility

General

The cards supported by the host channel are:

- The **TSX FPP 20** card is compatible with the following Fipway devices:
 - Model 40 PLCs (**TSX 47-455**, **TSX 67-455**, etc.) in versions later than 5.0.
 - TSX 17 PLCs
 - PC compatible PLCs connected with **TSX FPC10** and **TSX FPC 20** cards.
- PCMCIA cards: **TSX SCP 111**, **112**, **114** which communicate with Premium/Atrium, 1000 Series and Modicon PLCs and other Uni-Telway, Modbus and Character Mode compatible products. PCMCIA cards are also Jbus/Modbus compatible with 1000 Series PLCs

NOTE: The **TSX FPP 10** card is not supported by the host channel.

Section 3.5

Installation

Installation

General

The **TSX SCY 21601** module is installed in a Premium/Atrium PLC station rack.

It forms part of an X-Way network architecture based on Series 7, Micro, Premium and Atrium PLCs.

This communication module accords the PLC station the following:

- An insulated RS 485 multiprotocol communication channel.
- A standard PCMCIA communication card slot.

The **TSX SCY 21601** module can be fixed in any available slot in a Premium/Atrium PLC station rack.

Maximum number

A **TSX SCY 21601** module can support a maximum of 2 application-specific communication channels, a built-in RS 485 channel and a channel from the PCMCIA card which can be integrated into the module.

Since the maximum number of channels managed by a PLC station depends on the type of processor installed, the number of **TSX SCY 21601** modules in a station will therefore depend on:

- The type of processor installed.
- The number of application-specific channels already used, other than communication channels.

The user will therefore have to count the total number of channels in use on the PLC station and determine the number of **TSX SCY 21601** modules which can be used.

NOTE: Application-specific channel recognition is defined in the Premium (*see Premium and Atrium using EcoStruxure™ Control Expert, Processors, racks and power supply modules, Implementation Manual*) / Atrium (*see Premium and Atrium using EcoStruxure™ Control Expert, Processors, racks and power supply modules, Implementation Manual*) PLC installation Manual.

Connection/Disconnection

The **TSX SCY 21601** module can be **wired or unwired when switched on**. This device **does not** have a backup memory function. When the module is disconnected from the rack, its internal memory is erased. The module goes through an initialization phase once it is reconnected.

A **TSX SCY 21601** module which has a PCMCIA card installed may be disconnected when the power is on.

NOTE: In contrast, PCMCIA cards **cannot be removed** when switched on.

Section 3.6

Operation

Operation

General

The **TSX SCY 21601** module manages two independent communication channels which each have their own functions:

- Channel 0 deals with Uni-Telway, Modbus and Character Mode protocols on an isolated physical link, and with standardized RS 485 half duplex with a speed limited to 19200 bits per second.
- Channel 1 receives one of the following PCMCIA communication cards:
 - Cell network: **TSX FPP 20** Fipway card.
 - Field Bus: **TSX SCP 111** (RS232), **TSX SCP 112** (current loop), **TSX SCP 114** (RS 422/RS 485) Uni-Telway, Jbus/Modbus and Character mode cards.

The choice of PCMCIA card and protocol is made when the **TSX SCY 21601** module's communication channels are configured using Control Expert software.

Section 3.7

Module Visual Diagnostics

Visual diagnostics of the module





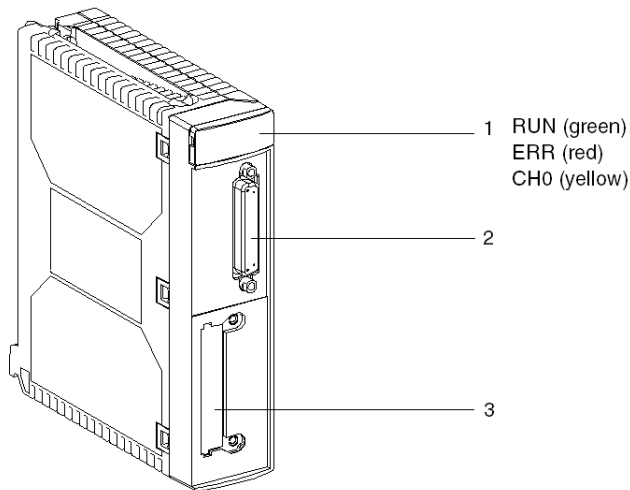















General

Three LEDs are built into the front panel of **TSX SCY 21601** modules. These LEDs allow you to visualize information on the **operating state of the module** and on the **communication status** of the **built-in** serial link channel.



The host channel's communication status is determined by the ERR and COM LEDs in the PCMCIA cards on the serial or Fipway link Visual diagnostics for PCMCIA cards ([see page 50](#))

Meaning of LEDs:

RUN	ERR	CH0	Comments
	(1)	(1)	Module powered-down or module failure
			No communication on the built-in channel.
		 (2)	Communication on built-in channel.
		(1)	Serious fault on built-in channel.
			Fault on built-in channel. Configuration fault. No device OK on channel.
			Device fault on built-in channel.
			Self-tests running
Key:			
 Off		 Flashing	
 On		(1) Indifferent state. (2) Displays line activity.	

Section 3.8

Built-in Channel Connection

Aim of this Section

This section describes the different ways to connect the built-in channel of **TSX SCY 11601/21601** modules.

What Is in This Section?

This section contains the following topics:

Topic	Page
At a Glance	35
Power consumption of the TSX SCY 21601 module	36

At a Glance

General Points

The **TSX SCY 21601** module has a variety of devices (*see Premium and Atrium using EcoStruxure™ Control Expert, Asynchronous Serial Link, User Manual*) for connecting the channel built into the buses.

Power consumption of the TSX SCY 21601 module

Values

This table shows the power consumption of a **TSX SCY 21601** communication module without a PCMCIA card or a connection to the built-in channel:

Voltage	Typical Current	Maximum Current	Power dissipation
5 Volts	350 mA	420 mA	2.1 W max.

Chapter 4

Implementation of PCMCIA Cards

Aim of this Chapter

This chapter provides an overview of the hardware implementation for PCMCIA communication cards on Premium/Atrium PLCs.

What Is in This Chapter?

This chapter contains the following sections:

Section	Topic	Page
4.1	At a Glance	38
4.2	Description	40
4.3	Connecting the PCMCIA Card Reception Channel	42
4.4	Connection of the TSX FPP 20 card	51
4.5	Summary of Connection Devices	52
4.6	Precautions when Connecting PCMCIA Cards	53
4.7	Consumption of PCMCIA Cards	54

Section 4.1

At a Glance

Introduction

General

Premium/Atrium PLC stations connect to communication networks, buses and links through PCMCIA communication cards.

The card to be connected is a metal device whose dimensions comply with PCMCIA extended type III.

PCMCIA cards are installed in the host slot of the processor and/or **TSX SCY 21601** module in PLCs from the Premium family.

PCMCIA cards can also be used in devices which can host type III cards, such as **FT 2100** terminals or PC-compatible third-party devices, for example.

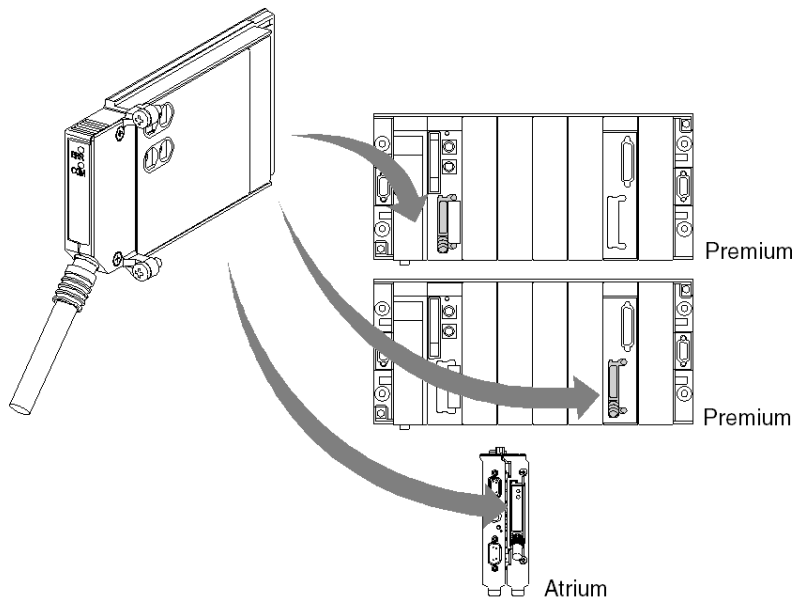

NOTE: It is prohibited to connect PCMCIA cards when the power is switched on.

PCMCIA cards are installed, operated and maintained using Control Expert programming and operation software for all PLCs in the Premium family.

TSX FFP 20 card

Fipway network PCMCIA card:

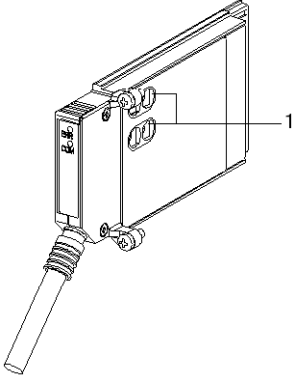
Functions	Illustration
<p>The TSX FFP 20 PCMCIA card supports the FIP physical layer. It is used to connect a Premium/Atrium station to a Fipway network, as well as to connect to devices of manufacturers who wish to connect their products to the Fipway network.</p> <p>The card is fitted with four rotary switches (marked "1" in the illustration) which make it possible to encode the network number and station.</p>	 <p>The illustration shows a side view of the TSX FFP 20 PCMCIA card. It is a rectangular card with a connector on the left side. Four rotary switches are located on the top edge of the card, each marked with the number "1". A line points from the label "1" to the rightmost of these switches.</p>

Section 4.2

Description

Description

General

PCMCIA type III (extended) communication cards are built into a metal case with the following dimensions:

- length: 85.5 mm
- width: 51 mm
- height: 10 mm

The front of the card is designed to display communication status and provides the physical connection to the network.

Mechanical Configuration

The mechanical configuration of the card must be adapted by mounting a removable cover, depending on the type of installation desired:

Type of Installation	Configuration	Illustration
Installation on a Premium type processor or on a TSX SCY 21601 communication module	Removable cover with wings. Screws are provided to fix it to the host module (marked 3 on illustration).	
Installation on an Atrium type processor	Removable cover with wings. Screws are provided to fix it to the Atrium processor (marked 2 on illustration).	
Installation onto a PC compatible device	Removable cover (marked 1 on illustration)	

NOTE: The covers with wings, mounted on PCMCIA cards, prevent any accidental removal when switched on and guarantee that the card remains in good working order.

The two covers **1** and **3** are provided with the PCMCIA card. Cover **2** is provided with the Atrium processor.

Connection to the network is achieved by connecting the link cable to the front of the card. A guidance system is used to prevent anything being mounted incorrectly.

The product reference label informs the user of the type of physical layer supported by the card.

Section 4.3

Connecting the PCMCIA Card Reception Channel

Aim of this Section

This section describes the installation of PCMCIA cards in the reception channel of the **TSX SCY 21601** module.

What Is in This Section?

This section contains the following topics:

Topic	Page
Precautions to be Taken when Connecting PCMCIA Card	43
PCMCIA card product reference and installation	44
Connection of the PCMCIA card	45
Mounting of Cards and Cables	46
Visualization of operating status of TSX FPP 20 PCMCIA card	49
Visual diagnostics for TSX FPP 20 PCMCIA card	50

Precautions to be Taken when Connecting PCMCIA Card

General

 CAUTION
UNEXPECTED EQUIPMENT OPERATION Power off the device before handling the PCMCIA card. Failure to follow these instructions can result in injury or equipment damage.

When removing or inserting the card, the unit is not guaranteed to be operational. There is no procedure for a warm start between the PCMCIA card and the **TSX SCY 21601** host device.

In the event that the operating environment does not allow the application to be stopped by switching off the PLC processor, you are recommended to remove the **TSX SCY 21601** module with the PCMCIA card.

The PCMCIA card must be equipped with a PLC version cover and be screwed into the **TSX SCY 21601** host module before the unit is switched on (mechanical configuration (*see page 41*)).

PCMCIA card product reference and installation

Installation

The PCMCIA card can be installed in the host channels of processors and the TSX SCY 21601 module.

Application-specific channels and network connections

Table showing the number of application-specific channels or network connections used by PCMCIA card:

Product references	Number of application-specific channels		Number of Network Connections
	Card in the processor	Card in the TSX SCY 21601 module	
TSX FPP 20	-	-	1

Number of "application-specific" channels supported by the type of processor:

- Premium (*see Premium and Atrium using EcoStruxure™ Control Expert, Processors, racks and power supply modules, Implementation Manual*)
- Atrium (*see Premium and Atrium using EcoStruxure™ Control Expert, Processors, racks and power supply modules, Implementation Manual*)

Connection of the PCMCIA card

General

Connecting PCMCIA cards requires specific cables and connection devices, depending on the type of models.

Fipway network card

The **TSX FPP 20** Fipway card is connected via the host channel using a **TSX FPCG 10** or **TSX FPCG 30** cable.

Mounting of Cards and Cables

PCMCIA Card Details

Illustration:

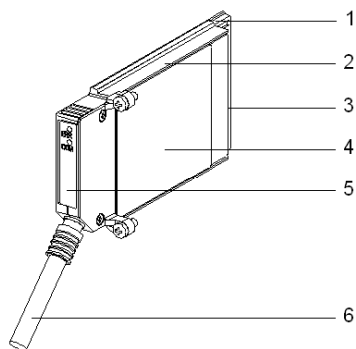

PCMCIA cards are made up of the following elements:

Number	Designation	Comments
1	Equipped card	Receives electronic components.
2	Body made of zamac	-
3	PCMCIA connector	Connector with 20 connection points.
4	Upper cover	Houses the product reference label which shows the type of PCMCIA card
5	Removable cover	Ensures the card is displayed in its slot. The names of the two LEDs are printed on the front of the removable cover. This cover is also used to fix the PCMCIA card on the processor or on the TSX SCY 21601 module.
6	Linking cable with ferule	The ferule placed on the end of the PCMCIA card cable side prevents the cable being pinched by the removable cover. This ferule also eliminates the risk of causing a bending radius which can damage the quality of the link.

Assembly for TSX P57 1•4 to TSX P57 5•4 Processors

To assemble the transmission card for the processor or the TSX SCY 21601, first remove the cover which is screwed on the device and then follow the instructions below:

Step	Action	Illustration
1	Connect the cable	<p>Host slot on processor TSX P57 1•4 to TSX P57 4•4 or TSX SCY 21601</p>
2	Place the appropriate cover on the device, taking care to insert the ferrule in the slot provided in order to fix the cable to the card.	
3	Screw on the cover.	
4	Insert the card in the slot provided in the host device.	
5	Screw in the card to stop it being moved when switched on, and to ensure it functions effectively.	

Assembly for TSX P57 5•4 Processors

To assemble the card in TSX P57 5•4 type processors, follow the instructions below:

Step	Action	Illustration
1	Connect the cable.	
2	Place the appropriate cover on the device, taking care to insert the ferrule in the slot provided in order to fix the cable to the card.	
3	Screw on the cover.	

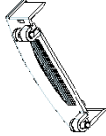
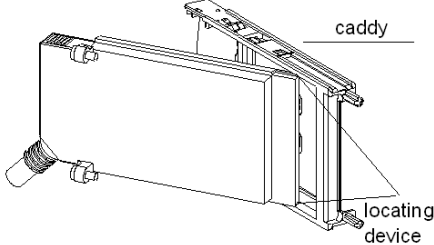
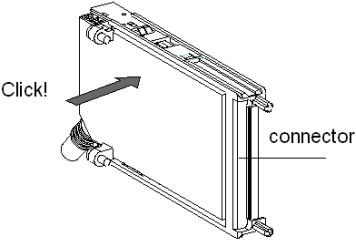
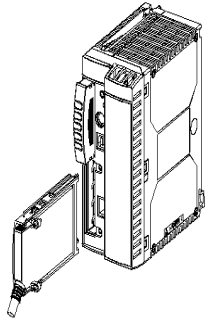
Step	Action	Illustration
4	Remove the plastic cover from the caddy.	
5	Guide the card into the caddy from an oblique angle using the 2 locating devices.	
6	Slide the card into the caddy until it stops. The card is now firmly attached to the caddy.	
7	Insert the assembly (caddy and card) in the slot provided in the host device.	
8	Screw in the card to stop it being moved when switched on, and to ensure it functions effectively.	

Visualization of operating status of TSX FPP 20 PCMCIA card

General

Two diagnostics LEDs are located on the front of the card. They inform the user on how exchanges between the device supporting the PCMCIA card and the related device are functioning.

Illustration

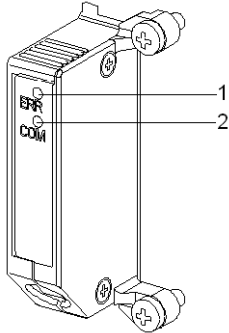
Number	Description	Illustration
1	Error "ERR" LED (normally off) displays errors. This is red.	 A technical drawing of a PCMCIA card. On the front face, there are two LEDs. The top one is labeled 'ERR' and the bottom one is labeled 'COM'. Two lines with numbers 1 and 2 point to these LEDs respectively. The card has a gold-plated edge connector on the left side and a latch on the right side.
2	The "COM" communication LED displays the line activity. This LED is yellow.	













Visual diagnostics for TSX FPP 20 PCMCIA card

General

Depending on their state, LEDs of the PCMCIA card indicate the operating mode for communication, as well as the card diagnostics.

TSX FPP 20 card

State of LEDs:

ERR	COM	Meaning	Corrective actions
		Device switched off No dialog	Check supply, Card inoperational
		Operating normally	-
	(1)	Serious fault	Change the card
		Functional fault	Check the configuration and the connection to the communication bus
		Functional fault	Check the configuration
Key:			
	Off		
	On		
	Flashing		
(1)	Indifferent state		

NOTE: The "ERR" LED, when flashing, indicates that an external fault has occurred. These faults are:

- Line fault
- Station already present on the network
- Incorrect station-network address coding (rotary switch coding)

Section 4.4

Connection of the TSX FPP 20 card

Connecting the TSX FPP 20 card

General

The **TSX FPP 20** PCMCIA card is connected to the Fipway network using a connector such as **TSX FP ACC4** or **TSX FP ACC 12**.

To connect the PCMCIA card to the ACC4/ACC12 connector the user has the choice of:

- Either a 1 m cable, product reference **TSX FP CG 010**.
- Or a 3 m cable, product reference **TSX FP CG 030**.

The elements required for connecting a Premium/Atrium PLC to the Fipway network are:

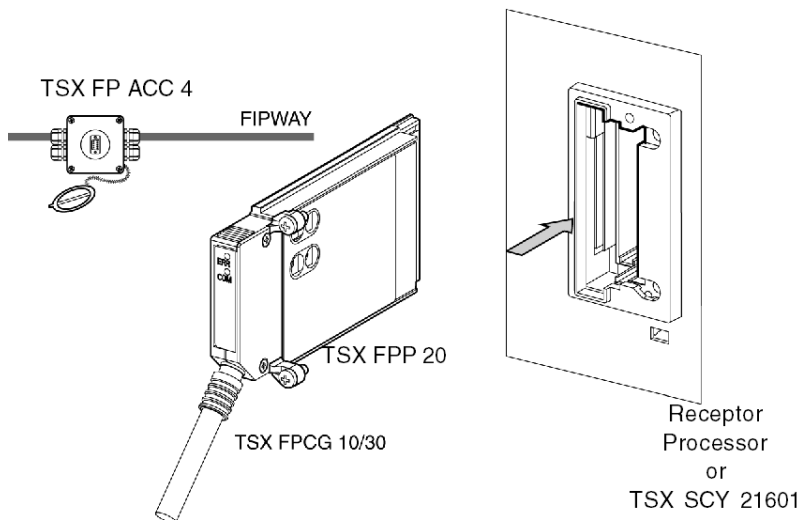

NOTE: Important: TSX FP CG 010/030 cables connect and disconnect from the PCMCIA card only when power is switched off.

Section 4.5

Summary of Connection Devices

Summary of Connection Equipment

TSX FPP 20 card

Type of cable	Product reference	Designation
Fipway/Fipio cable	TSX FP CG 010	Connection cable, L=1 m.
Fipway/Fipio cable	TSX FP CG 030	Connection cable, L=3 m.
Connection device	TSX FP ACC4	Fipway/Fipio connection device.
Connection device	TSX FP ACC12	Fipway/Fipio connection device.

Section 4.6

Precautions when Connecting PCMCIA Cards

Precautions for Connecting PCMCIA Cards

Important

Cards must be connected or disconnected in the host device (processor or **TSX SCY 21601**) **when the device is switched off**.

The ferrule, placed in direct contact with the PCMCIA card device, is used to handle electrical interference carried by the link cable braids.

Section 4.7

Consumption of PCMCIA Cards

Power consumption of PCMCIA card

TSX FPP 20

Power consumption table:

Voltage	Typical Current	Maximum Current	Power dissipation
5 volts	280 mA	330 mA	1.65 W max.

Part III

Software implementation for Fipway communication

Subject of this Part

This part introduces software implementation for Fipway communication with Control Expert software.

What Is in This Part?

This part contains the following chapters:

Chapter	Chapter Name	Page
5	Installation methodology	57
6	Communication via Fipway network: General	59
7	Configuring Fipway communication	73
8	Debugging Fipway communication	89
9	Fipway communication language objects	101

Chapter 5

Installation methodology

Introduction

Introduction

Hardware installation for the application-specific modules is carried out using the different Control Expert editors:

- in offline mode,
- and in online mode.

If you do not have a processor for connection purposes, Control Expert enables you to carry out a first-level test using a simulator. In this case installation (*see page 58*) is different.

The recommended installation sequence is defined below, but certain phases can be modified (for example, beginning with the configuration phase).

Installation using processor

The following table introduces the different installation phases when using a processor.

Phase	Description	Mode
Logical network	Creation and configuration of the logical Fipway network.	Offline
Declaration of variables	Declaration of the IODDT-type variables for application-specific modules and the project variables.	Offline (1)
Programming	Project programming.	Offline (1)
Configuration	Declaration of modules and the Fipway card.	Offline
	Module channel configuration.	
	Association of the logical Fipway network with the Fipway card.	
	Entry of the configuration parameters.	
Association	Association of the IODDTs with the configured modules (variables editor).	Offline (1)
Generation	Project generation (analyzing and editing links).	Offline
Transfer	Transfer of the project to the PLC.	Online
Adjustment/Debugging	Project debugging from debug screens, animation tables.	Online
	Modification of the program and adjustment parameters.	
Documentation	Building the documentation file and printing the different data relating to the project.	Connected (1)

Phase	Description	Mode
Operation/Diagnostics	Displaying the different data needed for running the project.	Online
	Project / module diagnostics.	
Legend		
(1)	These different phases can also be carried out in the other mode.	

Installation using simulator

Note: The simulator is only used for the discrete or analog modules.

The following table introduces the different installation phases when using the simulator.

Phase	Description	Mode
Declaration of variables	Declaration of the IODDT-type variables for application-specific modules and the project variables.	Offline (1)
Programming	Project programming.	Offline (1)
Configuration	Declaration of the modules.	Offline
	Module channel configuration.	
	Entry of the configuration parameters.	
Association	Association of the IODDTs with the configured modules (variables editor).	Offline (1)
Generation	Project generation (analyzing and editing links).	Offline
Transfer	Transfer project to simulator.	Online
Simulation	Program simulation without Inputs/Outputs.	Online
Adjustment/Debugging	Project debugging from debug screens, animation tables.	Online
	Modification of the program and adjustment parameters.	
Legend		
(1)	These different phases can also be carried out in the other mode.	

Chapter 6

Communication via Fipway network: General

Subject of Chapter

This Chapter introduces communication via the Fipway network and its services.

What Is in This Chapter?

This chapter contains the following sections:

Section	Topic	Page
6.1	Introduction to Fipway communication	60
6.2	Characteristics	67

Section 6.1

Introduction to Fipway communication

Aim of this Section

This Section gives a summary description of the Fipway network and its associated services.

What Is in This Section?

This section contains the following topics:

Topic	Page
Brief description of the Fipway network	61
Communication function	62
Use of common words	64
Use of shared tables	66

Brief description of the Fipway network

Introduction

The Fipway network complies fully with the FIP standard.

A Fipway communication channel includes three basic functions:

- the inter-station message handling function for routing messages,
- the send/receive telegram function,
- the common word (%NW) or shared table production/consumption function.

Communication function

At a Glance

Fipway communication provides the following services:

- the message handling service,
- the common words service,
- the shared table service.

Messaging

The PCMCIA card messaging service enables:

- exchange of messages between two network stations,
- message broadcasting to all network stations,
- sending/receiving telegrams between stations whose address is between 0 and 15,
- sending the devices the messages to be routed to another network (routing function).

The exchange of messages between the PLC and the PCMCIA card is synchronous.

Common words

The common words service is constituted of a set of dedicated %NW words. Depending on its software configuration, each network station whose address is between 0 and 31 can access the database in read or write mode.

Updates are performed implicitly at the start of the cycle for read operations and at the end of the cycle for write operations. The application program consists simply of writing or reading these words.

Word addressing is as follows:

%NWn.s.d

The following table describes addressing parameters for common words:

Parameter	Description
n	Network number
s	Station number
d	Word number

NOTE: The network number is used to select the network on which common words are exchanged in a multi-network configuration.

Shared table

This service is used to exchange a table of internal words (%MW) divided into as many areas as there are stations whose address is between 0 and 31 in the Fipway network.

The principle depends upon distribution by each PLC of a word memory area to the other network stations.

Updates are performed implicitly and independently of the application program's execution cycle. The program consists simply of writing or reading the words.

NOTE: When configuring and assigning fields, be careful to avoid creating memory conflicts between stations.

Use of common words

At a Glance

The following examples deal with the use of the common words service in mono- and multi-network architectures.

This service corresponds to the exchange of 4 words (%NW) per station. There can be 32 stations on the Fipway network

NOTE: That's right, these info can be found in the rest of the Fipway documentation, but it should be better to add these infos at the beginning of the Fipway configuration in the appropriated chapters, as required

Mono-network architecture

The example is as follows:

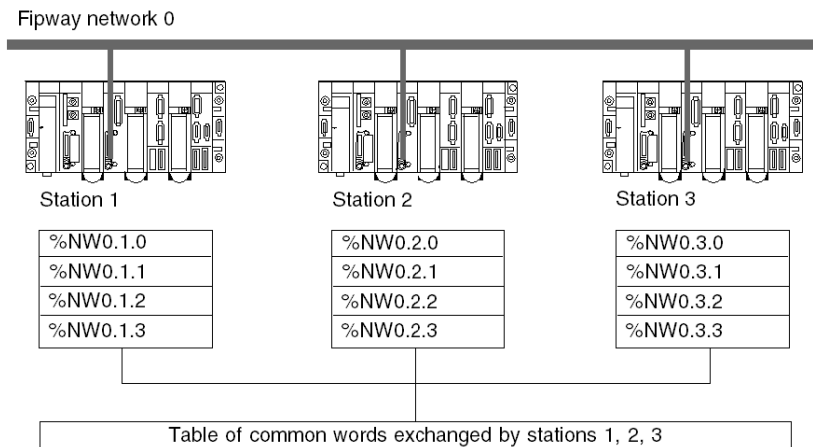

Three PLCs connected on a Fipway network (number 0) exchange data among themselves via the common words service.

This service corresponds to the exchange of 4 words (%NW) per PLC.

Multi-network architecture

The example is as follows:

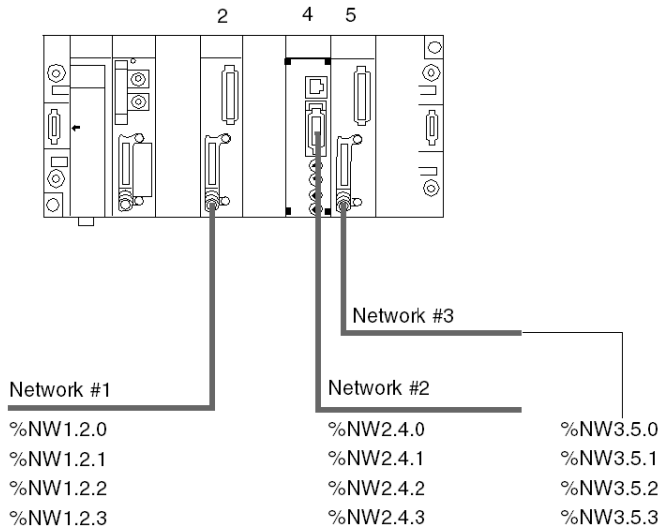

In a multi-network (*see EcoStruxure™ Control Expert, Operating Modes*) architecture, common words can be accessed through the network address of each module.

Reading and writing common words

The application program manages the contents of the different common words:

- reading common words originating from remote stations,
- writing common words from the local station.

The write or read syntax for a common word is identical to that of internal words:

- %MW10 := %NW2.1.0: reading a common word,
- %NW2.2.3 := 357: writing a common word,

Use of shared tables

At a Glance

Three TSX 37 or TSX 57-type PLCs connected on a Fipway network must exchange data among themselves (production parameters, action reports, etc.) via the shared table service.

This service corresponds to the exchange of 32 words (%MW) per station. There can be 32 stations on the Fipway network.

Example

The following illustration provides an example:

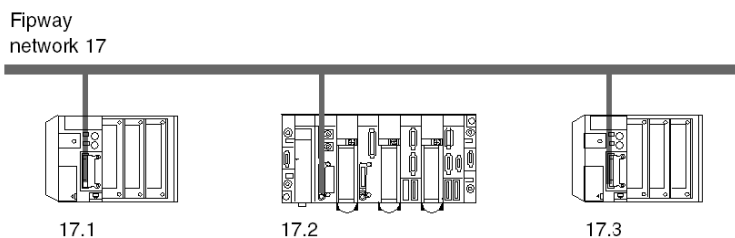

Station 1 exchanges a table starting from %MW200 of 10 words in length to %MW300 of station 2 and %MW400 of station 3.

Station 2 exchanges a table starting from %MW310 of 20 words in length to %MW210 of station 1 and %MW410 of station 3.

Station 3 exchanges a table starting from %MW430 of 5 words in length to %MW230 of station 1 and %MW330 of station 2.

Section 6.2

Characteristics

Aim of this Section

This Section introduces the characteristics and constraints of using Fipway communication.

What Is in This Section?

This section contains the following topics:

Topic	Page
Hardware compatibilities	68
Software compatibility	69
Performance	70
Operating mode	71

Hardware compatibilities

General

The binary digit rate for the network is 1 Mbits/s.

The length of a segment depends on its type of branches. Its maximum length is 1000 meters without relay.

When relays are used (optical or electrical), the maximum length between the two stations the furthest distance away depends upon the number of relays crossed.

The maximum length in kilometers is calculated using the following formula:

$L = 22 - (0.5 * R)$ where R is the number of relays crossed by the FIP data between the two stations.

The Fipway network is connected to Hirschmann optical transmitters with the PCMCIA TSX FPPOZD 200 card.

Availability

This type of communication is available for:

- Premium PLCs via:
 - the TSX FPP 20 PCMCIA card,
Set the network address between 0 to 127
Set the station address between 0 to 63
 - the TSX FPPOZD 200 PCMCIA card,
Set the network address between 0 to 127
Set the station address between 0 to 32

Capacity

One Fipway network segment enables connection of 36 devices. Devices for a Fipway network can be:

- stations with the constraint of a maximum of 32 stations per segment,
- stations with the constraint of a maximum of 32 relays per segment,

On all of the segments, a maximum of a 64 stations can be connected to the network.

Software compatibility

Message handling

The maximum frame size depends on the type of transaction:

- For a message, the maximum frame is 128 bytes.
- For a telegram, the maximum frame is 16 bytes.

Equally, the PCMCIA cards can process: 8 communication functions simultaneously (8 in receive and 8 in send mode).

- for messages, 8 communication functions simultaneously (8 in send and 8 in receive mode).
- for telegrams, one single communication function (one in send and one in receive mode).

Common words

The common words service is supported by the stations at addresses between 0 and 31.

This database is made up of a maximum of 128 words for all the stations.

Each station can produce a maximum of between 0 and 4 common words and consume the other common words on the network.

Shared table

The shared table service is supported by the stations at addresses between 0 and 31.

This database is made up of a maximum of 128 words for all the stations.

Each station can produce a maximum of between 1 and 32 words (defined in configuration mode) and consume the other words on the network.

Performance

Transaction time

The following table gives the transaction time between two stations:

		Receiving station	
		Cyclic	Periodic 50 ms
Sending station	Cyclic	50 ms	-
	Periodic 50 ms	120 ms	160 ms

The telegram exchange time between two stations is 21 ms.

Operating mode

At a Glance

The following diagram describes the operating mode of the TSX FPP 20 card.

General Diagram

The operating mode is as follows:

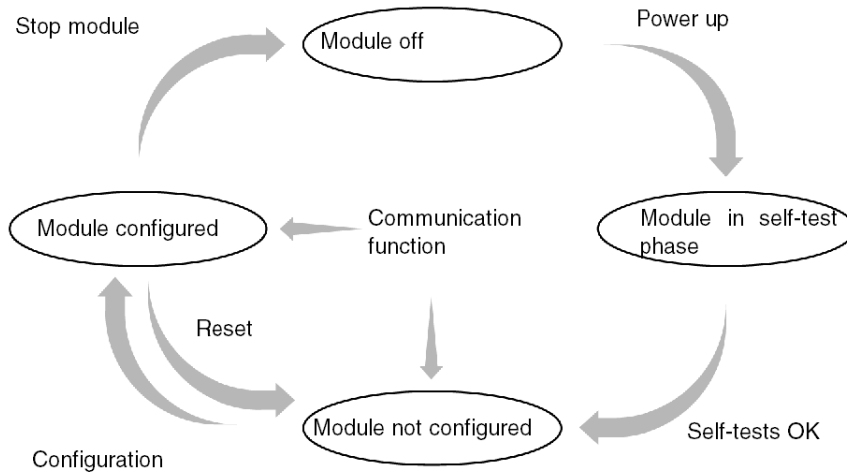

Operation

- After power-up, the module performs self-tests. During this phase, the LED indicators blink.
- If no configuration exists, the card operates in messaging service mode and can be configured with Control Expert.
- If there is a Control Expert application in the PLC, the application configuration is transmitted to the module and the module starts up.
- If a power outage occurs, the PLC processor carries out a warm restart. The module then relaunches its self-test procedures.

Chapter 7

Configuring Fipway communication

Subject of this Chapter

This Chapter describes the Configuration process during set-up of Fipway communication.

What Is in This Chapter?

This chapter contains the following topics:

Topic	Page
Configuration Methodology for a Fipway Network	74
Fipway configuration screen	81
Fipway parameters relating to telegrams and the physical layer	83
Fipway parameters relating to common data	84
Example of a shared table configuration	86

Configuration Methodology for a Fipway Network

At a Glance

Creation and configuration of a Fipway network involves 4 major stages:

- creation of a logical Fipway network,
- configuration of a logical Fipway network,
- declaration of the Fipway PCMCIA card,
- association of the card with the logical network.

These four methods are presented at a later point in this documentation.

NOTE: the advantage of this method is that from stage two onwards, you can devise your communication application (you are not obliged to have the hardware to begin work) and use the simulator to test its operation.

NOTE: the two first stages can be executed from the project browser, and the two following stages from the hardware configuration editor.

How to create a logical Fipway network

The following table introduces the procedure to follow for creating a logical Fipway network:

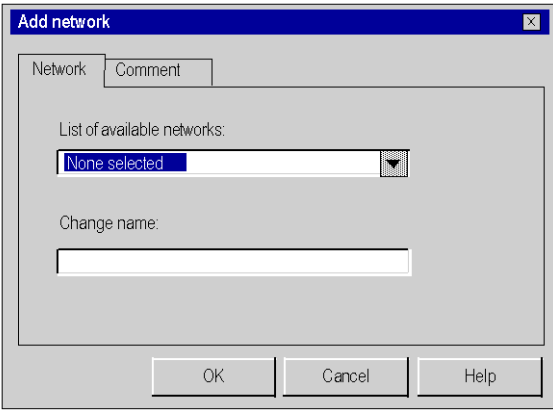
Step	Action
1	<p>Right-click the Network subdirectory of the Communication directory of the Project browser and select the New network option.</p> <p>Result:</p> 

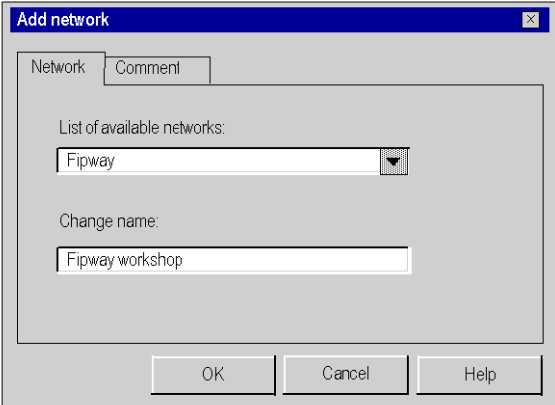
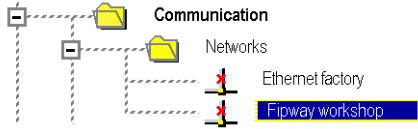
Step	Action
2	<p>Choose Fipway in the list of available networks and choose a meaningful name for your selection.</p> <p>Result:</p>  <p>Note: when you click the Comments directory, you can also enter a comment if you wish.</p>
3	<p>Click OK ; a new logical network is created.</p> <p>Result: we have just created the Fipway network that appears in the project browser.</p>  <p>Note: as you can see, as small icon shows that the logical network is not associated with PLC hardware.</p>

How to access logical Fipway network configuration

The following table introduces the procedure to follow for accessing the logical Fipway network configuration:

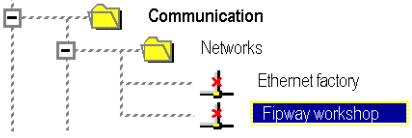
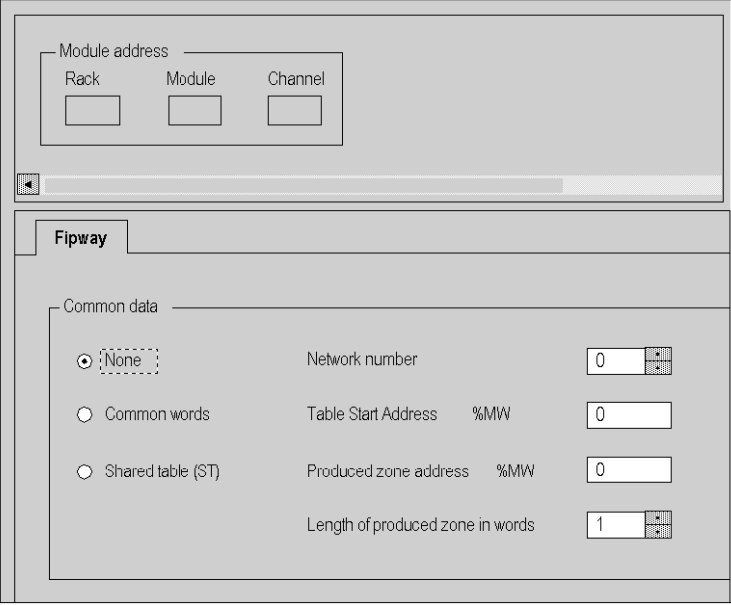
Step	Action
1	<p>Open the project browser to view your project's logical networks. Result:</p> 
2	<p>Right-click on the logical Fipway network to be configured. Result: the contextual menu appears.</p>
3	<p>Select Open in the contextual menu. Result: the Fipway configuration screen appears.</p> 

How to declare the Fipway PCMCIA card

The following table introduces the procedure to be followed to physically declare the Fipway PCMCIA card in the processor:

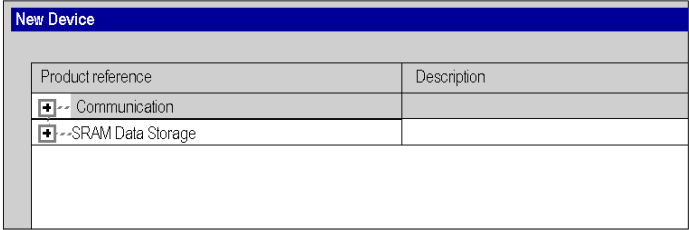
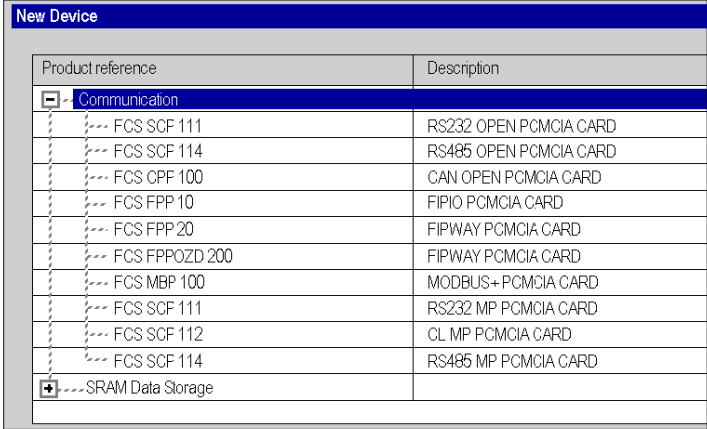
Step	Action
1	Open the hardware configuration editor.
2	<p>Double-click on the PCMCIA communication card slot (lower slot). Result: The card type selection window appears</p> 
3	<p>Develop the Communication line by clicking the + sign. Result:</p> 
4	<p>Select the Fipway TSX FPP 20 or TSX FPPOZD 200 card, and then confirm using OK. Result: the hardware configuration editor is displayed.</p>

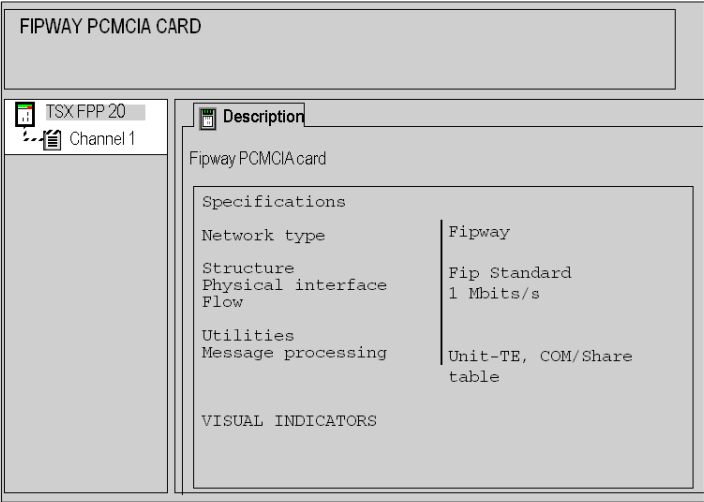
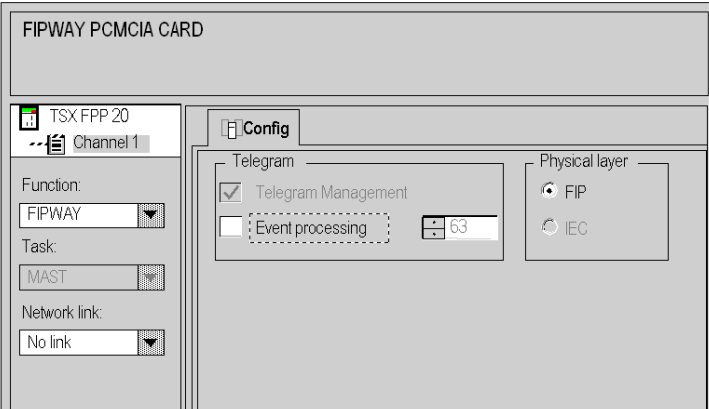
Step	Action
<p>5</p>	<p>Double-click on the processor's PCMCIA communication card. Result:</p> 
<p>6</p>	<p>Select the channel and choose the Fipway function. Result:</p> 

How to associate the logical network

The following table introduces the procedure to be followed to associate the logical Fipway network with the PCMCIA card that you have just declared:

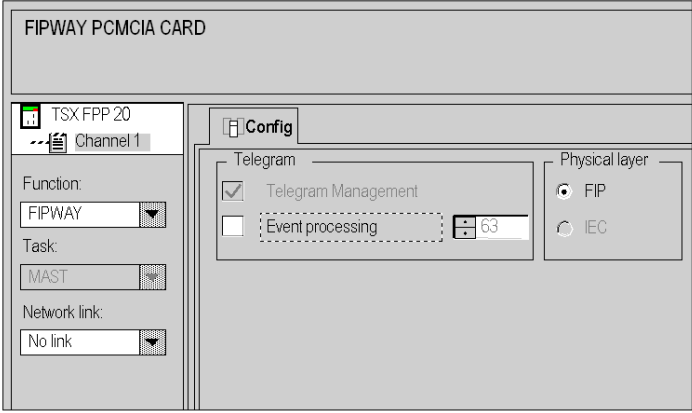
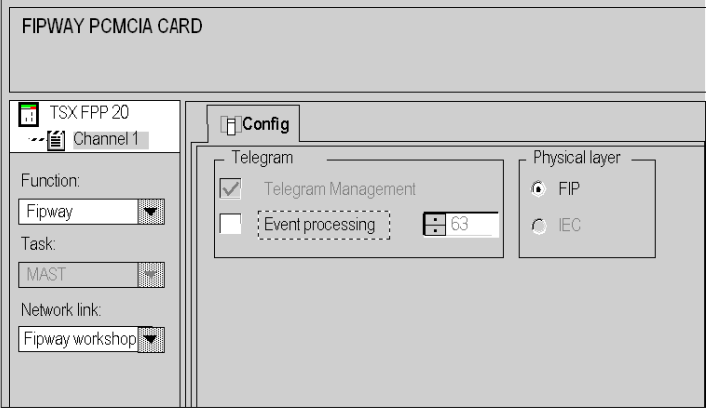
Step	Action
<p>1</p> <p>2</p>	<p>Open the hardware configuration editor.</p> <p>Click twice on the PCMCIA card slot. Result:</p> 
<p>3</p>	<p>In the Network link field, select the network to be associated with the card. Result:</p> 

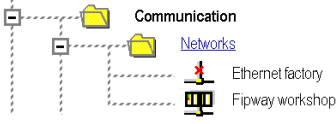
Step	Action
4	<p>Confirm your choice and close the window.</p> <p>Result: the Fipway workshop logical network is associated with the TSX FPP 20 card. The icon associated with this logical network changes and indicates the link with a PLC.</p>  <p>Also, the module address is updated in the configuration window of the Fipway workshop logical network if the window is open.</p>

Fipway configuration screen

Introduction

This screen is used to declare the communication channel and configure the parameters required for a Fipway link.

Illustration

The following diagram shows a configuration screen.

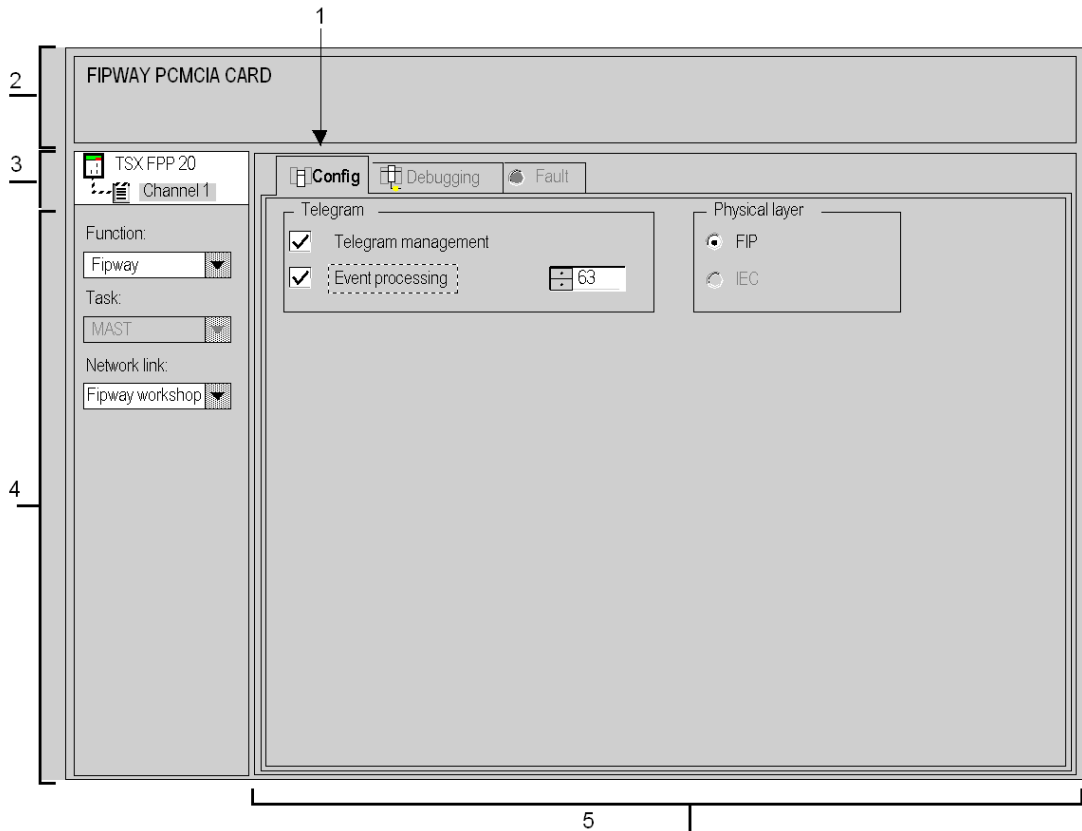

Description

The following table introduces the different elements in the configuration screen and their functions.

Address	Element	Function
1	Tabs	The tab in the foreground shows the current mode (Configuration in this example). Each mode can be selected using the corresponding tab. The modes available are: <ul style="list-style-type: none"> ● Configuration , ● Debug accessible only in online mode, ● Diagnostics (Fault) only accessible in online mode.
2	Module zone	Shows the shortened version of the module title.
3	Channel zone	Is used: <ul style="list-style-type: none"> ● By clicking on the reference number, to display the tabs: <ul style="list-style-type: none"> ○ Description which gives the characteristics of the device. ○ I/O Objects (see <i>EcoStruxure™ Control Expert, Operating Modes</i>) which is used to presymbolize the input/output objects. ○ Fault which shows the device faults (in online mode). ● To select the channel, ● To display the Symbol, name of the channel defined by the user (using the variable editor).
4	General parameters zone	Used to choose the general parameters associated with the channel: <ul style="list-style-type: none"> ● Function: for a TSX FPP 20/TSX FPPOZD 200 card, the Fipway function is the only function available. By default, No function is configured. ● Task: indicates the MAST task in which the channel's implicit exchange objects will be exchanged. This parameter is fixed.
5	configuration zone	Used to configure the channel configuration parameters. Certain filter types can be fixed and are grayed out. It is divided into two types of information: <ul style="list-style-type: none"> ● telegram management parameters (not available for Fipway cards placed on channel 1 of the TSX SCY 21601 module), ● physical layer parameters.

Fipway parameters relating to telegrams and the physical layer

Introduction

Once the communication channel has been configured, you must enter the parameters dedicated to telegrams and the physical layer.

These are divided between two windows:

- the **Telegram** window,
- the **Physical Layer** window.

Telegram Window

The window is displayed as below:



It allows you to enter:

- the **Telegram Management**: if the box is checked, the card can be used for telegram management (default setting).
- the **Event processing**: this option can be accessed only if telegram management is enabled. This option enables telegrams to be managed by event tasks. If the box is checked, you must enter the task number where the telegrams will be processed. Possible values for Premium PLCs are between 1 and 63.

NOTE: Neither of these two options are available for a TSX FPP 20 card placed on channel 1 of the TSC SCY 21601 module.

Physical layer window

The window is displayed as below:

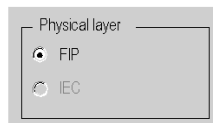

It is used to select the physical layer used for communication.

NOTE: Only the FIP-specific physical layer is available.

Fipway parameters relating to common data

Introduction

The Fipway parameters window relating to common data is accessed from the project browser (*see page 76*). The window is displayed as below:

The screenshot shows a configuration window with the following elements:

- Address module:** A sub-section containing three input fields: Chassis (0), Module (0), and Channel (1).
- Fipway:** A tabbed section with a 'Common data' sub-section.
- Common data:** A group of radio buttons and input fields:
 - None
 - Common words
 - Shared table (ST)
 - Network number: Input field with value 1.
 - Table start address %MW: Input field with value 0.
 - Created zone address %MW: Input field with value 0.
 - Length of the created zone in: Input field with value 1.

It allows you to:

- enable or disable management of common data exchanges,
- select the type of common data to exchange,
- enter the parameters required for this type of exchange.

None

Select this box if you do not want any common data to be managed in the project.

Common words

Select this box if you would like common data to be managed by common words (%NW).

When this field is selected, you must fill in the local **Network number** to which the database is linked.

NOTE: The local network number corresponds to the code number on the PCMCIA card.

Shared table

Select this box if you would like common data to be managed by shared table.

When this field is selected, you must fill in the following parameters:

- **Address at start of table:** this parameter shows the beginning of the internal word table reserved in the PLC.
The 128 words that follow the beginning of the table will be reserved for the shared table function and are shared by all the stations.
- **Address zone produced:** this parameter shows the address of the beginning of the area for internal words produced by the station.
The address that is entered must take the internal word areas for the other stations into account. Overlapping of word areas between two stations must be avoided.
- **Length of zone produced:** this parameter shows the length (in words) of the internal word table produced by the PLC (from 1 to 32 words).

Example of a shared table configuration

Introduction

The example shows how the stations are configured to use the shared table service. These configurations are based on the example given for the use of shared tables.

Configuration of station 1

The example shows the configuration for station 1.

Fipway

Common data

<input type="radio"/> None	Network number	<input style="width: 90%;" type="text" value="17"/>
<input type="radio"/> Common words	Table Start Address %MW	<input style="width: 90%;" type="text" value="200"/>
<input checked="" type="radio"/> Shared table (ST)	Produced zone address %MW	<input style="width: 90%;" type="text" value="200"/>
	Length of produced zone in words	<input style="width: 90%;" type="text" value="10"/>

Configuration of station 2

The example shows the configuration for station 2.

Fipway

Common data

<input type="radio"/> None	Network number	<input style="width: 90%;" type="text" value="17"/>
<input type="radio"/> Common words	Table Start Address %MW	<input style="width: 90%;" type="text" value="300"/>
<input checked="" type="radio"/> Shared table (ST)	Produced zone address %MW	<input style="width: 90%;" type="text" value="310"/>
	Length of produced zone in words	<input style="width: 90%;" type="text" value="20"/>

The area produced by the station begins with the address %MW310.

The area corresponding to %MW300 to %MW309 is reserved for the words produced by station 1.

Configuration of station 3

The example shows the configuration for station 3.

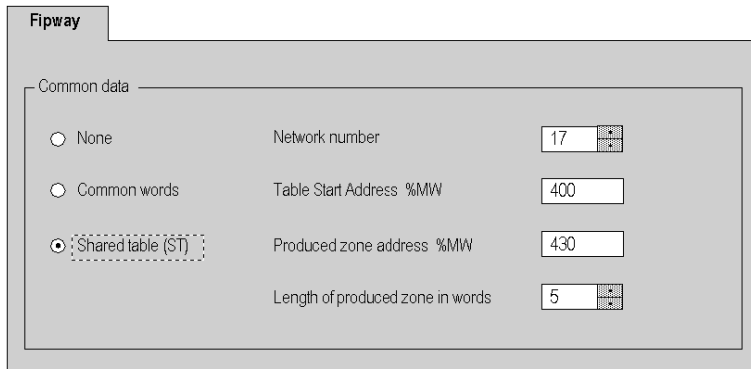

Fipway

Common data

None

Common words

Shared table (ST)

Network number: 17

Table Start Address %MW: 400

Produced zone address %MW: 430

Length of produced zone in words: 5

The area produced by the station begins with the address %MW430.

The area corresponding to %MW400 to %MW409 is reserved for the words produced by station 1.

The area corresponding to %MW410 to %MW429 is reserved for the words produced by station 2.

Chapter 8

Debugging Fipway communication

Subject of this Chapter

This Chapter describes the Debugging process during set-up of Fipway communication.

What Is in This Chapter?

This chapter contains the following topics:

Topic	Page
Fipway debug screen	90
Fipway debugging parameters	92
Requests Available for Testing a Communication Channel	94
How to Test a Channel with the Identification and Mirror Requests	95
How to Test a Channel Using Requests	97
How to access the module diagnostics and channel diagnostics functions of a Fipway device	98

Fipway debug screen

Introduction

This screen, split into two zones, allows you to debug a Fipway link.

Illustration

The figure below shows an example of a debug screen dedicated to Fipway communication.

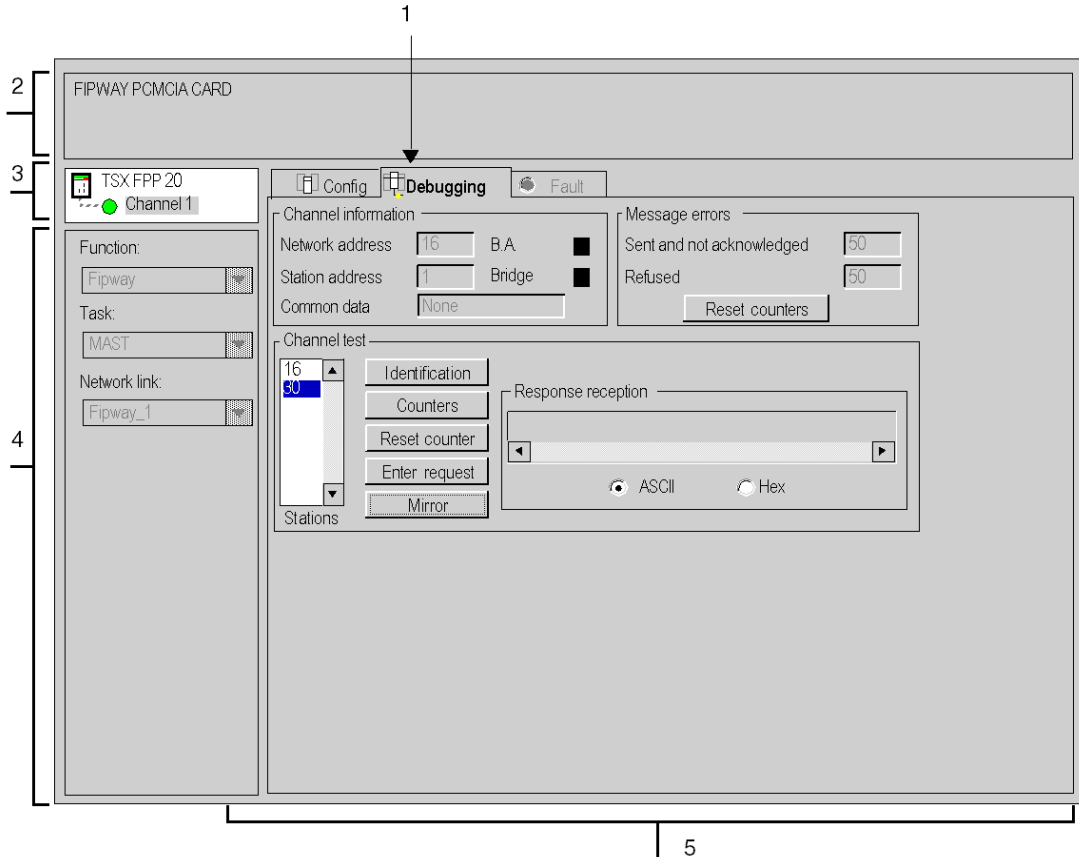

Description

The table below shows the various elements of the debug screen and their functions.

Address	Element	Function
1	Tabs	The tab in the foreground shows the current mode (Debug in this example). Each mode can be selected using the corresponding tab. The modes available are: <ul style="list-style-type: none"> ● Debug accessible only in online mode, ● Diagnostic (Fault), only accessible in online mode, ● Configuration.
2	Module zone	Shows the shortened version of the module title.
3	Channel zone	Is used: <ul style="list-style-type: none"> ● By clicking on the reference number, to display the tabs: <ul style="list-style-type: none"> ○ Description which gives the characteristics of the device. ○ I/O Objects (<i>see EcoStruxure™ Control Expert, Operating Modes</i>) which is used to presymbolize the input/output objects. ○ Fault which shows the device faults (in online mode). ● To select the channel, ● To display the Symbol, name of the channel defined by the user (using the variable editor).
4	General parameters zone	Specifies the parameters of the communication channel: <ul style="list-style-type: none"> ● Function: specifies the communication function configured. This heading is frozen. ● Task: specifies the MAST task configured. This heading is frozen. ● Network link: specifies the Fipway logical network (<i>see page 79</i>) associated with the card. This heading is frozen.
5	Display and command zone	is used to access the debugging parameters of a Fipway link. It is split into three windows: <ul style="list-style-type: none"> ● channel information, ● information on message errors, ● the possibility of testing the communication channel.

NOTE: LEDs and commands not available appear grayed out.

Fipway debugging parameters

At a Glance

The specific part is split into three windows:

- The **Channel information** window,
- The **Message errors** window,
- The **Channel test** window.

Channel information

The window is displayed as shown below:

Channel			
Network address	23	B.A.	<input type="checkbox"/>
Station address	8	Bridge	<input checked="" type="checkbox"/>
Common data	Common		

It contains information concerning the communication channel:

- **Network address:** this field indicates the network address encoded on the PCMCIA card.
- **Station address:** this field indicates the station address encoded on the PCMCIA card.
- **Common data:** this field specifies the type of common data selected in configuration mode.
- **B.A.:** this field indicates if the local PCMCIA card is the bus arbiter of the Fipway network. In this case, the box is blacked out.
- **Router:** this field indicates if the local PCMCIA card is configured as a Bridge (router). In this case, the box is blacked out.

Message errors

The window is displayed as shown below:

Message errors	
Sent and not acknowledged	0
Refused	0
Reset Counters	

This window displays the error counters of the PCMCIA card:

- **Messages sent and not acknowledged,**
- **Messages refused.**

The **Reset counters** button resets these counters to zero.

Channel test

The window is displayed as shown below:

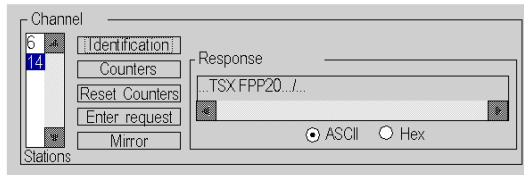

This window is used to test a communication channel by sending a request to one of the stations present on the network.

Requests Available for Testing a Communication Channel

At a Glance

This page describes the various options for testing a communication channel from the debug screen.

Test conditions

Sending a request to a station that is not connected results in an error message.

Requests available

The Channel test window offers the following requests:

- **Identification:** causes the Identification request to be sent to the designated slave,
- **Counters:** causes the Read error counters request to be sent to the designated station. The message received is composed firstly of the number of messages sent but not acknowledged followed by the number of refused messages.
- **Reset Counters:** causes the error counters of the designated station to be reset to zero,
- **Enter Request:** is used to send a UNI-TE request, other than those provided by the command buttons, to the designated station. If this function is chosen, a screen appears allowing you to select the parameters specific to the request (the request code must be encoded in hexadecimal),
- **Mirror:** is used to send a Mirror request to the designated station. If this function is chosen, a screen appears allowing you to select the length of the string of characters to be sent (maximum of 80 characters). The PLC then sends this string of characters (ABCD, etc.) to the destination device. The destination device automatically returns the character string received to the sender.

How to Test a Channel with the Identification and Mirror Requests

At a Glance

This page describes the procedure for testing a communication channel using the Identification and Mirror requests.

How to identify a station

The following procedure is used to identify a designated station.

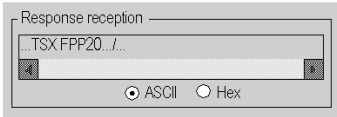
Step	Actions
1	Select the address of the station to be queried using the Station field.
2	Press the Identification button. Result: the response appears in the Receive Response window. 

How to send the Mirror request

The following procedure is used to send the Mirror request and therefore to test the correct routing of information between two devices.

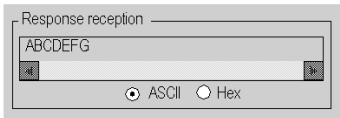
Step	Action
1	Select the address of the station to be queried using the Station field.
2	<p>Press the Mirror button.</p> <p>Result: the following window appears.</p> 
3	Enter the length of the data to be sent (maximum 80 characters).
4	<p>Press the Send button.</p> <p>Result: the response appears in the Receive Response window.</p>  <p>The response contains:</p> <ul style="list-style-type: none"> the character string ABCDEFGH corresponding to a length of data sent of 8.

How to Test a Channel Using Requests

At a Glance

This page describes the procedure for testing a communication channel from the debug screen using various requests.

How to send a request

The following procedure is used to send a request, other than those provided by the command buttons, to a designated station.

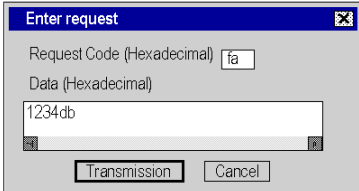
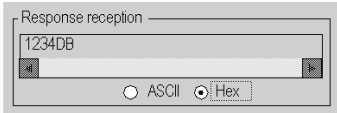
Step	Action
1	Select the address of the station to be queried using the Station field.
2	<p>Press the Enter Request button. Result: the following window appears.</p>  <p>The data sent in this example are encoded on 3 bytes.</p>
3	Enter the function code (encoded in hexadecimal on one byte) corresponding to the request that you wish to send.
4	Enter the data to be sent by encoding each data item in hexadecimal. The data are entered one after another without any space between them.
5	<p>Press the Send button. Result: the response appears in the Receive Response window.</p>  <p>The response in this example contains the data on 3 bytes (12 34 DB).</p>

How to access the module diagnostics and channel diagnostics functions of a Fipway device

Introduction

The module or channel diagnostics functions display current faults (when they exist) classed according to their category:

- internal faults (software internal fault, communication fault with the processor, configuration/parameterization error),
- external faults (faulty slave device, difference between physical configuration and Control Expert configuration),
- other faults (module missing or off).

A faulty module or channel is indicated by certain LEDs turning red such as:

- in the rack configuration screen, by the presence of a red square in the position of the faulty counting module,
- in all the module level screens (**Description** and **Fault** tabs),
 - in the module zone with the **I/O** LED.
- in all the channel level screens (**Description**, **Debug** and **Fault** tabs),
 - in the module zone with the **I/O** LED,
 - in the channel field with the channel fault LED.
- in the faulty screen accessible with the **Fault** tab where the fault diagnostics are described.

The fault is also signaled:

- on the module, through the centralized display,
- by the dedicated language objects: **CH_ERROR** (%lr.m.c.ERR) and module error **MOD_ERROR** (%lr.m.MOD.ERR), **%MWr.m.MOD.2**, etc., and the status words (*see page 124*).

Procedure for accessing diagnostics

The table below shows the procedure for accessing the **Fault** screen of the module and the Fipway channel.

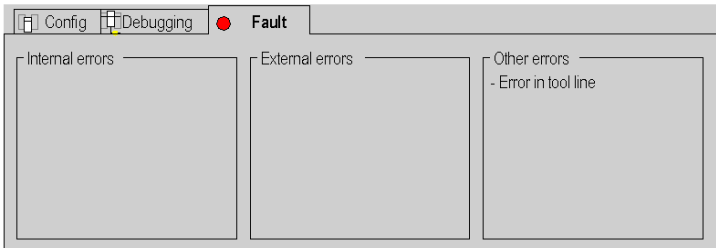
Step	Action
1	Open the Fipway module to be diagnosed.
2	Access the diagnostics screen by clicking on the Fault tab. Result: The list of module faults appears. 

Chapter 9

Fipway communication language objects

Subject of this Chapter

This chapter describes the language objects associated with Fipway communication as well as the various ways in which they may be used.

What Is in This Chapter?

This chapter contains the following sections:

Section	Topic	Page
9.1	Fipway communication language objects and IODDTs	102
9.2	Language Objects and Generic IODDT Applicable to Communication Protocols	111
9.3	Language objects and IODDTs associated with Fipway communication	115
9.4	The IODDT Type T_GEN_MOD Applicable to All Modules	124

Section 9.1

Fipway communication language objects and IODDTs

Subject of this Section

This section provides general information on Fipway communication language objects and IODDTs.

What Is in This Section?

This section contains the following topics:

Topic	Page
Introduction to Fipway communication language objects	103
Implicit Exchange Language Objects Associated with the Application-Specific Function	104
Explicit Exchange Language Objects Associated with the Application-Specific Function	105
Management of Exchanges and Reports with Explicit Objects	107

Introduction to Fipway communication language objects

General

The IODDTs are predefined by the manufacturer; they contain input/output language objects for an application-specific channel. Fipway communication has two associated IODDTs:

- `T_COM_STS_GEN` which applies to all communication protocols except Fipio and Ethernet,
- `T_COM_FPW` specific to Fipway communication.

NOTE: IODDT variables can be created in two different ways:

- Using the **I/O objects** (see *EcoStruxure™ Control Expert, Operating Modes*) tab,
- Data Editor (see *EcoStruxure™ Control Expert, Operating Modes*).

Language objects types

Each IODDT contains a group of language objects used to control and verify IODDTs and their operations.

There are two types of language objects:

- **implicit exchange objects**, which are automatically exchanged on each new cycle of the task associated with the module,
- **explicit exchange objects**, which are exchanged at the request of the application, via explicit exchange instructions.

Implicit exchanges concern module states and communication signals.

Explicit exchanges are used to set parameters for the module and perform diagnostics.

Implicit Exchange Language Objects Associated with the Application-Specific Function

At a Glance

An integrated application-specific interface or the addition of a module automatically enhances the language objects application used to program this interface or module.

These objects correspond to the input/output images and software data of the module or integrated application-specific interface.

Reminders

The module inputs (%I and %IW) are updated in the PLC memory at the start of the task, the PLC being in RUN or STOP mode.

The outputs (%Q and %QW) are updated at the end of the task, only when the PLC is in RUN mode.

NOTE: When the task occurs in STOP mode, either of the following are possible, depending on the configuration selected:

- outputs are set to fallback position (fallback mode)
- outputs are maintained at their last value (maintain mode)

Figure

The following diagram shows the operating cycle of a PLC task (cyclical execution).

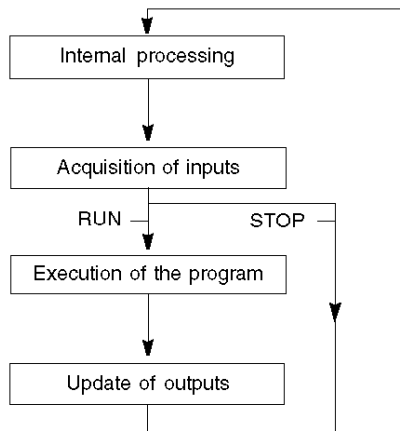

Explicit Exchange Language Objects Associated with the Application-Specific Function

Introduction

Explicit exchanges are performed at the user program's request using these instructions:

- READ_STS (read status words)
- WRITE_CMD (write command words)
- WRITE_PARAM (write adjustment parameters)
- READ_PARAM (read adjustment parameters)
- SAVE_PARAM (save adjustment parameters)
- RESTORE_PARAM (restore adjustment parameters)

For more details about instructions, refer to *EcoStruxure™ Control Expert, I/O Management, Block Library*.

These exchanges apply to a set of %MW objects of the same type (status, commands or parameters) that belong to a channel.

These objects can:

- provide information about the module (for example, type of error detected in a channel)
- have command control of the module (for example, switch command)
- define the module's operating modes (save and restore adjustment parameters in the process of application)

NOTE: To avoid several simultaneous explicit exchanges for the same channel, it is necessary to test the value of the word EXCH_STS (%MW_{r.m.c.0}) of the IODDT associated to the channel before calling any EF addressing this channel.

NOTE: Explicit exchanges are not supported when X80 analog and digital I/O modules are configured through an eX80 adapter module (BMECRA31210) in a Quantum EIO configuration. You cannot set up a module's parameters from the PLC application during operation.

General Principle for Using Explicit Instructions

The diagram below shows the different types of explicit exchanges that can be made between the application and module.

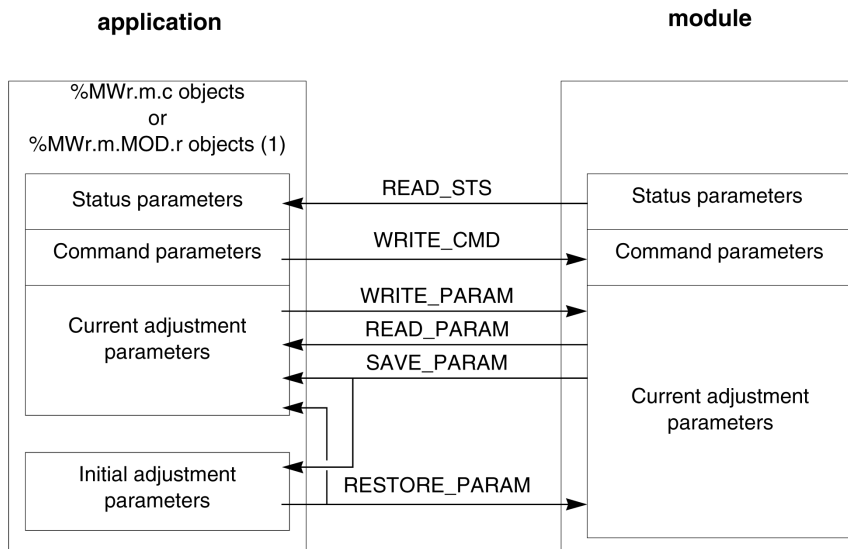

(1) Only with READ_STS and WRITE_CMD instructions.

Managing Exchanges

During an explicit exchange, check performance to see that the data is only taken into account when the exchange has been correctly executed.

To do this, two types of information is available:

- information concerning the exchange in progress (*see page 110*)
- the exchange report (*see page 110*)

The following diagram describes the management principle for an exchange.

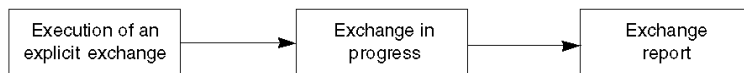

NOTE: In order to avoid several simultaneous explicit exchanges for the same channel, it is necessary to test the value of the word EXCH_STS (%MWr.m.c.0) of the IODDT associated to the channel before calling any EF addressing this channel.

Management of Exchanges and Reports with Explicit Objects

At a Glance

When data is exchanged between the PLC memory and the module, the module may require several task cycles to acknowledge this information. IODDTs use two words to manage exchanges:

- EXCH_STS (%MW_{r.m.c.0}): exchange in progress
- EXCH_RPT (%MW_{r.m.c.1}): report

NOTE:

Depending on the localization of the module, the management of the explicit exchanges (%MW0.0.MOD.0.0 for example) will not be detected by the application:

- For in-rack modules, explicit exchanges are done immediately on the local PLC Bus and are finished before the end of the execution task. So, the READ_STS, for example, is finished when the %MW0.0.mod.0.0 bit is checked by the application.
- For remote bus (Fipio for example), explicit exchanges are not synchronous with the execution task, so the detection is possible by the application.

Illustration

The illustration below shows the different significant bits for managing exchanges:

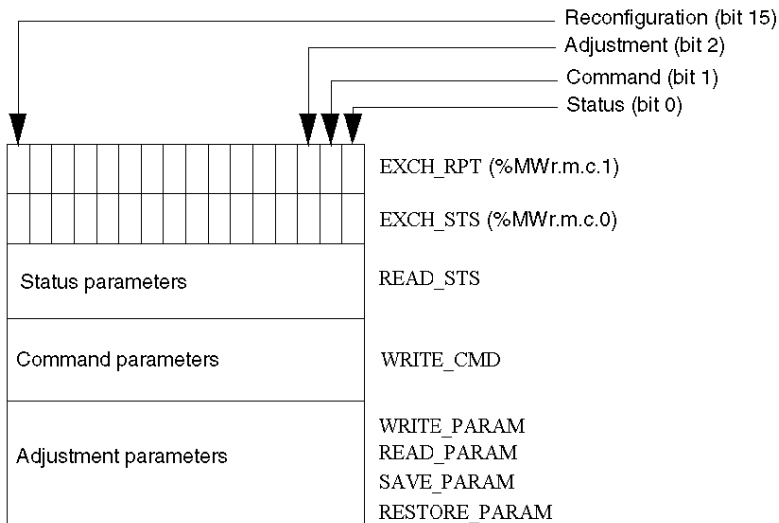

Description of Significant Bits

Each bit of the words `EXCH_STS` (`%MWr.m.c.0`) and `EXCH_RPT` (`%MWr.m.c.1`) is associated with a type of parameter:

- Rank 0 bits are associated with the status parameters:
 - The `STS_IN_PROGR` bit (`%MWr.m.c.0.0`) indicates whether a read request for the status words is in progress.
 - The `STS_ERR` bit (`%MWr.m.c.1.0`) specifies whether a read request for the status words is accepted by the module channel.
- Rank 1 bits are associated with the command parameters:
 - The `CMD_IN_PROGR` bit (`%MWr.m.c.0.1`) indicates whether command parameters are being sent to the module channel.
 - The `CMD_ERR` bit (`%MWr.m.c.1.1`) specifies whether the command parameters are accepted by the module channel.
- Rank 2 bits are associated with the adjustment parameters:
 - The `ADJ_IN_PROGR` bit (`%MWr.m.c.0.2`) indicates whether the adjustment parameters are being exchanged with the module channel (via `WRITE_PARAM`, `READ_PARAM`, `SAVE_PARAM`, `RESTORE_PARAM`).
 - The `ADJ_ERR` bit (`%MWr.m.c.1.2`) specifies whether the adjustment parameters are accepted by the module. If the exchange is correctly executed, the bit is set to 0.
- Rank 15 bits indicate a reconfiguration on channel **c** of the module from the console (modification of the configuration parameters + cold start-up of the channel).
- The *r*, *m* and *c* bits indicates the following elements:
 - the **r** bit represents the rack number.
 - The **m** bit represents the position of the module in the rack.
 - The **c** bit represents the channel number in the module.

NOTE: **r** represents the rack number, **m** the position of the module in the rack, while **c** represents the channel number in the module.

NOTE: Exchange and report words also exist at module level `EXCH_STS` (`%MWr.m.MOD`) and `EXCH_RPT` (`%MWr.m.MOD.1`) as per IODDT type `T_GEN_MOD`.

Example

Phase 1: Sending data by using the `WRITE_PARAM` instruction

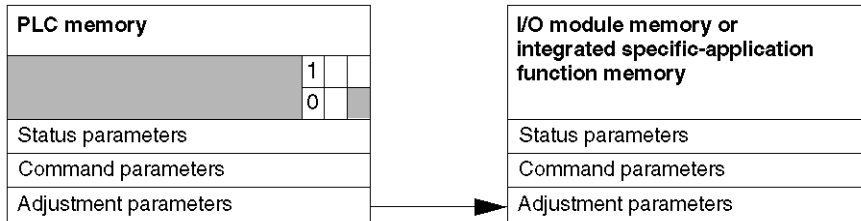

When the instruction is scanned by the PLC, the **Exchange in progress** bit is set to 1 in `%MWr.m.c`.

Phase 2: Analysis of the data by the I/O module and report.

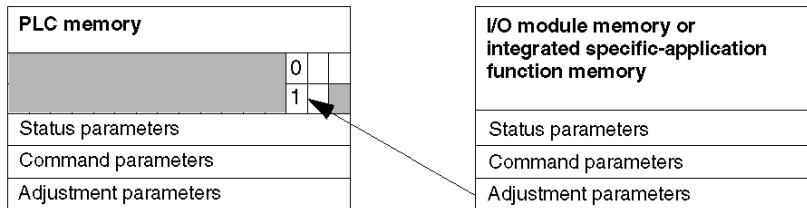

When the data is exchanged between the PLC memory and the module, acknowledgement by the module is managed by the `ADJ_ERR` bit (`%MWr.m.c.1.2`).

This bit makes the following reports:

- 0: correct exchange
- 1: incorrect exchange)

NOTE: There is no adjustment parameter at module level.

Execution Indicators for an Explicit Exchange: EXCH_STS

The table below shows the control bits of the explicit exchanges: EXCH_STS (%MWr.m.c.0)

Standard Symbol	Type	Access	Meaning	Address
STS_IN_PROGR	BOOL	R	Reading of channel status words in progress	%MWr.m.c.0.0
CMD_IN_PROGR	BOOL	R	Command parameters exchange in progress	%MWr.m.c.0.1
ADJ_IN_PROGR	BOOL	R	Adjust parameters exchange in progress	%MWr.m.c.0.2
RECONF_IN_PROGR	BOOL	R	Reconfiguration of the module in progress	%MWr.m.c.0.15

NOTE: If the module is not present or is disconnected, explicit exchange objects (READ_STS for example) are not sent to the module (STS_IN_PROG (%MWr.m.c.0.0) = 0), but the words are refreshed.

Explicit Exchange Report: EXCH_RPT

The table below shows the report bits: EXCH_RPT (%MWr.m.c.1)

Standard Symbol	Type	Access	Meaning	Address
STS_ERR	BOOL	R	Error detected while reading channel status words (1 = detected error)	%MWr.m.c.1.0
CMD_ERR	BOOL	R	Error detected during a command parameter exchange (1 = detected error)	%MWr.m.c.1.1
ADJ_ERR	BOOL	R	Error detected during an adjust parameter exchange (1 = detected error)	%MWr.m.c.1.2
RECONF_ERR	BOOL	R	Error detected during reconfiguration of the channel (1 = detected error)	%MWr.m.c.1.15

Counting Module Use

The following table describes the steps realized between a counting module and the system after a power-on.

Step	Action
1	Power on.
2	The system sends the configuration parameters.
3	The system sends the adjust parameters by WRITE_PARAM method. Note: When the operation is finished, the bit %MWr.m.c.0.2 switches to 0.

If, in the beginning of your application, you use a WRITE_PARAM command, wait until the bit %MWr.m.c.0.2 switches to 0.

Section 9.2

Language Objects and Generic IODDT Applicable to Communication Protocols

About this Section

This section presents the language objects and generic IODDT applicable to all communication protocols except Fipio and Ethernet.

What Is in This Section?

This section contains the following topics:

Topic	Page
Details of IODDT Implicit Exchange Objects of Type T_COM_STS_GEN	112
Details of IODDT Explicit Exchange Objects of Type T_COM_STS_GEN	113

Details of IODDT Implicit Exchange Objects of Type T_COM_STS_GEN

Introduction

The following table presents the IODDT implicit exchange objects of type T_COM_STS_GEN applicable to all communication protocols except Fipio and Ethernet.

Error Bit

The table below presents the meaning of the detected error bit CH_ERROR (%Ir.m.c.ERR).

Standard Symbol	Type	Access	Meaning	Address
CH_ERROR	EBOOL	R	Communication channel error bit.	%Ir.m.c.ERR

Details of IODDT Explicit Exchange Objects of Type T_COM_STS_GEN

Introduction

This section presents the T_COM_STS_GEN type IODDT explicit exchange objects applicable to all communication protocols except Fipio and Ethernet. It includes the word type objects whose bits have a specific meaning. These objects are presented in detail below.

Sample Variable Declaration: IODDT_VAR1 of type T_COM_STS_GEN

Observations

- In general, the meaning of the bits is given for bit status 1. In specific cases an explanation is given for each status of the bit.
- Not all bits are used.

Execution Flags of an Explicit Exchange: EXCH_STS

The table below shows the meaning of channel exchange control bits from channel EXCH_STS (%MWr.m.c.0).

Standard Symbol	Type	Access	Meaning	Address
STS_IN_PROGR	BOOL	R	Reading of channel status words in progress.	%MWr.m.c.0.0
CMD_IN_PROGR	BOOL	R	Current parameter exchange in progress.	%MWr.m.c.0.1
ADJ_IN_PROGR	BOOL	R	Adjustment parameter exchange in progress.	%MWr.m.c.0.2

Explicit Exchange Report: EXCH_RPT

The table below presents the meaning of the exchange report bits EXCH_RPT (%MWr.m.c.1).

Standard Symbol	Type	Access	Meaning	Address
STS_ERR	BOOL	R	Reading error for channel status words.	%MWr.m.c.1.0
CMD_ERR	BOOL	R	Error during command parameter exchange.	%MWr.m.c.1.1
ADJ_ERR	BOOL	R	Error during adjustment parameter exchange.	%MWr.m.c.1.2

Standard Channel Faults, CH_FLT

The table below shows the meaning of the bits of the status word CH_FLT (%MWr.m.c.2). Reading is performed by a READ_STS (IODDT_VAR1).

Standard Symbol	Type	Access	Meaning	Address
NO_DEVICE	BOOL	R	No device is working on the channel.	%MWr.m.c.2.0
1_DEVICE_FLT	BOOL	R	A device on the channel is inoperative.	%MWr.m.c.2.1
BLK	BOOL	R	Terminal block not connected.	%MWr.m.c.2.2
TO_ERR	BOOL	R	Time out exceeded anomaly.	%MWr.m.c.2.3
INTERNAL_FLT	BOOL	R	Internal detected error or channel self-testing.	%MWr.m.c.2.4
CONF_FLT	BOOL	R	Different hardware and software configurations.	%MWr.m.c.2.5
COM_FLT	BOOL	R	Interruption of the communication with the PLC.	%MWr.m.c.2.6
APPLI_FLT	BOOL	R	Application detected error (adjustment or configuration).	%MWr.m.c.2.7

Section 9.3

Language objects and IODDTs associated with Fipway communication

Subject of this Section

This section introduces language objects and IODDTs that are associated with Fipway communication.

What Is in This Section?

This section contains the following topics:

Topic	Page
Details of the implicit exchange objects of the T_COM_FPW IODDT	116
Details of the Explicit Exchange Objects of the T_COM_FPW IODDT	119
Language Objects Associated with Configuration	122
Details of the Explicit Exchange Objects for a Fipway Function	123

Details of the implicit exchange objects of the T_COM_FPW IODDT

At a Glance

The following tables introduce the implicit exchange objects of the T_COM_FPW IODDT which apply to Fipway communication.

Error bit

The following table explains the meaning of the error bit CH_ERROR (%I.r.m.c.ERR).

Standard symbol	Type	Access	Meaning	Address
CH_ERROR	EBOOL	R	Communication channel error bit.	%I.r.m.c.ERR

Status bit

The following table explains the meaning of the status bit NET_STS (%IW.r.m.c.0.0).

Standard symbol	Type	Access	Meaning	Address
NET_STS	BOOL	R	Presence bit for at least one of the stations.	%IW.r.m.c.0.0

Output signals object

The following table explains the meaning of the status bit STOP_EXCH (%QWr.m.c.0.0).

Standard symbol	Type	Access	Meaning	Address
STOP_EXCH	BOOL	R	Rising edge at 1: stop of all current exchanges.	%QWr.m.c.0.0

Update flags

The following table explains the meanings of the word bits which serve as update flags of common data for stations 0 to 15.

Standard symbol	Type	Access	Meaning	Address
REFRESH_ID_0	BOOL	R	The common words or words in the shared table for station 0 are updated.	%IW.r.m.c.1.0
REFRESH_ID_1	BOOL	R	The common words or words in the shared table for station 1 are updated.	%IW.r.m.c.1.1
REFRESH_ID_2	BOOL	R	The common words or words in the shared table for station 2 are updated.	%IW.r.m.c.1.2
REFRESH_ID_3	BOOL	R	The common words or words in the shared table for station 3 are updated.	%IW.r.m.c.1.3
REFRESH_ID_4	BOOL	R	The common words or words in the shared table for station 4 are updated.	%IW.r.m.c.1.4
REFRESH_ID_5	BOOL	R	The common words or words in the shared table for station 5 are updated.	%IW.r.m.c.1.5
REFRESH_ID_6	BOOL	R	The common words or words in the shared table for station 6 are updated.	%IW.r.m.c.1.6
REFRESH_ID_7	BOOL	R	The common words or words in the shared table for station 7 are updated.	%IW.r.m.c.1.7
REFRESH_ID_8	BOOL	R	The common words or words in the shared table for station 8 are updated.	%IW.r.m.c.1.8
REFRESH_ID_9	BOOL	R	The common words or words in the shared table for station 9 are updated.	%IW.r.m.c.1.9
REFRESH_ID_10	BOOL	R	The common words or words in the shared table for station 10 are updated.	%IW.r.m.c.1.10
REFRESH_ID_11	BOOL	R	The common words or words in the shared table for station 11 are updated.	%IW.r.m.c.1.11
REFRESH_ID_12	BOOL	R	The common words or words in the shared table for station 12 are updated.	%IW.r.m.c.1.12
REFRESH_ID_13	BOOL	R	The common words or words in the shared table for station 13 are updated.	%IW.r.m.c.1.13
REFRESH_ID_14	BOOL	R	The common words or words in the shared table for station 14 are updated.	%IW.r.m.c.1.14
REFRESH_ID_15	BOOL	R	The common words or words in the shared table for station 15 are updated.	%IW.r.m.c.1.15

Update flags

The following table introduces word bit meanings, update flags of common data for stations 16 to 31.

Standard symbol	Type	Access	Meaning	Address
REFRESH_ID_16	BOOL	R	The common words or words in the shared table for station 16 are updated.	%IW.r.m.c.2.0
REFRESH_ID_17	BOOL	R	The common words or words in the shared table for station 17 are updated.	%IW.r.m.c.2.1
REFRESH_ID_i	BOOL	R	The common words or words in the shared table for station i are updated.	%IW.r.m.c.2.n
REFRESH_ID_31	BOOL	R	The common words or words in the shared table for station 31 are updated.	%IW.r.m.c.2.15

Update flags

The following table for stations 32 to 47 is not significant for common words or words in the shared table.

Standard symbol	Type	Access	Meaning	Address
REFRESH_ID_32	BOOL	R	The common words or words in the shared table for station 32 are updated.	%IW.r.m.c.3.0
REFRESH_ID_33	BOOL	R	The common words or words in the shared table for station 33 are updated.	%IW.r.m.c.3.1
REFRESH_ID_i	BOOL	R	The common words or words in the shared table for station i are updated.	%IW.r.m.c.3.n
REFRESH_ID_47	BOOL	R	The common words or words in the shared table for station 47 are updated.	%IW.r.m.c.3.15

Update flags

The following table for stations 48 to 63 is not significant for common words or words in the shared table.

Standard symbol	Type	Access	Meaning	Address
REFRESH_ID_48	BOOL	R	The common words or words in the shared table for station 48 are updated.	%IW.r.m.c.4.0
REFRESH_ID_49	BOOL	R	The common words or words in the shared table for station 49 are updated.	%IW.r.m.c.4.1
REFRESH_ID_i	BOOL	R	The common words or words in the shared table for station i are updated.	%IW.r.m.c.4.n
REFRESH_ID_63	BOOL	R	The common words or words in the shared table for station 63 are updated.	%IW.r.m.c.4.15

Details of the Explicit Exchange Objects of the T_COM_FPW IODDT

At a Glance

The following tables introduce the explicit exchange objects of the T_COM_FPW IODDT which apply to Fipway communication. It covers word-type objects, whose bits have a particular meaning. These objects are introduced in detail below.

Example of a declaration for a variable: **IODDT_VAR1** of the type T_COM_FPW

Notes

- The meaning of bits is usually given for status 1 of this bit. In specific cases, each bit status is explained.
- All bits are not used.

Explicit Exchange Execution Flags: EXCH_STS

The following table explains the meanings of the channel exchange control bits EXCH_STS (%MWr.m.c.0).

Standard symbol	Type	Access	Meaning	Address
STS_IN_PROGR	BOOL	R	Reading of the status words of the channel in progress.	%MWr.m.c.0.0
CMD_IN_PROGR	BOOL	R	Command parameters exchange in progress.	%MWr.m.c.0.1
ADJ_IN_PROGR	BOOL	R	Adjust parameters exchange in progress.	%MWr.m.c.0.2

Explicit Exchange Report: EXCH_RPT

The following table introduces the meanings of report bits EXCH_RPT (%MWr.m.c.1).

Standard symbol	Type	Access	Meaning	Address
STS_ERR	BOOL	R	Channel status words read fault.	%MWr.m.c.1.0
CMD_ERR	BOOL	R	Fault during exchange of command parameters.	%MWr.m.c.1.1
ADJ_ERR	BOOL	R	Fault during exchange of adjustment parameters.	%MWr.m.c.1.2

Standard Channel Faults, CH_FLT

The following table introduces the meanings of the status words bits CH_FLT (%MWr.m.c.2); reading is carried out by a READ_STS (IODDT_VAR1).

Standard symbol	Type	Access	Meaning	Address
NO_DEVICE	BOOL	R	No device is functioning on the channel.	%MWr.m.c.2.0
1_DEVICE_FLT	BOOL	R	A device on the channel is faulty.	%MWr.m.c.2.1
BLK	BOOL	R	Terminal block fault (not connected).	%MWr.m.c.2.2
TO_ERR	BOOL	R	Time Out error (faulty wiring).	%MWr.m.c.2.3
INTERNAL_FLT	BOOL	R	Internal error or channel self-test.	%MWr.m.c.2.4
CONF_FLT	BOOL	R	Different hardware and software configurations.	%MWr.m.c.2.5
COM_FLT	BOOL	R	Problem communicating with the PLC.	%MWr.m.c.2.6
APPLI_FLT	BOOL	R	Application fault (double address station, adjustment or configuration fault).	%MWr.m.c.2.7

Station status

The following table explains the meanings of the status word bits for stations 0 to 15; reading is carried out by a READ_STS (IODDT_VAR1).

Standard symbol	Type	Access	Meaning	Address
STA_STS_0	BOOL	R	Presence of station 0.	%MWr.m.c.8.0
STA_STS_1	BOOL	R	Presence of station 1.	%MWr.m.c.8.1
STA_STS_n	BOOL	R	Presence of station n.	%MWr.m.c.8.n
STA_STS_15	BOOL	R	Presence of station 15.	%MWr.m.c.8.15

Station status

The following table explains the meanings of the status word bits for stations 16 to 31; reading is carried out by a READ_STS (IODDT_VAR1).

Standard symbol	Type	Access	Meaning	Address
STA_STS_16	BOOL	R	Presence of station 16.	%MWr.m.c.9.0
STA_STS_17	BOOL	R	Presence of station 17.	%MWr.m.c.9.1
STA_STS_n	BOOL	R	Presence of station n.	%MWr.m.c.9.i
STA_STS_31	BOOL	R	Presence of station 31.	%MWr.m.c.9.15

Station status

The following table explains the meanings of the status word bits for stations 32 to 47; reading is carried out by a **READ_STS (IODDT_VAR1)**.

Standard symbol	Type	Access	Meaning	Address
STA_STS_32	BOOL	R	Presence of station 32.	%MWr.m.c.10.0
STA_STS_33	BOOL	R	Presence of station 33.	%MWr.m.c.10.1
STA_STS_n	BOOL	R	Presence of station n.	%MWr.m.c.10.i
STA_STS_47	BOOL	R	Presence of station 47.	%MWr.m.c.10.15

Station status

The following table explains the meanings of the status word bits for stations 48 to 63; reading is carried out by a **READ_STS (IODDT_VAR1)**.

Standard symbol	Type	Access	Meaning	Address
STA_STS_48	BOOL	R	Presence of station 48.	%MWr.m.c.11.0
STA_STS_49	BOOL	R	Presence of station 49.	%MWr.m.c.11.1
STA_STS_n	BOOL	R	Presence of station n.	%MWr.m.c.11.i
STA_STS_63	BOOL	R	Presence of station 63.	%MWr.m.c.11.15

Language Objects Associated with Configuration

At a Glance

This page describes all the configuration language objects for Fipway communication. These objects are not integrated into the IODDTs; they can be displayed by the application program.

Internal Constants

The following table describes the internal constants:

Object	Type	Access	Meaning
%KWr.m.c.0	INT	R	Byte 0 = 4 for Fipway communication
%KWr.m.c.1	INT	R	Byte 0 : station address <ul style="list-style-type: none"> ● = 0: FIP physical layer, ● = 1: WOLRD FIP physical layer. Byte 1 : event number configured, (= -1 if " event processing " is not checked in the configuration screen)
%KWr.m.c.2	INT	R	Byte 0: common data <ul style="list-style-type: none"> ● = 16#00: none, ● = 16#01: common words ● = 16#02: shared table Byte 1: telegrams (only valid for FPP20 in channel 1 of processor) <ul style="list-style-type: none"> ● = 16#00: not supported, ● = 16#01: supported.
%KWr.m.c.3	INT	R	Address of the beginning of the shared table.
%KWr.m.c.4	INT	R	Byte 0: number of common words or size of the shared table production area. Byte 1: Address (in bytes) of the beginning of the shared table production area.

Details of the Explicit Exchange Objects for a Fipway Function

At a Glance

The following tables introduce the language objects for Fipway communication. These objects are not integrated into the IODDTs.

List of Explicit Exchange Objects

The table below shows explicit exchange objects.

Number	Type	Access	Meaning
%MWr.m.c.3	INT	R	Byte 0: <ul style="list-style-type: none"> ● bit 0 = 0: if bridge, not router. Byte 1: <ul style="list-style-type: none"> ● = 16#00: bus master function not supported, ● = 16#03: bus master function active, ● = 16#20: bus master function on standby.
%MWr.m.c.4	INT	R	Messages not acknowledged.
%MWr.m.c.5	INT	R	Messages refused.
%MWr.m.c.6	INT	R	Byte 0: station number. Byte 1: network number.
%MWr.m.c.7	INT	R	Byte 0: <ul style="list-style-type: none"> ● 16#00: service inactive, ● 16#01: common words read/write, ● 16#02: common words read, ● 16#03: participation in the exchange of a shared table (operation without error), ● 16#04: overlapping of a shared table exchange area, ● 16#05: exchange error for a shared table. Byte 1: size.

Section 9.4

The IODDT Type T_GEN_MOD Applicable to All Modules

Details of the Language Objects of the T_GEN_MOD-Type IODDT

Introduction

Modules of Premium PLCs have an associated IODDT of type T_GEN_MOD.

Observations

- In general, the meaning of the bits is given for bit status 1. In specific cases, an explanation is given for each status of the bit.
- Not all bits are used.

List of Objects

The table below presents the objects of the IODDT:

Standard symbol	Type	Access	Meaning	Address
MOD_ERROR	BOOL	R	Module error bit	%I.r.m.MOD.ERR
EXCH_STS	INT	R	Module exchange control word	%MWr.m.MOD.0
STS_IN_PROGR	BOOL	R	Reading of status words of the module in progress	%MWr.m.MOD.0.0
EXCH_RPT	INT	R	Exchange report word	%MWr.m.MOD.1
STS_ERR	BOOL	R	Error detected while reading module status words	%MWr.m.MOD.1.0
MOD_FLT	INT	R	Internal error word of the module	%MWr.m.MOD.2
MOD_FAIL	BOOL	R	Internal error, inoperable module	%MWr.m.MOD.2.0
CH_FLT	BOOL	R	Channel error detected	%MWr.m.MOD.2.1
BLK	BOOL	R	Terminal block error	%MWr.m.MOD.2.2
CONF_FLT	BOOL	R	Hardware or software configuration mismatch	%MWr.m.MOD.2.5
NO_MOD	BOOL	R	Module missing or inoperative	%MWr.m.MOD.2.6
EXT_MOD_FLT	BOOL	R	Internal error word of the module (Fipio extension only)	%MWr.m.MOD.2.7
MOD_FAIL_EXT	BOOL	R	Module is unserviceable (Fipio extension only)	%MWr.m.MOD.2.8
CH_FLT_EXT	BOOL	R	Channel error detected (Fipio extension only)	%MWr.m.MOD.2.9
BLK_EXT	BOOL	R	Terminal block error detected (Fipio extension only)	%MWr.m.MOD.2.10
CONF_FLT_EXT	BOOL	R	Hardware or software configuration mismatch (Fipio extension only)	%MWr.m.MOD.2.13
NO_MOD_EXT	BOOL	R	Module missing or inoperative (Fipio extension only)	%MWr.m.MOD.2.14



C

- channel data structure for all modules
 - IODDT, *111*
 - T_GEN_MOD, *102, 124*
- channel data structure for Fipway communication
 - T_COM_FPW, *115*
- common words, *64*
- compliance, *22*
- connecting
 - TSXFPP20, *37*
 - TSXSCY21601, *34*
- consumption
 - TSX FPP 20, *54*
 - TSXSCY21601, *36*

D

- diagnosing
 - TSX FPP 20, *50*
 - TSX SCY 21601, *32*
- diagnostics, *89*

F

- Fipway, *59*

I

- installing
 - TSXFPP20, *46*

M

- messaging, *62*

P

- parameter settings, *102*
- performances, *70*

S

- shared tables, *66*

T

- T_COM_FPW, *115*
- T_GEN_MOD, *124*
- topologies, *19*
- TSXFACC12, *52*
- TSXFACC4, *52*
- TSXFPCG010, *52*
- TSXFPCG030, *52*
- TSXFPP20, *52*
- TSXSCY21601, *23*

W

- wiring precautions, *53*

